

Programming Reference

Mobile Printer

PW208NX / PW208mNX

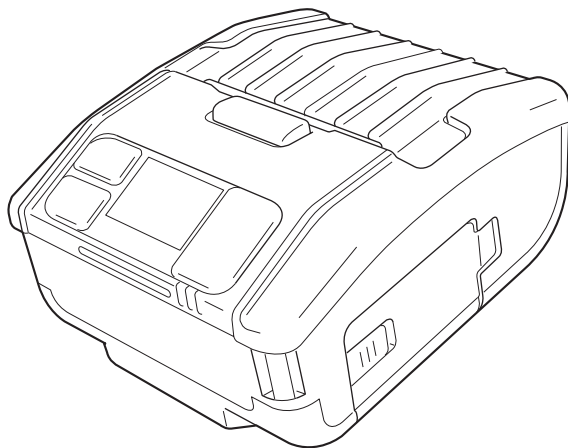
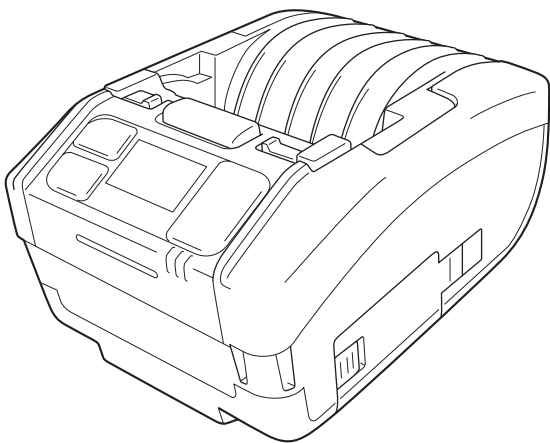

Copyrights

Any unauthorized reproduction of the contents of this document, in part or whole, is strictly prohibited.

Limitation of Liability

SATO Corporation and its subsidiaries in Japan, the U.S and other countries make no representations or warranties of any kind regarding this material, including, but not limited to, implied warranties of merchantability and fitness for a particular purpose. SATO Corporation shall not be held responsible for errors contained herein or any omissions from this material or for any damages, whether direct, indirect, incidental or consequential, in connection with the furnishing, distribution, performance or use of this material.

Specifications and contents in this document are subject to change without notice.

Trademarks

- SATO is a registered trademark of SATO Holdings Corporation and its subsidiaries in Japan, the U.S. and other countries.
- QR Code is a registered trademark of DENSO WAVE INCORPORATED.
- Wi-Fi[®], Wi-Fi logo and Wi-Fi Direct are registered trademarks of Wi-Fi Alliance.
- Windows is a registered trademark of Microsoft Corporation in the United States and/or other countries.
- Bluetooth is a trademark of Bluetooth SIG, Inc., U.S.A.
- WPA[™] and WPA2[™] are trademarks of Wi-Fi Alliance.
- Google Chrome is a trademark of Google Inc.
- All other trademarks are the property of their respective owners.

Table of Contents

Part 1 SBPL Commands.....	7
Command list.....	7
Font list.....	12
Example of Command reference.....	15
Control command.....	17
[ESC+A] Start Code.....	17
[ESC+Z] Stop Code.....	18
[ESC+Q] Print Quantity.....	19
[ESC+ID] Job ID Number.....	20
[ESC+WK] Job Name.....	21
Print Position Command.....	22
[ESC+H] Horizontal Print Position.....	22
[ESC+V] Vertical Print Position.....	23
Modification Command.....	24
[ESC+P] Character Pitch.....	24
[ESC+L] Enlargement.....	26
[ESC+PS] Proportional Pitch.....	27
[ESC+PR] Release Proportional Pitch.....	28
[ESC+%] Rotation.....	29
[ESC+F] Sequential number.....	31
[ESC+FW] Ruled / Grid Line Print.....	33
[ESC+FC] Print Circle.....	35
[ESC+FT] Print Triangle.....	37
[ESC+(] Reverse Color Print.....	39
[ESC+KC] Kanji Code.....	41
[ESC+&] Store Form Overlay.....	43
[ESC+/] Recall Form Overlay.....	45
[ESC+0] Partial Edit.....	46
[ESC+WD] Partial Copy.....	47
[ESC+J] Journal Print.....	49
[ESC+RF] Recall Font & Logo.....	50
[ESC+RM] Mirror Image.....	51
[ESC+KS] Kanji Set.....	53
[ESC+AL] Field alignment.....	54
Font command.....	59
[ESC+X20] X20 font (Basic size 5 x 9 dots).....	59

[ESC+X21] X21 font (Basic size 17 x 17 dots).....	61
[ESC+X22] X22 font (Basic size 24 x 24 dots).....	63
[ESC+X23] X23 font (Basic size 48 x 48 dots).....	65
[ESC+X24] X24 font (Basic size 48 x 48 dots).....	67
[ESC+XU] XU font (Basic size 5 x 9 dots).....	69
[ESC+XS] XS font (Basic size 17 x 17 dots).....	71
[ESC+XM] XM font (Basic size 24 x 24 dots).....	73
[ESC+XB] XB font (Basic size 48 x 48 dots).....	75
[ESC+XL] XL font (Basic size 48 x 48 dots).....	77
[ESC+OA] OCR-A font.....	79
[ESC+OB] OCR-B font.....	81
[ESC+U] U Font (Basic size 5 x 9 dots).....	83
[ESC+S] S Font (Basic size 8 x 15 dots).....	85
[ESC+M] M Font (Basic size 13 x 20 dots).....	87
[ESC+WB] WB Font (Basic size 18 x 30 dots).....	89
[ESC+WL] WL font (Basic size 28 x 52 dots).....	91
[ESC+\$] Outline Font Design.....	93
[ESC+\${}] Outline Font Print.....	95
[ESC+RD] CG Font.....	97
[ESC+RG] Multiple language.....	102
[ESC+RH] Scalable font.....	108
[ESC+K1] 16 x 16 dots Kanji in horizontal line.....	113
[ESC+K2] 24 x 24 dots Kanji in horizontal line.....	115
[ESC+K3] 22 x 22 dots Kanji in horizontal line.....	117
[ESC+K4] 32 x 32 dots Kanji in horizontal line.....	119
[ESC+K5] 40 x 40 dots Kanji in horizontal line.....	121
[ESC+K8] 16 x 16 dots Kanji in horizontal line with 1-byte character.....	123
[ESC+K9] 24 x 24 dots Kanji in horizontal line with 1-byte character.....	125
[ESC+KA] 22 x 22 dots Kanji in horizontal line with 1-byte character.....	127
[ESC+KB] 32 x 32 dots Kanji in horizontal line with 1-byte character.....	129
[ESC+KD] 40 x 40 dots Kanji in horizontal line with 1-byte character.....	131
[ESC+k1] 16 x 16 dots Kanji in vertical line.....	133
[ESC+k2] 24 x 24 dots Kanji in vertical line.....	135
[ESC+k3] 22 x 22 dots Kanji in vertical line.....	137
[ESC+k4] 32 x 32 dots Kanji in vertical line.....	139
[ESC+k5] 40 x 40 dots Kanji in vertical line.....	141
[ESC+k8] 16 x 16 dots Kanji in vertical line with 1-byte character.....	143
[ESC+k9] 24 x 24 dots Kanji in vertical line with 1-byte character.....	145
[ESC+kA] 22 x 22 dots Kanji in vertical line with 1-byte character.....	147
[ESC+kB] 32 x 32 dots Kanji in vertical line with 1-byte character.....	149
[ESC+kD] 40 x 40 dots Kanji in vertical line with 1-byte character.....	151
[ESC+T1] 16 x 16 dots external font registration.....	153
[ESC+T2] 24 x 24 dots external font registration.....	156

[ESC+K1(K2)] Recall horizontal writing external character.....	159
[ESC+k1(k2)] Recall vertical writing external character.....	161
[ESC+PP] POP Font (Basic size 80 x 133 dots).....	163
Barcode Command.....	165
[ESC+B] Barcode (Ratio 1:3).....	170
[ESC+D] Barcode (Ratio 1:2).....	173
[ESC+D] ~ [ESC+d] Barcode (with HRI).....	176
[ESC+BD] Barcode (Ratio 2:5).....	178
[ESC+BT] Barcode Ratio Registration.....	181
[ESC+BW] Barcode print by specified ratio.....	182
[ESC+BC] CODE 93 Barcode.....	186
[ESC+BF] UPC Add-on (Bookland).....	188
[ESC+BG] Code 128 Barcode.....	190
[ESC+BI] GS1-128 (UCC/EAN128) (Standard Carton ID Only).....	193
[ESC+BP] Postnet.....	196
[ESC+BS] USPS Barcode.....	198
[ESC+EU] Composite symbol.....	200
[ESC+BL] UPC-A Barcode (Without HRI).....	208
[ESC+BL] ~ [ESC+d] UPC-A Barcode (Specifying HRI).....	210
[ESC+BM] UPC-A Barcode (With HRI).....	212
2D Code.....	214
[ESC+2D10] PDF417.....	214
[ESC+2D12] Micro PDF417.....	217
[ESC+2D20] MaxiCode.....	220
[ESC+2D30] QR Code (Model 2).....	223
[ESC+2D31] QR Code (Model 1).....	228
[ESC+2D32] Micro QR Code.....	232
[ESC+2D50] DataMatrix (ECC200).....	235
[ESC+2D51] GS1 DataMatrix.....	239
[ESC+2D70] Aztec Code.....	244
[ESC+BQ] QR Code (Compatible command).....	248
[ESC+BV] MaxiCode (Compatible command).....	274
[ESC+BK] PDF417 (Compatible command).....	276
[ESC+BX] DataMatrix (ECC200) (Compatible command).....	280
[ESC+DC] DataMatrix (ECC200) Data Specify (Compatible command).....	281
[ESC+FX] DataMatrix (ECC200) Sequential Number (Compatible command).....	282
[ESC+QV] QR code version.....	284
Graphic Command.....	286
[ESC+G] Graphic Print.....	286
[ESC+GM] BMP File Print.....	288
[ESC+GP] PCX File Print.....	289

System Command	290
[ESC+CS] Print Speed.....	290
[ESC+#F] Print Darkness.....	292
[ESC+#E] Print Darkness (MB2i series compatible command).....	294
[ESC+A1] Media Size.....	296
[ESC+A3] Base Reference Point.....	299
[ESC+EP] Print End Position.....	301
[ESC+*] Memory Clear.....	304
[ESC+@] Offline.....	306
[ESC+C] Reprint.....	307
[ESC+E] Auto Line Feed.....	308
[ESC+PG] Designation of Registration on Printer Motion (MB2i series compatible command).....	310
[ESC+PO] Offset.....	314
[ESC+IG] Sensor Type.....	315
[ESC+PM] Print mode.....	316
[ESC+KM] Mincho (Kanji).....	318
[ESC+KG] Gothic (Kanji).....	319
[ESC+CE] European code page.....	320
[ESC+TK] Forced Tear Off.....	322
[ESC+TW] Option Waiting Time.....	323
[ESC+CL] Delete CR/LF.....	324
Intelligent Command	325
[ESC+IK] Label Feed Control.....	325
Common commands for all languages	327
[DC2+PA] Printer setting command.....	328
[DC2+PB] Printer setting information acquisition.....	351
[DC2+PC] Printer device information acquisition.....	354
[DC2+PD] Each sensor information acquisition.....	361
[DC2+PG] Printer status information acquisition.....	364
[DC2+PH] Cancel request.....	368
[DC2+PI] Application change.....	369
[DC2+DB] Initialization.....	371
[DC2+DC] Reset.....	374
[DC2+DD] Power OFF.....	375
[DC2+DE] File download.....	376
[DC2+DF] File name information acquisition.....	379
[DC2+DG] File information acquisition.....	382
[DC2+DH] File deletion.....	385
Time zone list	387

Part 2 Interface Specification..... 393

Overview.....	393
Overview.....	393
Communication protocol.....	394
Types of communication protocol and Reception mode.....	394
Return status.....	395
Return status of Status 3.....	396
Return status of Status 4.....	400
Status 3.....	405
Return sequence.....	406
Reference flow chart.....	408
Status 4.....	409
Return sequence.....	410
USB.....	412
Basic Specifications.....	412
Layout plan for connector pin.....	413
Wireless LAN.....	414
Basic Specifications.....	414
Network setting/Display items.....	417
Wireless LAN setting/Display items.....	419
Specifications of software.....	422
Specifications of TCP/IP.....	422
Specifications of LPR.....	422
Specifications of FTP.....	422
Specifications of HTTP/HTTPS.....	423
Wireless LAN settings.....	425
802.1x authentication and certification.....	425
Socket communication.....	427
Connection and Disconnection of session.....	428
Printer Status.....	430
Specification of SNMP.....	432
PrinterMIB / HostResourceMIB to show the status of printer.....	433
Notes.....	437
Bluetooth.....	438
Basic specification.....	438
Bluetooth settings.....	441
CRC transmission data.....	442
CRC calculation data.....	443

Example of transmission data.....	444
CRC error display.....	445
Transmission sequence.....	446
Normal end.....	446
In case where communication is lost while transferring print data.....	450
In case where communication is lost while transferring status after receiving print data.....	451
Abnormal end when CRC check is enabled.....	452
NFC.....	453
Basic specification.....	453
Tag mode.....	455
Data format.....	456
Transmission sequence.....	457
Pass-through mode.....	458
Data format.....	459
Transmission sequence.....	460
Handover mode.....	466
Notes about the Interface.....	467

Part 1 SBPL Commands

Command list

Control

Command		Function
ESC+A	<A>	Start Code
ESC+Z	<Z>	Stop Code
ESC+Q	<Q>	Print Quantity
ESC+ID	<ID>	Job ID Number
ESC+WK	<WK>	Job Name

Print position

Command		Function
ESC+H	<H>	Horizontal Print Position
ESC+V	<V>	Vertical Print Position

Modification

Command		Function
ESC+P	<P>	Character Pitch
ESC+L	<L>	Enlargement
ESC+PS	<PS>	Proportional Pitch
ESC+PR	<PR>	Release Proportional Pitch
ESC+%	<%>	Rotation
ESC+F	<F>	Sequential Number
ESC+FW	<FW>	Ruled/Grid Line Print
ESC+FC	<FC>	Print of Circles
ESC+FT	<FT>	Print Triangles
ESC+(<()>	Reverse Color Print
ESC+KC	<KC>	Kanji Code
ESC+&	<&>	Store Form Overlay
ESC+/ </>	</>	Recall Form Overlay
ESC+0	<0>	Partial Edit
ESC+WD	<WD>	Partial Copy

Command		Function
ESC+J	<J>	Journal Print
ESC+RF	<RF>	Recall Font & Logo
ESC+RM	<RM>	Mirror Image
ESC+KS	<KS>	Kanji set
ESC+AL	<AL>	Field alignment

Font

Command		Function
ESC+X20	<X20>	X20 font (Basic size 5x9 dots)
ESC+X21	<X21>	X21 font (Basic size 17x17 dots)
ESC+X22	<X22>	X22 font (Basic size 24x24 dots)
ESC+X23	<X23>	X23 font (Basic size 48x48 dots)
ESC+X24	<X24>	X24 font (Basic size 48x48 dots)
ESC+XU	<XU>	XU font (Basic size 5x9 dots)
ESC+XS	<XS>	XS font (Basic size 17x17 dots)
ESC+XM	<XM>	XM font (Basic size 24x24 dots)
ESC+XB	<XB>	XB font (Basic size 48x48 dots)
ESC+XL	<XL>	XL font (Basic size 48x48 dots)
ESC+OA	<OA>	OCR-A font
ESC+OB	<OB>	OCR-B font
ESC+U	<U>	U font
ESC+S	<S>	S font
ESC+M	<M>	M font
ESC+WB	<WB>	WB font
ESC+WL	<WL>	WL font
ESC+\$	<\$>	Outline Font design
ESC+\$=	<\$=>	Outline Font print
ESC+RD	<RD>	CG font
ESC+RG	<RG>	Multiple language
ESC+RH	<RH>	Scalable font
ESC+K1	<K1>	16x16 dots Kanji in horizontal line
ESC+K2	<K2>	24x24 dots Kanji in horizontal line
ESC+K3	<K3>	22x22 dots Kanji in horizontal line
ESC+K4	<K4>	32x32 dots Kanji in horizontal line
ESC+K5	<K5>	40x40 dots Kanji in horizontal line
ESC+K8	<K8>	16x16 dots Kanji in horizontal line with 1-byte character

Command		Function
ESC+K9	<K9>	24x24 dots Kanji in horizontal line with 1-byte character
ESC+KA	<KA>	22x22 dots Kanji in horizontal line with 1-byte character
ESC+KB	<KB>	32x32 dots Kanji in horizontal line with 1-byte character
ESC+KD	<KD>	40x40 dots Kanji in horizontal line with 1-byte character
ESC+k1	<k1>	16x16 dots Kanji in vertical line
ESC+k2	<k2>	24x24 dots Kanji in vertical line
ESC+k3	<k3>	22x22 dots Kanji in vertical line
ESC+k4	<k4>	32x32 dots Kanji in vertical line
ESC+k5	<k5>	40x40 dots Kanji in vertical line
ESC+k8	<k8>	16x16 dots Kanji in vertical line with 1-byte character
ESC+k9	<k9>	24x24 dots Kanji in vertical line with 1-byte character
ESC+kA	<kA>	22x22 dots Kanji in vertical line with 1-byte character
ESC+kB	<kB>	32x32 dots Kanji in vertical line with 1-byte character
ESC+kD	<kD>	40x40 dots Kanji in vertical line with 1-byte character
ESC+T1	<T1>	16x16 dots external font registration
ESC+T2	<T2>	24x24 dots external font registration
ESC+K1(K2)	<K1(K2)>	Recall horizontal writing external character
ESC+k1(k2)	<k1(k2)>	Recall vertical writing external character
ESC+PP	<PP>	POP Font

Barcode

Command		Function
ESC+B		Barcode (Ratio 1:3)
ESC+D	<D>	Barcode (Ratio 1:2)
ESC+D~ESC+d	<D>~<d>	Barcode (with HRI)
ESC+BD	<BD>	Barcode (Ratio 2:5)
ESC+BT	<BT>	Barcode Ratio Registration
ESC+BW	<BW>	Barcode Print by Specified ratio
ESC+BC	<BC>	CODE93 Barcode
ESC+BF	<BF>	UPC Add-on (Bookland)
ESC+BG	<BG>	CODE128 Barcode
ESC+BI	<BI>	GS1-128 (UCC/EAN128)(Standard Carton ID Only)
ESC+BP	<BP>	Postnet
ESC+BS	<BS>	USPS Barcode
ESC+EU	<EU>	Composite Symbol
ESC+BL	<BL>	UPC-A Barcode (Without HRI)

Command		Function
ESC+BL~ESC+d	<BL>~<d>	UPC-A Barcode (Without HRI)
ESC+BM	<BM>	UPC-A Barcode (with HRI)

2D Barcode

Command		Function
ESC+2D10	<2D10>	PDF417
ESC+2D12	<2D12>	Micro PDF417
ESC+2D20	<2D20>	MaxiCode
ESC+2D30	<2D30>	QR Code (Model 2)
ESC+2D31	<2D31>	QR Code (Model 1)
ESC+2D32	<2D32>	Micro QR Code
ESC+2D50	<2D50>	DataMatrix (ECC200)
ESC+2D51	<2D51>	GS1 DataMatrix
ESC+2D70	<2D70>	Aztec Code
ESC+BQ	<BQ>	QR code version
ESC+BV	<BV>	MaxiCode
ESC+BK	<BK>	PDF417
ESC+BX	<BX>	DataMatrix(ECC200)
ESC+DC	<DC>	DataMatrix (ECC200) Data Specify
ESC+FX	<FX>	DataMatrix (ECC200) Sequential Number
ESC+QV	<QV>	QR code version

Graphic

Command		Function
ESC+G	<G>	Graphic print
ESC+GM	<GM>	BMP File Print
ESC+GP	<GP>	PCX File Print

System

Command		Function
ESC+CS	<CS>	Print Speed
ESC+#F	<#F>	Print Darkness
ESC+#E	<#E>	Print Darkness (MB2i series compatible command)
ESC+A1	<A1>	Media Size
ESC+A3	<A3>	Base Reference Point
ESC+EP	<EP>	Print End Position

Command		Function
ESC+*	<*>	Memory Clear
ESC+@	<@>	Offline
ESC+C	<C>	Reprint
ESC+E	<E>	Auto Line Feed
ESC+PG	<PG>	Registration of Printer Operation (MB2i series compatible command)
ESC+PO	<PO>	Offset
ESC+IG	<IG>	Sensor Type
ESC+PM	<PM>	Print Mode
ESC+KM	<KM>	Mincho (Kanji)
ESC+KG	<KG>	Gothic (Kanji)
ESC+CE	<CE>	European code page
ESC+TK	<TK>	Forced Tear Off
ESC+TW	<TW>	Option Waiting Time
ESC+CL	<CL>	Delete CR/LF

Intelligent

Command		Function
ESC+IK	<IK>	Label Feed Control

Common commands for all languages

Command		Function
DC2+PA		Printer setting
DC2+PB		Printer information acquisition
DC2+PC		Printer device information acquisition
DC2+PD		Each sensor information acquisition
DC2+PG		Printer status information acquisition
DC2+PH		Cancel request
DC2+PI		Application change
DC2+DB		Initialization
DC2+DC		Reset
DC2+DD		Power off
DC2+DE		File download
DC2+DF		File name information acquisition
DC2+DG		File information acquisition
DC2+DH		File deletion

Font list

Specify ESC + (relevant font command) to use residential fonts.

Font	Font type	Pitch
OCR-A (8 dots/mm)	Bitmap [OCR-A font] 15×22 dots	Fixed
OCR-B (8 dots/mm)	Bitmap [OCR-B font] 20×24 dots	Fixed
XU	Bitmap [Helvetica] 5×9 dots	Fixed / Proportional
XS	Bitmap [Universe Condensed Bold] 17×17 dots	Fixed / Proportional
XM	Bitmap [Universe Condensed Bold] 24×24 dots	Fixed / Proportional
XB	Bitmap [Universe Condensed Bold] 48×48 dots	Fixed / Proportional
XL	Bitmap [Sans Serif] 48×48 dots	Fixed / Proportional
X20	Bitmap [X20 font] 5×9 dots	Fixed
X21	Bitmap [X21 font] 17×17 dots	Fixed / Proportional
X22	Bitmap [X22 font] 24×24 dots	Fixed / Proportional
X23	Bitmap [X23 font] 48×48 dots	Fixed / Proportional
X24	Bitmap [X24 font] 48×48 dots	Fixed / Proportional
U	Bitmap [U font] 5×9 dots	Fixed
S	Bitmap [S font] 8×15 dots	Fixed
M	Bitmap [M font] 13×20 dots	Fixed
WB	Bitmap [WB font] 18×30 dots	Fixed
WL	Bitmap [WL font] 28×52 dots	Fixed
K1(k1)	Bitmap [Kanji font] 16×16 dots	Fixed
K2(k2)	Bitmap [Kanji font] 24×24 dots	Fixed
K3(k3)	Bitmap [Kanji font] 22×22 dots	Fixed
K4(k4)	Bitmap [Kanji font] 32×32 dots	Fixed
K5(k5)	Bitmap [Kanji font] 40×40 dots	Fixed
PP	Bitmap [POP font] 80×133 dots	Fixed / Proportional
\$(shape)	Outline font	Fixed / Proportional
\$(print)	Kanji Outline font	Fixed
RD	CG font [SATO CG Sleek]	Fixed / Proportional
	CG font [SATO CG Stream]	Fixed / Proportional
RG	Multiple language font	Fixed / Proportional
RH	Scalable font	Fixed / Proportional

Expanded font

Font can be expanded by a factor of 1 to 36.

Internal bitmap fonts can also be expanded with a factor of 1 to 36.

Example: A font in a size of 5 dots of width and 9 dots of height is expanded by a factor of 3. The resulting font has a width of 15 dots and a height of 27 dots.

The input of enlargement ratio (height x enlargement ratio, width x enlargement ratio) for characters to be printed is done as described below:

Width x expansion factor= width parameter setting value

Height x expansion factor= height parameter setting value

The command <L> decides the expansion of the character. This parameter is set as factor.

Example: If setting the factor to: <L>0304, the character is expanded by a factor of 3 in horizontal direction (width) and a factor of 4 in vertical direction (height).

If an expansion factor is specified, also the pitch between the characters is automatically determined.

Fixed pitch / proportional pitch

There are fonts which can select both the fixed pitch and the proportional pitch. You can set the proportional pitch by <PS> command and release it by <PR> command on the printer screen.

Depending on the font type, the width of the proportional pitch does differ. Kata-kana is not affected by the proportional pitch, but the side space of characters will be narrowed.

At the fixed pitch, the character width is according to the relevant font size selected.

Difference between outline font and bitmap font

Regarding the bitmap font, the height and the width of the font are predefined. The height of the bitmap font is a little bit larger than the width.

The bitmap font is the largest in the font matrix.

For the font type and size refer to the font list previously described.

Regarding the outline font, if the height and the width of the font are set properly, the smooth scaling algorithm of the printer allows a well-balanced font. It is also possible to define some style options like a gray scale and a shadow setting.

Setting change of Eurocode

See below for the valid range of font command and Eurocode and Code Page that is enabled when you change the Eurocode settings in GUI or DC2 commands.

The values for ESC, ENQ, SOH, STX, ETX, CAN, DEL, DC1, DC2 in standard mode and ESC, ENQ, SOH, STX, ETX, CAN, DEL, DC1, DC2 in non-standard mode is out of valid range.

Command	Command name	The range of Eurocode	Code Page
<XU>	XU font (Basic size 5×9 dots)	Eurocode shall be 00H-FFH for compatibility.	DOS 857
<XS>	XS font (Basic size 17×17 dots)		DOS 858
<XM>	XM font (Basic size 24×24 dots)		For compatibility
<XB>	XB font (Basic size 48×48 dots)		
<XL>	XL font (Basic size 48×48 dots)		DOS 737 DOS 852

Command	Command name	The range of Eurocode	Code Page
<U>	U font (Basic size 5×9 dots)		DOS 866
<S>	S font (Basic size 8×15 dots)		
<M>	M font (Basic size 13×20 dots)		
<WB>	WB font (Basic size 18×30 dots)		
<WL>	WL font (Basic size 28×52 dots)		
<\$=>	Outline Font Print		
<RD>	CG font	Eurocode shall be 00H-FFH considering the use of GID (Glyph Index).	DOS 857 DOS 858
<RG>	Multiple language	Eurocode shall be 20H-FFH because the range of character code is more than 20H. Note: A space will be printed in case if less than 20H is specified.	
<RH>	Scalable font	Eurocode shall be 00H-FFH considering the use of GID (Glyph Index).	

Limitation on non-standard codes

Non-standard codes are available only in its default setting (Refer to the following chart). If control code is set to the same code as high-order bytes of Kanji by changing the code intentionally, it is not possible to use half-size characters which correspond to control code.

Functionality	Description	Initial value	
		Standard	Non-standard
Protocol code	STX	02H	7BH
	ETX	03H	7DH
	ESC	1BH	5EH
	ENQ	05H	40H
	CAN	18H	21H

Example of Command reference

1
2
 ↓ ↓
[ESC+L] Enlargement

3	Hexadecimal code	ESC	L	Parameter ←
		<1B> ₁₆	<4C> ₁₆	aabb
5	Initial value	aa=01, bb=01		
6	Valid range and term of command	When the power is OFF	The set parameter is not maintained.	
		Valid range within items	The set parameter is valid until the next valid setting.	
		Valid range between items	The set parameter becomes initial value at the next item <A>.	

7 **[Function]**
Specifying the enlargement ratio of font.

8 **[Format]**
<L>aabb
 • Parameter
 a [Horizontal enlargement ratio] = Valid range: 01 to 36
 b [Vertical enlargement ratio] = Valid range: 01 to 36

9 **[Coding Example]**
 Horizontal enlargement ratio: 4 times, Vertical enlargement ratio: 3 times
 <A>
 <V>100<H>200<P>3<L>**0403**<XM>ABCD
 <Q>2
 <Z>

10 **[Supplementary Explanation]**
 • Enlarges the character pitch as well. When Character Pitch <P> is used at the same time, the parameter value of horizontal enlargement ratio specified in Enlargement <L> will be reflected in the subsequent specification <P>.

11 **[Note]**
 • If increasing the enlargement ratio, design the print format that does not exceed print area.

12 **[Valid Command]**

Font	<XU>	<XS>	<XM>	<XB>	<XL>	<OA>	<OB>	<K1>	<K2>	<K3>
	<K4>	<K5>	<K8>	<K9>	<KA>	<KB>	<KD>	<k1>	<k2>	<k3>
	<k4>	<k5>	<k8>	<k9>	<kA>	<kB>	<kD>	<U>	<S>	<M>
	<WB>	<WL>	<X20>	<X21>	<X22>	<X23>	<X24>	<PP>		
Modification	<P>	<RF>								
Graphic	<G>	<GM>	<GP>							

1. Indicates command code.
2. Indicates command name.
3. Indicates command in Hexadecimal code.
4. Indicates parameter to be described in command.
5. Indicates initial value for command.
6. Indicates valid range of command.
 - When power is OFF;
 - The set parameter is maintained.
 - The set parameter is not maintained.
 - The set command is not maintained.

- Valid range within item;
 - The set parameter is valid until the next specification is made.
 - The set parameter becomes invalid.
 - The set command becomes invalid.
 - Valid range between items;
 - The set parameter becomes initial value at the next item <A>.
 - The set parameter is valid until the next specification is made.
 - The set parameter becomes invalid.
 - The set command becomes invalid.
7. Explains the function of command.
 8. Explains the command and required parameter.
 <L>AABB indicates the command ESC+L (<1B>₁₆<4C>₁₆) and two types of parameters such as "aa" and "bb".
 9. Shows the example of how the command is used.
 This is the coding example programmed in BASIC output to the printer connected with RS-232C.

```

10 ESC$=CHR$(&H1B)
20 OPEN "COM1:9600,N,8,1,RS,BIN" FOR OUTPUT AS #1
30 PRINT #1,ESC$;"A";
40 PRINT #1,ESC$;"V100";ESC$;"H200";
50 PRINT #1,ESC$;"P3";ESC$;"L0403";
60 PRINT #1,ESC$;"XMABCD";
70 PRINT #1,ESC$;"Q2";
80 PRINT #1,ESC$;"Z";
90 CLOSE #1
100 END

```
 10. Provides the supplemental information of command function and parameter.
 11. Provides notes and restriction for the use of command.
 12. Shows the commands that come under the influence of used commands.

Control command

[ESC+A] Start Code

Hexadecimal code	ESC	A	Parameter
	<1B> ₁₆	<41> ₁₆	Nil
Initial value	Nil		

Valid range and term of command	When the power is OFF	The set command is not maintained.
	Valid range within items	The set command becomes invalid.
	Valid range between items	The set command becomes invalid.

[Function]

Specifying the start of data transmission.

[Format]

<A>

[Coding Example]

<A>
<V>100<H>200<P>2<L>0202<XM>ABCD
<Q>2
<Z>

[Supplementary Explanation]

- Indicates the start of item and to be placed at the head of item.
- Use <A> and End of Data Transmission <Z> as a pair of commands.

[Note]

- Setting value of all commands excluding a part of system commands will be set to default.
- If this command is not specified, printing will not be performed.

[ESC+Z] Stop Code

Hexadecimal code	ESC	Z	Parameter
	<1B> ₁₆	<5A> ₁₆	Nil
Initial value	Nil		

Valid range and term of command	When the power is OFF	The set command is not maintained.
	Valid range within items	The set command becomes invalid.
	Valid range between items	The set command becomes invalid.

[Function]

Specifying the end of data transmission.

[Format]

<Z>

[Coding Example]

<A>
<V>100<H>200<P>2<L>0202<XM>ABCD
<Q>2
<Z>

[Supplementary Explanation]

- Indicates the end of item and to be placed at the tail of item.
- Use Start of Data Transmission <A> and <Z> as a pair of commands.

[Note]

- If this command is not specified, printing will not be performed.

[ESC+Q] Print Quantity

Hexadecimal code	ESC	Q	Parameter
	<1B> ₁₆	<51> ₁₆	aaaa
Initial value	aaaa=1		

Valid range and term of command	When the power is OFF	The set parameter is not maintained.
	Valid range within items	The set parameter becomes invalid.
	Valid range between items	The set parameter becomes invalid.

[Function]

Specifying the number of labels to print.

[Format]

<Q>aaaa

- Parameter

a [Number of labels to print] = Valid range: 1 to 9999

[Coding Example]

Number of labels: 2

<A>

<V>100<H>200<P>2<L>0202<XM>ABCD

<Q>2

<Z>

[Supplementary Explanation]

- Print contents specified by Start of Data Transmission <A> and End of Data Transmission <Z> are regarded as 1 label, and the number of reprints can be specified.
- Use this command prior to End of Data Transmission <Z>.

[Note]

- Reprint will be performed based on the specified print quantity. If specifying sequential numbering command <F>, the value of sequential number that was set up for that field portion will be printed.
- When this command is used in combination with Multiple Cutting <~>, the specified print quantity multiplied by specified value for cutting becomes the number of labels to print.

[ESC+ID] Job ID Number

Hexadecimal code	ESC	ID	Parameter
	<1B> ₁₆	<49> ₁₆ <44> ₁₆	aa
Initial value	a=<20> ₁₆		

Valid range and term of command	When the power is OFF	The set parameter is not maintained.
	Valid range within items	The set parameter is valid until the next valid setting.
	Valid range between items	The set command becomes invalid.

[Function]

Specifying job ID number for status return.

[Format]

<ID>aa

- Parameter

a [Job ID number]

Valid range:

00 to 99 (2 digits)

[Coding Example]

Job ID number: 01

<A>

<ID>01

<V>200<H>100<P>0<\$>B,100,100,6

<\$>SATOPRINTER

<Q>2

<Z>

[Supplementary Explanation]

- When status return is used for interface protocol, the specified job ID number can be set to the telegraphic status.
- Status can be confirmed by sending status request (ENQ).
- Include this command within items and use between start code <A> and stop code <Z>.

[Note]

- In status return interface protocol, this command becomes valid when status request (ENQ) is received while printing (QTY≠0, includes at the time of Offline and Error).
- In status return communication protocol, if status request (ENQ) is received when printing is not in progress (QTY=0, No received data when power is ON), space (20H) will be set to status and returned.
- When Job ID Number <ID> is used more than twice within the items of <A> and <Z>, the last specified value becomes valid.

[ESC+WK] Job Name

Hexadecimal code	ESC	WK	Parameter
	<1B> ₁₆	<57> ₁₆ <4B> ₁₆	aaaaaaaaaaaaaaaa
Initial value	aaaaaaaaaaaaaaaa=<20> ₁₆		

Valid range and term of command	When the power is OFF	The set parameter is not maintained.
	Valid range within items	The set parameter is valid until the next valid setting.
	Valid range between items	The set command becomes invalid.

[Function]

Specifying job name for status return.

[Format]

<WK>aaaaaaaaaaaaaaaa

- Parameter

a [Job Name] = ASCII code 16-digit, Shift JIS Kanji 8-digit

[Coding Example]

Job name: SATO

<A>

<ID>01

<WK>SATO

<V>200<H>100<P>0<\$>B,100,100,6

<\$=>SATOPRINTER

<Q>2

<Z>

[Supplementary Explanation]

- When Status 4 is used for interface protocol, specified job name can be set to the telegraphic status.
- Status can be confirmed sending status request (ENQ).
- Include this command within items and use between start code <A> and stop code <Z>.
- This command can be used in combination with Job ID Number <ID>.

[Note]

- In status return interface protocol, this command becomes valid when status request (ENQ) is received while printing (QTY≠0, includes at the time of Offline and Error).
- In status return communication protocol, if status request (ENQ) is received when printing is not in progress (QTY=0, No received data when power is ON), space (20H) will be set to status and returned.
- When Job ID Number <ID> is used more than twice within the items of <A> and <Z>, the last specified value becomes valid.
- For more information, refer to the "Interface Specifications".

Print Position Command

[ESC+H] Horizontal Print Position

Hexadecimal code	ESC	H	Parameter
	<1B> ₁₆	<48> ₁₆	aaaa
Initial value	aaaa=1		

Valid range and term of command	When the power is OFF	The set parameter is not maintained.
	Valid range within items	The set parameter is valid until the next valid setting.
	Valid range between items	The set parameter becomes initial value at the next item <A>.

[Function]

Specifying horizontal print position from its start point by dot.

[Format]

<H>aaaa

- Parameter

a [Horizontal Print Position] = Refer to the table below.

[Coding Example]

Horizontal print position: 200 dots

```
<A>
<V>100<H>200<P>2<L>0202<XM>ABCD
<Q>2
<Z>
```

[Supplementary Explanation]

- Specifying the start of horizontal position for the print of text, barcode, ruled line and graphic.

[Note]

- Any contents such as text, barcode, graphic exceed printing area will not be printed.

[Initial Value and Valid Range of Parameter]

Head density	Initial value	Valid range (dots)
203 dpi	1	1 to 440

[ESC+V] Vertical Print Position

Hexadecimal code	ESC	V	Parameter
	<1B> ₁₆	<56> ₁₆	aaaaa
Initial value	aaaaa=1		

Valid range and term of command	When the power is OFF	The set parameter is not maintained.
	Valid range within items	The set parameter is valid until the next valid setting.
	Valid range between items	The set parameter becomes initial value at the next item <A>.

[Function]

Specifying vertical print position from its start point by dot.

[Format]

<V>aaaaa

- Parameter

a [Vertical Print Position] = Refer to the table below.

[Coding Example]

Vertical print position: 100 dots

<A>

<V>100<H>200<P>2<L>0202<XM>ABCD

<Q>2

<Z>

[Supplementary Explanation]

- Specifying the start of vertical position for the print of text, barcode, ruled line and graphics.

[Note]

- Any contents such as text, barcode and graphic exceed printing area will not be printed.

[Initial Value and Valid Range of Parameter]

Head density	Initial value	Valid range (dots)
203 dpi	1	1 to 8000

Modification Command

[ESC+P] Character Pitch

Hexadecimal code	ESC	P	Parameter
	<1B> ₁₆	<50> ₁₆	aa
Initial value	aa=02		

Valid range and term of command	When the power is OFF	The set parameter is not maintained.
	Valid range within items	The set parameter is valid until the next valid setting.
	Valid range between items	The set parameter becomes initial value at the next item <A>.

[Function]

Specifying character pitch by dot.

[Format]

<P>aa

- Parameter

a [Character pitch] = Valid range: 00 to 99 dots

[Coding Example]

Character pitch: 10

```
<A>
<V>200<H>100<P>10<L>0202<XM>ABCD
<Q>2
<Z>
```

[Supplementary Explanation]

- Character pitch means the character gap or font gap when selecting font or barcode.
- Specified character pitch will be widened based on the ratio of Enlargement <L>.
- Even if linefeed code [CR] is specified in Auto Linefeed <E>, the character pitch remains the same without returning to initial value. Start of Data Transmission <A> can be used to reset to the initial value.
- By specifying Character Pitch <P> just before the barcode specification, pitch command becomes valid for barcode module.
Object barcode: NW-7, CODE39, Industrial 2of5, Matrix 2of5
For more information, see (3) Intercharacter gap in [Barcode Command].
- Data specification except numeric value or specification of over-digit will give the initial value.

[Valid Commands]

Font	<XU>	<XS>	<XM>	<XB>	<XL>	<OA>	<OB>	<RD>	<\$=>	<K1>
	<K2>	<K3>	<K4>	<K5>	<K8>	<K9>	<KA>	<KB>	<KD>	<k1>
	<k2>	<k3>	<k4>	<k5>	<k8>	<k9>	<kA>	<kB>	<kD>	<U>
	<S>	<M>	<WB>	<WL>	<X20>	<X21>	<X22>	<X23>	<X24>	<PP>
Barcode		<D>	<D><d>	<BD>	<BT>	<BW>	<BM>			
Modification	<RF>									

[ESC+L] Enlargement

Hexadecimal code	ESC	L	Parameter
	<1B> ₁₆	<4C> ₁₆	aabb
Initial value	aa=01, bb=01		

Valid range and term of command	When the power is OFF	The set parameter is not maintained.
	Valid range within items	The set parameter is valid until the next valid setting.
	Valid range between items	The set parameter becomes initial value at the next item <A>.

[Function]

Specifying the enlargement ratio of font.

[Format]

<L>aabb

- Parameter
 - a [Horizontal enlargement ratio] = Valid range: 01 to 36
 - b [Vertical enlargement ratio] = Valid range: 01 to 36

[Coding Example]

Horizontal enlargement ratio: 4 times, Vertical enlargement ratio: 3 times

```
<A>
<V>100<H>200<P>3<L>0403<XM>ABCD
<Q>2
<Z>
```

[Supplementary Explanation]

- Enlarges the character pitch as well. When Character Pitch <P> is used at the same time, the parameter value of horizontal enlargement ratio specified in Enlargement <L> will be reflected in the subsequent specification <P>.

[Note]

- If increasing the enlargement ratio, design the print format that does not exceed printing area.

[Valid Commands]

Font	<XU>	<XS>	<XM>	<XB>	<XL>	<OA>	<OB>	<K1>	<K2>	<K3>
	<K4>	<K5>	<K8>	<K9>	<KA>	<KB>	<KD>	<k1>	<k2>	<k3>
	<k4>	<k5>	<k8>	<k9>	<kA>	<kB>	<kD>	<U>	<S>	<M>
	<WB>	<WL>	<X20>	<X21>	<X22>	<X23>	<X24>	<PP>		
Modification	<P>	<RF>								
Graphic	<G>	<GM>	<GP>							

[ESC+PS] Proportional Pitch

Hexadecimal code	ESC	PS	Parameter
	<1B> ₁₆	<50> ₁₆ <53> ₁₆	Nil
Initial value	Nil		

Valid range and term of command	When the power is OFF	The set command is not maintained.
	Valid range within items	The set parameter is valid until the next valid setting.
	Valid range between items	The set parameter becomes initial value at the next item <A>.

[Function]

Specifying the proportional pitch.

[Format]

<PS>

[Coding Example]

<A>
<PS>
 <V>100<H>200<P>2<L>0202<XM>ABCD
 <Q>2
 <Z>

[Supplementary Explanation]

- If data other than specified is set, proportional print will not be performed.
- Neither Proportional Pitch <PS> nor Release Proportional Pitch <PR> is set as Initial value.

[Valid Commands]

Font	<XU>	<XS>	<XM>	<XB>	<XL>	<RD>	<RG>	<RH>	<PP>	<X20>
	<X21>	<X22>	<X23>	<X24>	<\$><=\$=>					
Modification	<RF>									

[ESC+PR] Release Proportional Pitch

Hexadecimal code	ESC	PS	Parameter
	<1B> ₁₆	<50> ₁₆ <52> ₁₆	Nil
Initial value	Nil		

Valid range and term of command	When the power is OFF	The set command is not maintained.
	Valid range within items	The set parameter is valid until the next valid setting.
	Valid range between items	The set parameter becomes initial value at the next item <A>.

[Function]

Specifying the release of proportional pitch.

[Format]

<PR>

[Coding Example]

<A>
<PR>
 <V>100<H>200<P>2<L>0202<XM>ABCD
 <Q>2
 <Z>

[Supplementary Explanation]

- Neither Proportional Pitch <PS> nor Release Proportional Pitch <PR> is set as Initial value.

[Valid Commands]

Font	<XU>	<XS>	<XM>	<XB>	<XL>	<RD>	<RG>	<RH>	<PP>	<X21>
	<X22>	<X23>	<X24>	<\$><=\$>						
Modification	<RF>									

[ESC+%] Rotation

Hexadecimal code	ESC	%	Parameter
	<1B> ₁₆	<25> ₁₆	a
Initial value	a=0		

Valid range and term of command	When the power is OFF	The set parameter is not maintained.
	Valid range within items	The set parameter is valid until the next valid setting.
	Valid range between items	The set parameter becomes initial value at the next item <A>.

[Function]

Specifying the counter-clockwise rotation of font and barcode.

[Format]

<%>a

- Parameter
 - a [Rotative direction]
 - 0: Parallel 1 (0 degree)
 - 1: Serial 1 (90-degree)
 - 2: Parallel 2 (180-degree)
 - 3: Serial 2 (270-degree)

[Coding Example]

Font rotation: Parallel 2 (180-degree), Barcode rotation: Serial 1 (90-degree)

```
<A>
<%>2
<V>100<H>400<P>3<L>0403<XM>ABCD
<%>1
<V>400<H>200<BD>103160*123*
<Q>2
<Z>
```

[Supplementary Explanation]

- Position specification of Vertical Print Position <V> and Horizontal Print Position <H> are the absolute value from its base reference point.
- When the value of parameter "a" is between 4 and 9, it will be processed as a command error and ignored. When the value other than numeric is specified, this will be ignored and printing will be performed at 0 degree.
- Print of barcode using Serial 1 or Serial 2 may cause blur. Drop the print speed for rotation print of Serial 1 and Serial 2 for better performance.

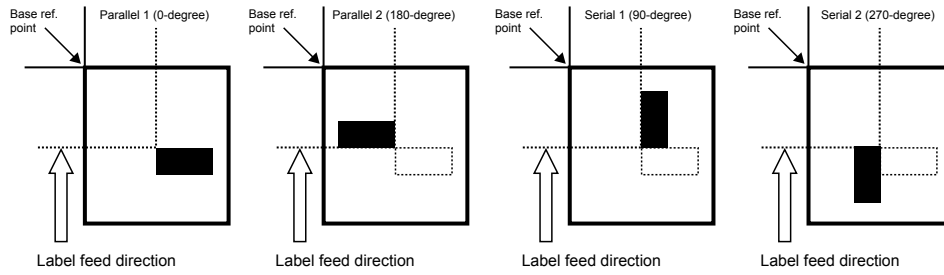

[Valid Commands]

Font	<XU>	<XS>	<XM>	<XB>	<XL>	<OA>	<OB>	<RD>	<\$=>	<K1>
	<K2>	<K3>	<K4>	<K5>	<K8>	<K9>	<KA>	<KB>	<KD>	<k1>
	<k2>	<k3>	<k4>	<k5>	<k8>	<k9>	<kA>	<kB>	<kD>	<U>
	<S>	<M>	<WB>	<WL>	<X20>	<X21>	<X22>	<X23>	<X24>	<PP>
Barcode		<BC>	<BG>	<BI>	<D>	<D><d>	<BD>	<BT>	<BW>	<BP>
	<BF>	<BS>	<BL>	<BL><d>	<BM>					
2D code	<2D10>	<BK>	<2D12>	<2D20>	<BV>	<2D30>	<2D31>	<2D32>	<BQ>	<2D50>
	<BX>	<2D51>	<2D70>							
Composite Symbol	<EU>									
Graphic	<G>	<GM>	<GP>							
System	<E>									
Modification	<RF>	<FW>	<FC>	<FT>	< (>					

[ESC+F] Sequential number

Hexadecimal code	ESC	F	Parameter
	<1B> ₁₆	<46> ₁₆	aaaabcccc(,dd,ee,f)
Initial value	Nil		

Valid range and term of command	When the power is OFF	The set parameter is not maintained.
	Valid range within items	The set parameter becomes invalid.
	Valid range between items	The set parameter becomes invalid.

[Function]

Specifying prior to the data specification command of font or barcode, and printing specified data in a sequential order.

[Format]

<F>aaaabcccc(,dd,ee,f)

- Parameter
 - a [Print quantity specification of identical contents] = Valid range : 1 to 9999
 - b [Increasing and decreasing specification]
 - + : Addition
 - : Subtraction
 - c [Setting of increasing and decreasing value] = Valid range : 1 to 9999
 - d [Valid digit number for sequential number] = Valid range : 1 to 99 When omitted: 8 (omissible)
 - e [Low-order invalid digit number] = Valid range : 0 to 99 When omitted: 0 (omissible)
 - f [Specification of Decimal/Hex sequential number]
 - 0 : Decimal number When omitted: 0 (omissible)
 - 1 : Hexadecimal

[Coding Example]

Print quantity specification of identical contents: 1, Increasing and decreasing specification: +, Setting of increasing and decreasing value: 1, Valid digit number for sequential number: 5, Low-order invalid digit number: 0

```
<A>
<V>100<H>100<P>2<L>0202
<F>1+1,5,0<XU>10000
<Q>2
<Z>
```

[Supplementary Explanation]

- Sequential number can be specified up to 8 points per format.
- Next print data from <F> command will be the initial value of sequential number.
- Specify the required number of digits for sequential number to print it properly.
- Specification of Black/White Reverse Print <> is not valid for sequential numbered data.
- Auto Linefeed <E> is not available.
- Need to print font or barcode to print sequential number.

- Digit number of sequential number should correspond to that of font/barcode data command. If the digit number of sequential number is larger, sequential number printing will not be performed.
- If the print data immediately after the sequential number command <F> becomes the sequential number invalid command, the sequential number will be invalid.

[Valid Commands]

Font	<XU>	<XS>	<XM>	<XB>	<XL>	<OA>	<OB>	<RD>	<\$=>	<U>
	<S>	<M>	<WB>	<WL>	<J>	<X20>	<X21>	<X22>	<X23>	<X24>
	<PP>									
Barcode		<BC>	<BG>	<BI>	<D>	<D><d>	<BD>	<BT>	<BW>	<BP>
	<BF>	<BS>	<BL>	<BL><d>	<BM>					
2D code	<2D50>	<2D51>								

[ESC+FW] Ruled / Grid Line Print

Hexadecimal code	ESC	FW	Parameter
	<1B> ₁₆	<46> ₁₆ <57> ₁₆	Rule aabccccc Grid aabbVccccHdddd
Initial value	Nil		

Valid range and term of command	When the power is OFF	The set parameter is not maintained.
	Valid range within items	The set parameter becomes invalid.
	Valid range between items	The set parameter becomes invalid.

[Function]

Specifying the ruled / grid line.

[Format]

<FW>aabccccc : Print of ruled line

- Parameter
 - a [Line width] = Valid range : 02 to 99 dots
 - b [Horizontal/vertical direction]
 - H : Horizontal direction
 - V : Vertical direction
 - c [Ruled line length] = Valid range : Refer to the table below.

<FW>aabbVccccHdddd : Print of grid line

- Parameter
 - a [Vertical line width] = Valid range : 02 to 99 dots
 - b [Horizontal line width] = Valid range : 02 to 99 dots
 - c [Vertical line length] = Valid range : Refer to the table below.
 - d [Horizontal line length] = Valid range : Refer to the table below.

[Coding Example 1]

Ruled line print, Line width: 4, Horizontal direction, Ruled line length: 400

Grid line print, Vertical line width: 8, Horizontal line width: 8, Vertical line length: 300, Horizontal line length: 400

```
<A>
<V>100<H>200<FW>04H400
<V>300<H>200<FW>0808V300H400
<Q>2
<Z>
```

[Supplementary Explanation]

- When the print start position exceeds the printing area, the printing is not performed. (This will not be a command error.)
- Set line width according to the table below so the horizontal line width is more than 0.166 mm.

Head density	Line width
203 dpi (8 dots/mm)	2 dots or more

- If setting the vertical line width wider, it will be widened to the right side against media feed direction. If setting the horizontal line width wider, it will be widened to the lower side against media feed direction.
- If setting the grid line wider, it will be widened inward.

[Valid Range]

Head density	Valid range: Horizontal (dots)	Valid range: Vertical (dots)
203 dpi	1 to 440	1 to 8000

[ESC+FC] Print Circle

Hexadecimal code	ESC	FC	Parameter
	<1B> ₁₆	<46> ₁₆ <43> ₁₆	,aaa,bbb(,c,d)
Initial value	Nil		

Valid range and term of command	When the power is OFF	The set parameter is not maintained.
	Valid range within items	The set parameter becomes invalid.
	Valid range between items	The set parameter becomes invalid.

[Function]

Specifying the print of circle.

[Format]

<FC>,aaa,bbb(,c,d)

- Parameter
 - a [Radius] = Valid range : 5 to 999 dots
 - b [Line width] = Valid range : 1 to 999 dots
 - c [Sectional number] = Valid range : 0 to 8 When omitted: 0 (omissible)
*See the details listed below.
 - d [Pattern] = Valid range : 0 to 3 When omitted: 0 (omissible)
 - 0 : Solid line (black)
 - 1 : Gray 1
 - 2 : Gray 2
 - 3 : Gray 3

- Sectional number

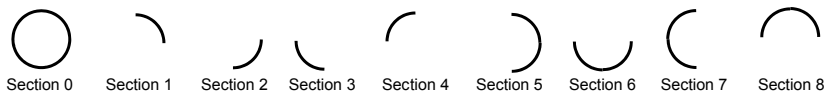

[Coding Example]

Solid line circle of 100 dots in radius, 8 dots in line width

```
<A>
<V>200<H>200
<FC>,100,8,0,0
<Q>1
<Z>
```

[Supplementary Explanation]

- When the value outside of the range is specified for sectional number, it will be processed as "0". (This will not be a command error.)
- When the value outside of the range is specified for the designation of pattern, it will be processed as "0". (This will not be a command error.)
- Even when the print start position exceeds the printing area, the printing is performed. (This will be a command error.)
- This command sets the base reference point to the center of a circle.

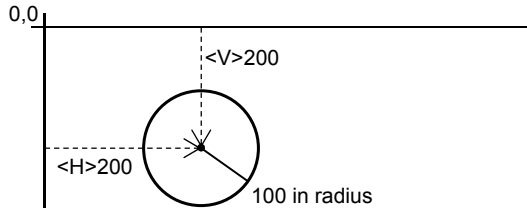

- This command can be registered to the format.
- If setting the grid line wider, it will be widened inward.

[Valid Range]

Valid range (dots)	
Radius	Line width
5 to 999	1 to 999

[ESC+FT] Print Triangle

Hexadecimal code	ESC	FT	Parameter
	<1B> ₁₆	<46> ₁₆ <54> ₁₆	,aaaa,bbbb(,cccc,d)
Initial value	Nil		

Valid range and term of command	When the power is OFF	The set parameter is not maintained.
	Valid range within items	The set parameter becomes invalid.
	Valid range between items	The set parameter becomes invalid.

[Function]

Specifying the print of triangle.

[Format]

<FT>,aaaa,bbbb(,cccc,d)

- Parameter
 - a [Length of sides] = Valid range : 10 to 2000 dots
 - b [Line width] = Valid range : 1 to 1000 dots
 - c [Length of base] = Valid range : 10 to 2000 dots (omissible)
When omitted, its value will be equal to the length of sides.
 - d [Pattern] = Valid range : 0 to 3 When omitted: 0 (omissible)
 - 0 : Solid line (black)
 - 1 : Gray 1
 - 2 : Gray 2
 - 3 : Gray 3

[Coding Example]

Length of sides: 100 dots, Line width: 8 dots, Length of base: 100 dots

```
<A>
<V>100<H>200
<FT>,100,8,100,0
<Q>1
<Z>
```

[Supplementary Explanation]

- When the value outside of the range is specified for pattern, it will be processed as "0". (This will not be a command error.)
- When the print start position exceeds the printing area, the printing is performed. (This will be a command error.)

(When the print start position exceeds the printing area in the vertical direction, the label will be fed.)

- When the side length is not equal to the base length, printing will not be performed due to command error.
- This command sets the base reference point to the apex of a triangle.

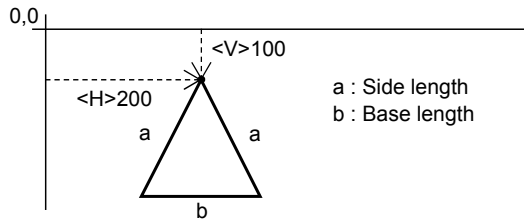

- This command can be registered to the format.
- If setting the line wider, it will be widened inward.
- If the base length is odd number, +1 will be added automatically to make even number.

[Valid number]

Valid range (dots)		
Side length	Line width	Base length
10 to 2000	1 to 1000	10 to 2000

[ESC+(] Reverse Color Print

Hexadecimal code	ESC	(Parameter
	<1B> ₁₆	<28> ₁₆	aaaa,bbbb
Initial value	Nil		

Valid range and term of command	When the power is OFF	The set parameter is not maintained.
	Valid range within items	The set parameter becomes invalid.
	Valid range between items	The set parameter becomes invalid.

[Function]

Specifying black and white reverse print.

[Format]

<(>aaaa,bbbb

- Parameter

- a [Specification of reverse area in horizontal direction] = Valid range: Refer to the table below
- b [Specification of reverse area in vertical direction] = Valid range: Refer to the table below

[Coding Example]

Reverse area in horizontal direction: 200, Reverse area in vertical direction: 70

```
<A>
<V>50<H>50<P>2<L>0202<XM>ABC
<V>50<H>50<( >200,70
<Q>2
<Z>
```

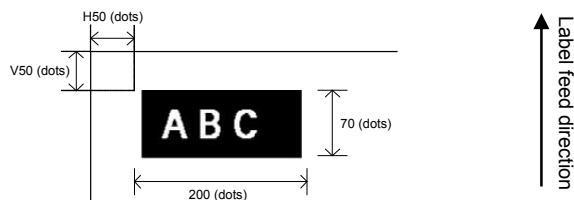

[Supplementary Explanation]

- Set this command next after the firm data string to be inverted. If it is set prior to the firm data the data will be printed in black without inverse.
- To set print start position, specify Horizontal Print Position <H> and Vertical Print Position <V> prior to this command.
- When the print start position exceeds the printing area, printing will not be performed due to command error.

[Note]

- For setting, keep the black print area under 30% of overall label.

[Valid Range]

Head density	Valid range: Area in horizontal direction (dots)	Valid range: Area in vertical direction (dots)
203 dpi	8 to 440	8 to 8000

[ESC+KC] Kanji Code

Hexadecimal code	ESC	KC	Parameter
	<1B> ₁₆	<4B> ₁₆ <43> ₁₆	a
Initial value	a=5 (GB18030 code)		

Valid range and term of command	When the power is OFF	The set parameter is not maintained.
	Valid range within items	The set parameter is valid until the next valid setting.
	Valid range between items	The set parameter becomes initial value at the next item <A>.

[Function]

This command allows temporary switch-over between Kanji codes. Normally it is specified by User mode of printer LCD settings.

[Format]

<KC>a

- Parameter

a [Kanji code]

- 0 : JIS code
- 1 : Shift JIS code
- 2 : Unicode (UTF-16)
- 3 : Unicode (UTF-8)
- 4 : BIG5 code
- 5 : GB18030 code
- 6 : KSC5601(EUC-KR) code

[Coding Example 1] For Kanji set (<KS>)=JISX208 Kanji, Shift JIS

```
<A>
<KS>1
<KC>1
<V>100<H>200<P>2<L>0202
<K1>H81698A94816A83548367815B
<Q>2
<Z>
```

[Coding Example 2] For Kanji set (<KS>)=JISX208 Kanji, JIS

```
<A>
<KS>1
<KC>0
<V>100<H>200<P>2<L>0202
<K1>H214A3374214B25352548213C
<Q>2
<Z>
```

[Coding Example 3] For Kanji set (<KS>)=JISX213 Kanji, Unicode (UTF-16)

```
<A>
<KS>2
<KC>2
<V>100<H>200<P>2<L>0202
<K1>HFF08682AFF0930B530C830FC
```

<Q>2

<Z>

[Supplementary Explanation]

- There is no necessity to specify this command in the normal label printing.
- To set Shift JIS as initial value, use User mode of printer LCD setting.
- It is possible to specify multiple Kanji codes within 1 item.
- Please use the appropriate Kanji code according to the Kanji set specified in Kanji set <KS>.
- When the Kanji set is changed, specify this command after Kanji set <KS>.

[Parameter valid range]

Kanji Set <KS>	Kanji Code <KC> valid range
Japanese JIS208 Kanji (JISX208)	0: JIS code 1: Shift JIS code 2: Unicode (UTF-16) 3: Unicode (UTF-8)
Japanese JIS213 Kanji (JISX213)	1: Shift JIS code 2: Unicode (UTF-16) 3: Unicode (UTF-8)
Chinese Simplified (GB18030)	3: Unicode (UTF-8) 5: GB18030 code
Chinese Traditional (BIG5)	3: Unicode (UTF-8) 4: BIG5 code
Korean (KSC5601)	3: Unicode (UTF-8) 6: KSC5601 (EUC-KR) code

[ESC+&] Store Form Overlay

Hexadecimal code	ESC	&	Parameter
	<1B> ₁₆	<26> ₁₆	(aab~b)
Initial value	Nil		

Valid range and term of command	When the power is OFF	The set command is not maintained.
	Valid range within item	The set parameter is valid until the next valid setting.
	Valid range between items	The set parameter is valid until the next valid setting.

[Function]

Specifying the registration of form overlay.

[Format]

<&>(aab~b)

- Parameter

a [Registration key] = Valid range : 01 to 99 (omissible)

b [Comment] = Max. 16 bytes (omissible)

[Coding Example]

```
<A>
<V>100<H>50<FW>1010V800H750
<V>100<H>50<FW>0505V760H710
<V>100<H>50<XB>0MODEL
<&>01DATA1
<Z>
```

[Supplementary Explanation]

- This command saves fixed print contents to the printer and then, Recall Form Overlay </> combines the contents with drawing of general data to print out.
- Specify this command at the end of data string that is to be stored. Drawing valid range in form overlay registration is same as printing area.
- This command can register only one format. Use any code from 01 to 99 as a registration key.
- To change contents, specify Clear Form Overlay <*>&, and then register new storage data.
- Invoke registered contents by Recall Form Overlay </>.
- When specifying Label Size <A1>, it will be extracted in the specified area.

[Valid Commands]

Print position	<V>	<H>								
Font	<XU>	<XS>	<XM>	<XB>	<XL>	<OA>	<OB>	<RD>	<\$=>	<K1>
	<K2>	<K3>	<K4>	<K5>	<K8>	<K9>	<KA>	<KB>	<KD>	<k1>
	<k2>	<k3>	<k4>	<k5>	<k8>	<k9>	<kA>	<kB>	<kD>	<U>
	<S>	<M>	<WB>	<WL>	<X20>	<X21>	<X22>	<X23>	<X24>	<PP>
Barcode		<BC>	<BG>	<BI>	<D>	<D><d>	<BD>	<BT>	<BW>	<BP>
	<BF>	<BS>	<BL>	<BL><d>	<BM>					
2D code	<2D10>	<BK>	<2D12>	<2D20>	<BV>	<2D30>	<2D31>	<2D32>	<BQ>	<2D50>
	<BX>	<2D51>	<2D70>							
Composite Symbol	<EU>									
Modification	<WD>	<FW>	<(>	<RF>	<RM>					
Graphic	<G>	<GM>	<GP>							

[ESC+/] Recall Form Overlay

Hexadecimal code	ESC	/	Parameter
	<1B> ₁₆	<2F> ₁₆	(aa)
Initial value	Nil		

Valid range and term of command	When the power is OFF	The set command is not maintained.
	Valid range within items	The set parameter is valid until the next valid setting.
	Valid range between items	The set parameter is valid until the next valid setting.

[Function]

Recalling form overlay.

[Format]

</>(aa)

- Parameter

a [Registration key] = Valid Range : 01 to 99 (omissible)

[Coding Example]

```
<A>
</>01
<V>200<H>100<P>0<S>B,100,100,6
<S>=>SATOPRINTER
<V>720<H>150<B>102100*95000012345*
<Q>2
<Z>
```

[Supplementary Explanation]

- This command invokes the contents registered by Store Form Overlay <&> to print.
- When detecting this command in normal print data, it will be combined with drawing stored in form overlay and printed.
- The registration key is not checked, so that specifying wrong registration key does not raise an error.

[ESC+0] Partial Edit

Hexadecimal code	ESC	0	Parameter
	<1B> ₁₆	<30> ₁₆	Nil
Initial value	Nil		

Valid range and term of command	When the power is OFF	The set command is not maintained.
	Valid range within items	The set command becomes invalid.
	Valid range between items	The set command becomes invalid.

[Function]

Editing the portion in the previous print data.

[Format]

<0>

[Coding Example]

[DEF], a part of print data, is changed to [123].

First label

```
<A>
<V>100<H>200<P>2<L>0202<XM>ABC
<V>100<H>200<P>2<L>0202<XM>DEF
<Q>1
<Z>
```

Second label

```
<A>
<0>
<V>100<H>200<P>2<L>0202<XM>123
<Q>1
<Z>
```

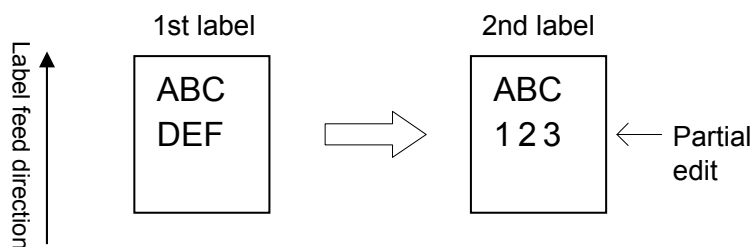

[Supplementary Explanation]

- Use this command to edit only one part of previous print data.
- Invoke the previous print data with this command to edit and print out. In this case, specify the part of previous data to edit, and send change data to it.
- Specified portion in the previous data will be cleared.
- If Rotation <%> is included in the specified editing portion, keep it for partial editing.
- Use this command with fixed pitch, same font or same digit number.

[ESC+WD] Partial Copy

Hexadecimal code	ESC	WD	Parameter
	<1B> ₁₆	<57> ₁₆ <44> ₁₆	VaaaaaHbbbbYccccXdddd
Initial value	Nil		

Valid range and term of command	When the power is OFF	The set parameter is not maintained.
	Valid range within items	The set command becomes invalid.
	Valid range between items	The set parameter becomes invalid.

[Function]

Copying specified area to another place.

[Format]

<WD>VaaaaaHbbbbYccccXdddd

- Parameter
 - a [Vertical start point of original data] = Valid range: Refer to the table below.
 - b [Horizontal start point of original data] = Valid range: Refer to the table below.
 - c [Vertical dot size of original data] = Valid range: Refer to the table below.
 - d [Horizontal dot size of original data] = Valid range: Refer to the table below.

[Coding Example]

Vertical start point of original data: 50, Horizontal start point of original data: 50,

Vertical dot size of original data: 200, Horizontal dot size of original data: 400

```
<A>
<V>50<H>50<P>2<L>0202<XU>ABCD
<V>300<H>100<WD>V50H50Y200X400
<Q>2
<Z>
```

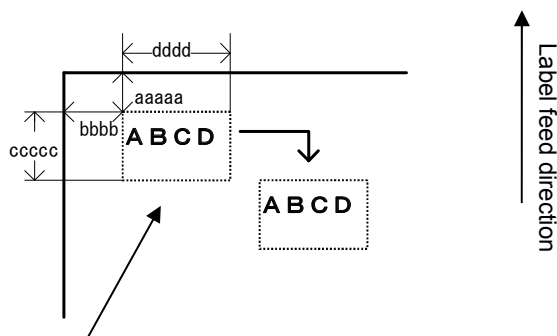

Dotted line part indicates the copied area.
Actual print portion is "ABCD".

[Supplementary Explanation]

- To locate the destination of copy, specify Vertical Print Position <V> and Horizontal Print Position <H> prior to this command.
- Destination of copy has to be outside of specified original data.

- When the print start position of the copied area is outside of printing area, printing will not be performed due to command error.

[Valid Range]

Head density	Valid range: Horizontal start point of original data	Valid range: Vertical start point of original data
	Horizontal dot size of original data (dots)	Vertical dot size of original data (dots)
203 dpi	1 to 440	1 to 8000

Even if the specified parameter is within a valid range, it may get out of the valid range depending on its print start position, base position of copy or dot size. In that case, command error will occur.

[ESC+J] Journal Print

Hexadecimal code	ESC	J	Parameter
	<1B> ₁₆	<4A> ₁₆	a...a+CR<0D> ₁₆
Initial value	Nil		

Valid range and term of command	When the power is OFF	The set parameter is not maintained.
	Valid range within items	The set parameter becomes invalid.
	Valid range between items	The set parameter becomes invalid.

[Function]

Specifying the print of journal.

[Format]

<J>a...a+CR

- Parameter

a [Journal print column] = Print data
CR [Control code (0DH)]

[Coding Example]

```
<A>
<J>
ABCD+CR
EFGH+CR
<Z>
```

[Supplementary Explanation]

- This command starts journal print from vertical position of 2 dots and horizontal position of 2 dots.
- Character pitch is set to 2 dots and line pitch is set to 16 dots.
- This command prints in 2 x 2 times of XS font.
- Use of this command in combination with other commands excluding Reprint <C> and Black and White Reverse Print <(> is invalid.
- This command performs the line feed regardless of setting of CR/LF deletion.

[ESC+RF] Recall Font & Logo

Hexadecimal code	ESC	RF	Parameter
	<1B> ₁₆	<52> ₁₆ <46> ₁₆	aabbbb,n...n
Initial value	aa=01, bbbb=1		

Valid range and term of command	When the power is OFF	The set parameter is not maintained.
	Valid range within items	The set parameter becomes invalid.
	Valid range between items	The set parameter becomes invalid.

[Function]

Invoking and printing the font and logo downloaded with exclusive tool.

[Format]

<RF>aabbbb,n...n

- Parameter
 - a [Font ID number] = Valid range: 01 to 99
 - b [Print digit] = Valid range: 1 to 9999
 - c [Print data] = data

[Coding Example 1]

To print [AB] in half size character with this command [Font ID No.: 01, Print digit: 4]

(Unicode[A: <0041>₁₆ B: <0042>₁₆)

```
<A>
<PS>
<V>100<H>100<L>0101
<RF>010004,<0041>16<0042>16
<Z>
```

[Coding Example 2]

When calling and printing logo [Font ID No.: 02 Print digit: 2]

```
<A>
<V>100<H>100<L>0101<RF>020002,<826B>16
<Z>
```

[Supplementary Explanation]

- Specify the value of print data putting Unicode(UTF-16BE).
- When calling and printing logo, specify [Print digit: 0002], [Print data: <826B>₁₆].
Note that <826B>₁₆ is the value of Shift JIS code of L.
- For [Print Data] parameter, the byte order changes depending on compatibility settings for Font/ Logo call.
 - Specify little endian when compatibility settings are enabled.
e.g.) Specify <4100> for character "A".
 - Specify big endian when compatibility settings are disabled.
e.g.) Specify <0041> for character "A".

[ESC+RM] Mirror Image

Hexadecimal code	ESC	RM	Parameter
	<1B> ₁₆	<52> ₁₆ <4D> ₁₆	aaaa,bbbb
Initial value	Nil		

Valid range and term of command	When the power is OFF	The set parameter is not maintained.
	Valid range within items	The set parameter becomes invalid.
	Valid range between items	The set parameter becomes invalid.

[Function]

Performing mirror rotation of print data.

[Format]

<RM>aaaa,bbbb

- Parameter
 - a [Horizontal range of mirror rotation specification] = Valid range: Refer to the table below.
 - b [Vertical range of mirror rotation specification] = Valid range: Refer to the table below.

[Coding Example 1]

When the range of mirror rotation is specified:

```
<A>
<H>100<V>200<XS>12345
<H>100<V>200<RM>0200,0080
<Q>1
<Z>
```

[Coding Example 2]

When the range of mirror rotation is not specified:

```
<A>
<H>100<V>200<XS>12345
<RM>
<Z>
```

[Supplementary Explanation]

- When the parameter "aaaa" and "bbbb" are not specified, all print data specified prior to this command will be rotated.
- Data outside of printing area will not rotate.
- If specifying this command for the item that does not contain print data, the command error will occur.
- This command cannot be used in combination with the commands that associated with reedition of print data. Refer to the invalid commands list below. When the command that cannot use in combination with is specified, print result is not guaranteed.
- This command cannot be used in combination with some registration commands. Refer to the invalid commands list below. When the command that cannot use in combination with is specified, print result is not guaranteed.
- This command cannot be used in combination with some of the modification commands. Refer to the invalid commands list below. When the command that cannot use in combination with is specified, print result is not guaranteed.
- This command prints the mirror image of the print data put before the mirror rotation command is specified. The data after the command does not rotate. Note that specifying this command several times results rotating the data several times.
- When the mirror image is applied for the barcode, reading of the barcode and the head damage check are not guaranteed.
- When executing the mirror image, the head damage check will be performed for all the areas where rotated.

[Valid Range for start position of mirroring]

Head density	Valid Range (dots)	
	Horizontal start position of mirror rotation specification	Vertical start position of mirror rotation specification
203 dpi	1 to 440	1 to 8000

[Valid Range for mirror rotation]

Head density	Valid Range (dots)	
	Horizontal range of mirror rotation	Vertical range of mirror rotation
203 dpi	8 to 440	8 to 8000

[Invalid Commands]

Command that associated with reediting.	<WD>	<F>	<(>	<0>	<WA>						
Registration	<GI>	<GT>	<PI>								
Modification	<%>										

[ESC+KS] Kanji Set

Hexadecimal code	ESC	KS	Parameter
	<1B> ₁₆	<4B> ₁₆ <53> ₁₆	a
Initial value	a=3		

Valid range and term of command	When the power is OFF	The set parameter is maintained.
	Valid range within items	The set parameter is in effect until a new specification is made.
	Valid range between items	The set parameter is in effect until a new specification is made.

[Function]

Setting the kanji set.

[Format]

<KS>a

- Parameter

a [Kanji Set] = Refer to the table blow.

[Coding Example]

Specifying GB18030

<A>

<KS>3

<Z>

[Supplementary Explanation]

- Select the kanji set to be printed by using <K1>16 x 16 dots horizontal writing kanji command, <K2>24 x 24 dots horizontal writing command, <k1>16 x 16 dots vertical writing kanji command and <k2>24 x 24 dots vertical dots command.
- An appropriate Kanji code should be specified when switching the Kanji Set. If the right code is not specified, the print may fail.

[Initial value for parameter and Valid range]

Initial value	Valid range
3	1: Japanese, JIS208 Kanji (JISX208) 2: Japanese, JIS213 Kanji (JISX213) 3: Chinese, Simplified Chinese characters (GB18030) 4: Reserved 5: Chinese, Traditional Chinese characters (BIG5) 6: Korean (KSX1001)

[ESC+AL] Field alignment

Hexadecimal code	ESC	AL	Parameter
	<1B> ₁₆	<41> ₁₆ <4C> ₁₆	a
Initial value	a=1		

Valid range and term of command	When the power is OFF	The set parameter is not maintained.
	Valid range within items	The set parameter is valid until the next valid setting.
	Valid range between items	The set parameter becomes initial value at the next item <A>.

[Function]

The base reference point specified with print positioning commands <H>, <V> is equal to the "Alignment position" of this command. The field's base reference points are changeable with "Alignment position". The supported fields are all text fields, barcode, 2D barcode, graphics, ruled lines and boxes etc.

[Format]

<AL>a

- Parameter
 - a Alignment position
 - 1: Top left
 - 2: Top center
 - 3: Top right
 - 4: Middle left
 - 5: Middle center
 - 6: Middle right
 - 7: Bottom left
 - 8: Bottom center
 - 9: Bottom right

[Field and alignment positions (for font command)]

The number inside the circle indicate the value of parameter a, "Alignment position (the positions specified with print positioning commands <H>, <V>".

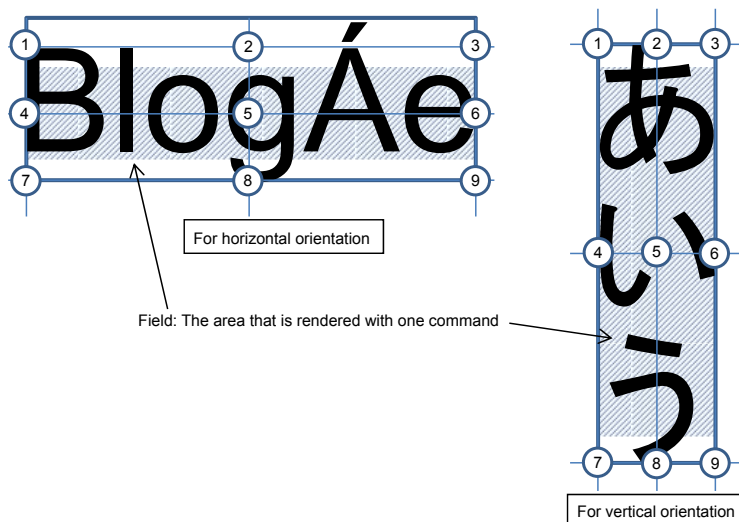

[Coding Example]

Font's alignment position: Top Right, barcode alignment position: Bottom left

```
<A>
<AL>3
<V>100<H>700<P>3<L>0403<X22>,ABCD
<AL>7
<V>400<H>200<BD>103160*123*
<Q>2
<Z>
```

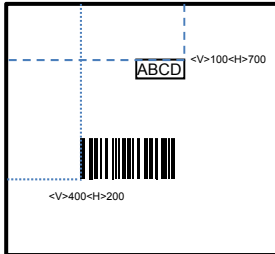

[Supplementary Explanation]

- The alignment position will ignore anything that was set, and sets the default "Top left" if the value for parameter a was 0 or a non-numeric value.
- If you select Middle or Bottom, the position may vary depending on the ascender line and descender line of each field. Ascender/descender lines depend on each font, so not all fonts may show like in the examples as below.

E.g.) Cases with and without 'í' and 'g'

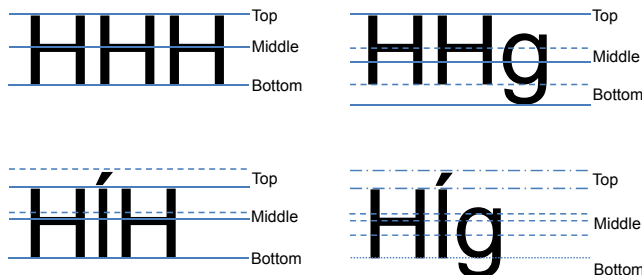

- Make sure to specify <H> and <V> to the field when you select Center and Right. If they are not specified when specifying for the 2nd field, the trailing edge of the 1st field becomes the base reference point of the 2nd field, which means that the parts of the 1st and 2nd field will overlap.

E.g.) If <H> and <V> are not specified to the 2nd field when specifying Center;

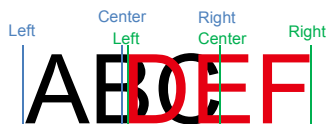

E.g.) If <H> and <V> are not specified to the 2nd field when specifying Right;



- Printer does not print if the positions specified with <H> and <V> (equal to "Alignment position") if they are out of printing area.

- There are cases where the rendered field may run off from printing area depending on "Alignment position" and print position commands <H> and <V>. Command error (Position Error) may occur depending on the conditions as described below.

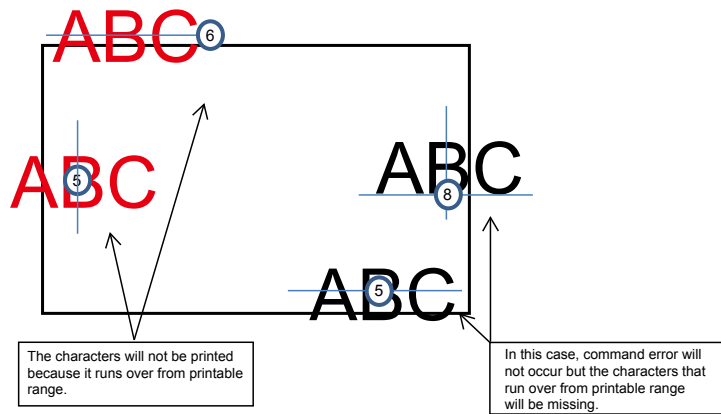

- The composition of the field depends on the command when specifying "Alignment position" for barcode and 2D code fields.

Ex.) When specifying barcode, 2D code without automatically attached human readables

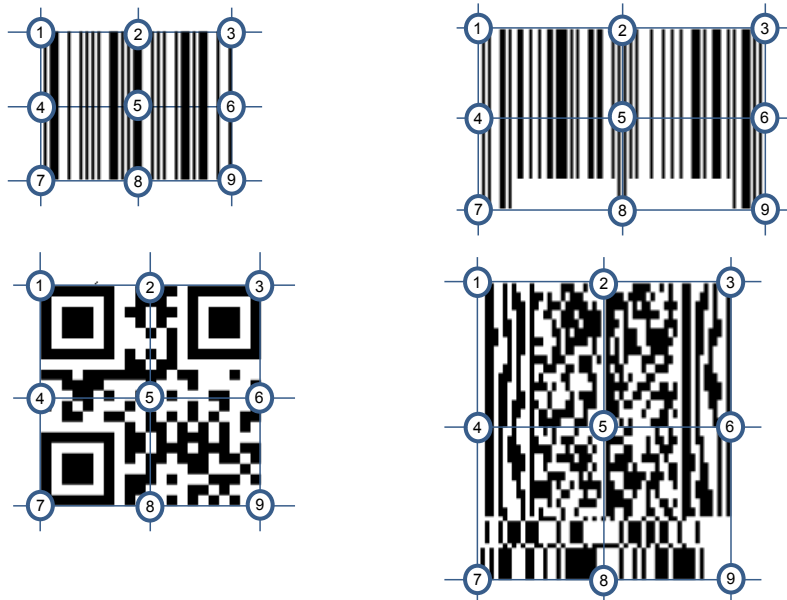

Ex.) When specifying a barcode with automatically attached human readables (<BD>, <BM> <BI> etc.)



- The left alignment position in the top, middle, and bottom differs for barcodes such as UPC-A and JAN/EAN-13 with <BD> / <BM> command since the human readable text is printed in the left of the barcode.



Note:

- Human readables are included in the field of "Field Alignment" for barcode.
- Printer works as below if the printing runs off printing area as a result of "Alignment position".
 - Position Error will occur and will not print if the top left of the barcode runs off.
 - International models will print if the Top Left of the barcode does not run off the paper. However some parts of the barcode will be missing.
 - Barcodes will be printed if human readables run off the Left of the paper. However the human readables will not be printed.

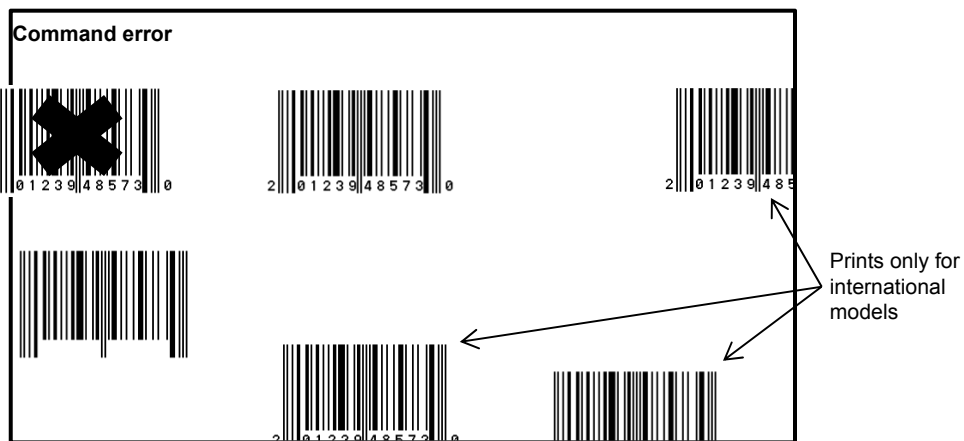

[Available commands]

Font	<XU>	<XS>	<XM>	<XB>	<XL>	<OA>	<OB>	<U>	<S>	<M>
	<WB>	<WL>	<X20>	<X21>	<X22>	<X23>	<X24>			
	<\$=>	<RD>	<RH>	<RG>						
	<K1>	<K2>	<K3>	<K4>	<K5>	<K8>	<K9>	<KA>	<KB>	<KD>
	<k1>	<k2>	<k3>	<k4>	<k5>	<k8>	<k9>	<kA>	<kB>	<kD>
	<K1> (<K2>)	<k1> (<k2>)	<PP>							
Barcode		<BC>	<BG>	<BI>	<D>	<D><d>*1	<BD>	<BW>	<BP>	<BM>
	<BF>*2	<BS>*3	<BL>	<BL><d>*1	<BZ>					
2D code	<2D10>	<2D12>	<2D20>	<2D30>	<2D31>	<2D32>	<2D50>	<2D51>	<2D33>	
	<BX>	<BK>	<BV>	<BQ>	<FX>					
Composite barcode	<EU>									
Graphics	<G>	<GM>	<GP>							
System	<E>									
Modification	<FW>	<F>	<%>	<RF>	<L>	<P>	<PS>	<PR>		

*1 The position depends on the specified human readable type and data. Make sure to specify just the right number of characters for human readable data. Printing is not guaranteed if there are excess or insufficient human readable.

*2 <BF>: Bookland is a barcode which uses multiple commands such as <BD> and <BF>, <D>~<d> and <BF>. Please arrange so that they are printed in expected positions since alignment positions are calculated by each field for this command.

*3 <BS>: USPS Barcode has the same position as specifying Middle position in this command without specifying this command. When you specify Middle position with this command, it prints to an alignment position equivalent to Bottom position.

Example) Top left

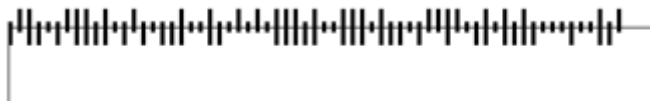

Example) Middle left



Example) Bottom left



Font command

[ESC+X20] X20 font (Basic size 5 x 9 dots)

Hexadecimal code	ESC	X20	Parameter
	<1B> ₁₆	<58> ₁₆ <32> ₁₆ <30> ₁₆	,n...n
Initial value	Nil		

Valid range and term of command	When the power is OFF	The set parameter is not maintained.
	Valid range within items	The set parameter becomes invalid.
	Valid range between items	The set parameter becomes invalid.

[Function]

Font with the basic size of: width 5 dots, height 9 dots is specified.

[Format]

<X20>,n...n

- Parameter

n [Print data] = Data

[Coding example]

```
<A>
<V>100<H>200<P>2<L>0304<X20>,ABCDE
<Q>2
<Z>
```

[Notes]

- The X20 font only allows the setting of a fixed pitch.

[Valid Commands]

Print position	<V>	<H>								
Modification	<P>	<L>	<%>	<F>	<&>	</>	<0>	<WD>		
Barcode	<D><d>	<BL><d>								

X20 font character set

Basic size is 5 x 9 dots (width x height)

X20 FONT(L0303) 203DP I

	2	3	4	5	6	7	8	9	A	B	C	D	E	F
0		ø	@	P		p				-	夕	ミ		
1	!	1	À	Q	a	q				ア	チ	ム		
2	"	2	B	R	b	r				イ	ツ	メ		
3	#	3	C	S	c	s				ウ	テ	モ		
4	\$	4	D	T	d	t				エ	ト	セ		
5	%	5	E	U	e	u			・	オ	ナ	ユ		
6	&	6	F	V	f	v			ヨ	カ	ニ	ヨ		
7	'	7	G	W	g	w				キ	ヌ	ラ		
8	<	8	H	X	h	x				ク	ネ	リ		
9	>	9	I	Y	i	y				ケ	ノ	ル		
A	*	:	J	Z	j	z				コ	ハ	シ		
B	+	;	K	ø	k	-				サ	ヒ	ロ		
C	,	<	L	¥	l	-				シ	フ	ワ		
D	-	=	M		m					ス	ヘ	ン		
E	.	>	N		n	!				セ	ホ	ハ		
F	/	?	O		o					ソ	マ	◇		

The print sample shown above is issued with a head density of 8 dots/mm and an enlargement ratio of 3 (vertical/horizontal).

The data from 00 (H) to 1F (H) are control codes and you cannot use them.

[ESC+X21] X21 font (Basic size 17 x 17 dots)

Hexadecimal code	ESC	X21	Parameter
	<1B> ₁₆	<58> ₁₆ <32> ₁₆ <31> ₁₆	,n...n
Initial value	Nil		

Valid range and term of command	When the power is OFF	The set parameter is not maintained.
	Valid range within items	The set parameter becomes invalid.
	Valid range between items	The set parameter becomes invalid.

[Function]

Font with the basic size of: width 17 dots, height 17 dots is specified.

[Format]

<X21>,n...n

- Parameter

n [Print data] = Data

[Coding example]

```
<A>
<V>100<H>200<P>2<L>0304<X21>,ABCDE
<Q>2
<Z>
```

[Supplementary Explanation]

- The X21 font allows the setting of a fixed pitch or the setting of a proportional pitch.
- Font pitch (fixed/proportional) can be selected via command or "Settings Mode" of this product.

[Valid Commands]

Print position	<V>	<H>								
Modification	<P>	<L>	<%>	<PS>	<PR>	<F>	<&>	</>	<0>	<WD>
Barcode	<D><d>	<BL><d>								

X21 font character set

Basic size is 17 x 17 dots (width x height)

X21 FONT(L0202) 203DPI

	2	3	4	5	6	7	8	9	A	B	C	D	E	F
0		0	@	P	'	p				一	タ	ミ		
1	!	1	A	Q	a	q			。	ア	チ	ム		
2	"	2	B	R	b	r			「	イ	ツ	メ		
3	#	3	C	S	c	s			」	ウ	テ	モ		
4	\$	4	D	T	d	t			、	エ	ト	ヤ		
5	%	5	E	U	e	u			・	オ	ナ	ユ		
6	&	6	F	V	f	v			ヲ	カ	ニ	ヨ		
7	'	7	G	W	g	w			ア	キ	ヌ	ラ		
8	(8	H	X	h	x			イ	ク	ネ	リ		
9)	9	I	Y	i	y			ウ	ケ	ノ	ル		
A	*	:	J	Z	j	z			エ	コ	ハ	レ		
B	+	;	K	[k	{			オ	サ	ヒ	ロ		
C	,	<	L	¥	l	!			ヤ	シ	フ	ワ		
D	-	=	M]	m	}			ユ	ス	ヘ	ソ		
E	.	>	N	^	n	~			ヨ	セ	ホ	ゝ		
F	/	?	0	_	o				ツ	ソ	マ	。		

The print sample shown above is issued with a head density of 8 dots/mm and an enlargement ratio of 2 (vertical/horizontal).

The data from 00 (H) to 1F (H) are control codes and you cannot use them.

[ESC+X22] X22 font (Basic size 24 x 24 dots)

Hexadecimal code	ESC	X22	Parameter
	<1B> ₁₆	<58> ₁₆ <32> ₁₆ <32> ₁₆	,n...n
Initial value	Nil		

Valid range and term of command	When the power is OFF	The set parameter is not maintained.
	Valid range within items	The set parameter becomes invalid.
	Valid range between items	The set parameter becomes invalid.

[Function]

Font with the basic size of: width 24 dots, height 24 dots is specified.

[Format]

<X22>,n...n

- Parameter

n [Print data] = Data

[Coding example]

```
<A>
<V>100<H>200<P>2<L>0304<X22>,ABCDE
<Q>2
<Z>
```

[Supplementary Explanation]

- The X22 font allows the setting of a fixed pitch or the setting of a proportional pitch.
- Font pitch (fixed/proportional) can be selected via command or "Settings Mode" of this product.

[Valid Commands]

Print position	<V>	<H>								
Modification	<P>	<L>	<%>	<PS>	<PR>	<F>	<&>	</>	<0>	<WD>
Barcode	<D><d>	<BL><d>								

X22 font character set

Basic size is 24 x 24 dots (width x height)

X22 FONT(L0202) 203DPI

	2	3	4	5	6	7	8	9	A	B	C	D	E	F
0		0	@	P	`	p				一	タ	ミ		
1	!	1	A	Q	a	q			。	ア	チ	ム		
2	”	2	B	R	b	r			「	イ	ツ	メ		
3	#	3	C	S	c	s			」	ウ	テ	モ		
4	\$	4	D	T	d	t			、	エ	ト	ヤ		
5	%	5	E	U	e	u			・	オ	ナ	ユ		
6	&	6	F	V	f	v			ヲ	カ	ニ	ヨ		
7	’	7	G	W	g	w			ア	キ	ヌ	ラ		
8	(8	H	X	h	x			イ	ク	ネ	リ		
9)	9	I	Y	i	y			ウ	ケ	ノ	ル		
A	*	:	J	Z	j	z			エ	コ	ハ	レ		
B	+	;	K	[k	{			オ	サ	ヒ	ロ		
C	,	<	L	¥	l	!			ャ	ッ	フ	ワ		
D	—	=	M]	m	}			ユ	ス	ヘ	ン		
E	.	>	N	^	n	~			ヨ	セ	ホ	°		
F	/	?	O	_	o				ッ	ソ	マ	°		

The print sample shown above is issued with a head density of 8 dots/mm and an enlargement ratio of 2 (vertical/horizontal).

The data from 00 (H) to 1F (H) are control codes and you cannot use them.

[ESC+X23] X23 font (Basic size 48 x 48 dots)

Hexadecimal code	ESC	X23	Parameter
	<1B> ₁₆	<58> ₁₆ <32> ₁₆ <33> ₁₆	,an...n
Initial value	Nil		

Valid range and term of command	When the power is OFF	The set parameter is not maintained.
	Valid range within items	The set parameter becomes invalid.
	Valid range between items	The set parameter becomes invalid.

[Function]

Font with the basic size of: width 48 dots, height 48 dots is specified.

[Format]

<X23>,an...n

- Parameter
 - a [Smoothing]
 - 0 : Smoothing disabled
 - 1 : Smoothing ON (Only available if expansion factor is between 3 and 12))
 - n [Print data] = Data

[Coding example]

```
<A>
<V>100<H>200<P>2<L>0304<X23>,0ABCDE
<Q>2
<Z>
```

[Supplementary Explanation]

- The X23 font allows the setting of a fixed pitch or the setting of a proportional pitch.
- Font pitch (fixed/proportional) can be selected via command or "Settings Mode" of this product.
- When the smoothing is enabled, and the expansion <L> command is set to 1 or 2 or from 13 to 36, the smoothing function will be ignored.

[Valid Commands]

Print position	<V>	<H>								
Modification	<P>	<L>	<%>	<PS>	<PR>	<F>	<&>	</>	<0>	<WD>
Barcode	<D><d>	<BL><d>								

X23 font character set

Basic size is 48 x 48 dots (width x height)

X23 FONT(L0101) 203DPI

	2	3	4	5	6	7	8	9	A	B	C	D	E	F
0		0	@	P	`	p				一	タ	ミ		
1	!	1	A	Q	a	q			。	ア	チ	ム		
2	"	2	B	R	b	r			「	イ	ツ	メ		
3	#	3	C	S	c	s			」	ウ	テ	モ		
4	\$	4	D	T	d	t			、	エ	ト	ヤ		
5	%	5	E	U	e	u			・	オ	ナ	ユ		
6	&	6	F	V	f	v			ヲ	カ	ニ	ヨ		
7	'	7	G	W	g	w			ァ	キ	ヌ	ラ		
8	(8	H	X	h	x			ィ	ク	ネ	リ		
9)	9	I	Y	i	y			ウ	ケ	ノ	ル		
A	*	:	J	Z	j	z			ェ	コ	ハ	レ		
B	+	;	K	[k	{			ォ	サ	ヒ	ロ		
C	,	<	L	¥	l	!			ャ	シ	フ	ワ		
D	—	=	M]	m	}			ュ	ス	ヘ	ン		
E	.	>	N	^	n	~			ョ	セ	ホ	ゞ		
F	/	?	O	_	o				ッ	ソ	マ	°		

The print sample shown above is issued with a head density of 8 dots/mm and an enlargement ratio of 1 (vertical/horizontal).

The data from 00 (H) to 1F (H) are control codes and you cannot use them.

[ESC+X24] X24 font (Basic size 48 x 48 dots)

Hexadecimal code	ESC	X24	Parameter
	<1B> ₁₆	<58> ₁₆ <32> ₁₆ <34> ₁₆	,an...n
Initial value	Nil		

Valid range and term of command	When the power is OFF	The set parameter is not maintained.
	Valid range within items	The set parameter becomes invalid.
	Valid range between items	The set parameter becomes invalid.

[Function]

Font with the basic size of: width 48 dots, height 48 dots is specified.

[Format]

<X24>,an...n

- Parameter
 - a [Smoothing]
 - 0 : Smoothing OFF
 - 1 : Smoothing ON (Only available if expansion factor is between 3 and 12)
 - n [Print data] = Data

[Coding example]

```
<A>
<V>100<H>200<P>2<L>0304<X24>,0ABCDE
<Q>2
<Z>
```

[Supplementary Explanation]

- The X24 font allows the setting of a fixed pitch or the setting of a proportional pitch.
- Font pitch (fixed/proportional) can be selected via command or "Settings Mode" of this product.
- When the smoothing is enabled, and the expansion <L> command is set to 1 or 2 or from 13 to 36, the smoothing function will be ignored.

[Valid Commands]

Print position	<V>	<H>								
Modification	<P>	<L>	<%>	<PS>	<PR>	<F>	<&>	</>	<0>	<WD>
Barcode	<D><d>	<BL><d>								

X24 font character set

Basic size is 48 x 48 dots (width x height)

X24 FONT(L0101) 203DPI

	2	3	4	5	6	7	8	9	A	B	C	D	E	F
0		0	@	P	'	p				一	タ	ミ		
1	!	1	A	Q	a	q			。	ア	チ	ム		
2	"	2	B	R	b	r			「	イ	ツ	メ		
3	#	3	C	S	c	s			」	ウ	テ	モ		
4	\$	4	D	T	d	t			、	エ	ト	ヤ		
5	%	5	E	U	e	u			・	オ	ナ	ユ		
6	&	6	F	V	f	v			ヲ	カ	ニ	ヨ		
7	'	7	G	W	g	w			ア	キ	ヌ	ラ		
8	(8	H	X	h	x			イ	ク	ネ	リ		
9)	9	I	Y	i	y			ウ	ケ	ノ	ル		
A	*	:	J	Z	j	z			エ	コ	ハ	レ		
B	+	;	K	[k	{			オ	サ	ヒ	ロ		
C	,	<	L	¥	l	!			ヤ	シ	フ	フ		
D	-	=	M]	m	}			ユ	ス	ヘ	ン		
E	.	>	N	^	n	~			ヨ	セ	ホ	°		
F	/	?	O	_	o				ツ	ソ	マ	°		

The print sample shown above is issued with a head density of 8 dots/mm and an enlargement ratio of 1 (vertical/horizontal).

The data from 00 (H) to 1F (H) are control codes and you cannot use them.

[ESC+XU] XU font (Basic size 5 x 9 dots)

Hexadecimal code	ESC	XU	Parameter
	<1B> ₁₆	<58> ₁₆ <55> ₁₆	n...n
Initial value	Nil		

Valid range and term of command	When the power is OFF	The set parameter is not maintained.
	Valid range within items	The set parameter becomes invalid.
	Valid range between items	The set parameter becomes invalid.

[Function]

Font with the basic size of: width 5 dots, height 9 dots is specified.

[Format]

<XU>n...n

- Parameter

n [Print data] = Data

[Coding example]

```
<A>
<V>100<H>200<P>2<L>0304<XU>ABCDE
<Q>2
<Z>
```

[Supplementary Explanation]

- The XU font allows the setting of a fixed pitch or the setting of a proportional pitch.
- Font pitch (fixed/proportional) can be selected via command or "Settings Mode" of this product.
- The character set varies according to setting of <CE> command.

[Valid Commands]

Print position	<V>	<H>								
Modification	<P>	<L>	<%>	<PS>	<PR>	<F>	<&>	</>	<0>	<WD>
Barcode	<D><d>	<BL><d>								

XU font character set

Basic size is 5 x 9 dots (width x height)

XU FONT(L0303) 203DPI

	2	3	4	5	6	7	8	9	A	B	C	D	E	F
0		ø	ø	P	`	p	ç	é	á	ø		ø	ó	-
1	!	1	A	Q	a	q	ü	æ	í			ð	β	±
2	"	2	B	R	b	r	é	Æ	ó			É	ô	=
3	#	3	C	S	c	s	á	ó	ú			Ë	ò	¼
4	\$	4	D	T	d	t	ä	ö	ñ			È	ø	¶
5	¥	5	E	U	e	u	à	ò	Ñ	Á		€	ø	§
6	&	6	F	V	f	v	à	û	æ	â	ã	í	µ	÷
7	'	7	G	W	g	w	ç	ù	ø	à	ã	î	þ	,
8	<	8	H	X	h	x	é	ÿ	¿	ø		ï	þ	°
9	>	9	I	Y	i	y	ë	ö	®				ú	¨
A	*	:	J	Z	j	z	è	ü	¬				û	+
B	+	;	K	[k	{	ï	ø	¼				ù	
C	,	<	L	\	l	!	î	£	¼				ý	³
D	-	=	M]	m	}	ì	ø	;	ø		;	ÿ	²
E	.	>	N	^	n	~	Ä	×	«	¥		;	~	
F	/	?	O	_	o	⌘	Ä	f	»		⌘		'	

The print sample shown above is issued with width 5 x height 9, enlargement ratio of 3 (vertical/horizontal) and DOS 858.

The data from 00 (H) to 1F (H) are control codes and you cannot use them.

[ESC+XS] XS font (Basic size 17 x 17 dots)

Hexadecimal code	ESC	XS	Parameter
	<1B> ₁₆	<58> ₁₆ <53> ₁₆	n...n
Initial value	Nil		

Valid range and term of command	When the power is OFF	The set parameter is not maintained.
	Valid range within items	The set parameter becomes invalid.
	Valid range between items	The set parameter becomes invalid.

[Function]

Font with the basic size of: width 17 dots, height 17 dots is specified.

[Format]

<XS>n...n

- Parameter

n [Print data] = Data

[Coding example]

```
<A>
<V>100<H>200<P>2<L>0304<XS>ABCDE
<Q>2
<Z>
```

[Supplementary Explanation]

- The XS font allows the setting of a fixed pitch or the setting of a proportional pitch.
- Font pitch (fixed/proportional) can be selected via command or "Settings Mode" of this product.
- The character set varies according to setting of <CE> command.

[Valid Commands]

Print position	<V>	<H>								
Modification	<P>	<L>	<%>	<PS>	<PR>	<F>	<&>	</>	<0>	<WD>
Barcode	<D><d>	<BL><d>								

XS font character set

Basic size is 17 x 17 dots (width x height)

XS FONT(L0202) 203DPI

	2	3	4	5	6	7	8	9	A	B	C	D	E	F
0		ø	@	P	'	p	Ç	É	á	ø		ð	ó	-
1	!	1	A	Q	a	q	ü	æ	í			Ð	ß	±
2	”	2	B	R	b	r	é	Æ	ó			È	Ò	=
3	#	3	C	S	c	s	â	ô	ú			Ê	Ô	¾
4	\$	4	D	T	d	t	ä	ö	ñ			Ë	Ö	¶
5	%	5	E	U	e	u	à	ò	Ñ	À		€	Ø	§
6	&	6	F	V	f	v	â	û	ä	Â	ã	í	µ	÷
7	'	7	G	W	g	w	ç	ù	ó	À	Ã	î	þ	,
8	(8	H	X	h	x	ê	ÿ	¿	©		ÿ	þ	°
9)	9	I	Y	i	y	ë	ö	®				ú	”
A	*	:	J	Z	j	z	è	ü	¬				ó	•
B	+	;	K	[k	{	ï	ø	½				ù	1
C	,	<	L	\	l	!	î	£	¼				ý	3
D	-	=	M]	m	}	ì	ø	ì	€		:	ÿ	2
E	.	>	N	^	n	~	Ä	×	«	¥		ì	˘	
F	/	?	O	_	o	■	Å	f	»		α		˘	

The print sample shown above is issued with width 17 x height 17, enlargement ratio of 2 (vertical/horizontal) and DOS 858.

The data from 00 (H) to 1F (H) are control codes and you cannot use them.

[ESC+XM] XM font (Basic size 24 x 24 dots)

Hexadecimal code	ESC	XM	Parameter
	<1B> ₁₆	<58> ₁₆ <4D> ₁₆	n...n
Initial value	Nil		

Valid range and term of command	When the power is OFF	The set parameter is not maintained.
	Valid range within items	The set parameter becomes invalid.
	Valid range between items	The set parameter becomes invalid.

[Function]

Font with the basic size of: width 24 dots, height 24 dots is specified.

[Format]

<XM>n...n

- Parameter

n [Print data] = Data

[Coding example]

```
<A>
<V>100<H>200<P>2<L>0304<XM>ABCDE
<Q>2
<Z>
```

[Supplementary Explanation]

- The XM font allows the setting of a fixed pitch or the setting of a proportional pitch.
- Font pitch (fixed/proportional) can be selected via command or "Settings Mode" of this product.
- The character set varies according to setting of <CE> command.

[Valid Commands]

Print position	<V>	<H>								
Modification	<P>	<L>	<%>	<PS>	<PR>	<F>	<&>	</>	<0>	<WD>
Barcode	<D><d>	<BL><d>								

XM font character set

Basic size is 24 x 24 dots (width x height)

XM FONT(L0202) 203DPI

	2	3	4	5	6	7	8	9	A	B	C	D	E	F
0		0	@P	`	p	Ç	É	á	Ø			ð	Ó	-
1	!	1	A Q	a q	ü	æ	í					Ð	β	±
2	”	2	B R	b r	é	Æ	ó					Ê	Ô	=
3	#	3	C S	c s	â	ô	ú					Ë	Ò	¾
4	\$	4	D T	d t	ä	ö	ñ					È	õ	¶
5	%	5	E U	e u	à	ò	Ñ	Á				€	Ö	§
6	&	6	F V	f v	ã	û	ä	Â	ã	í	μ	÷		
7	’	7	G W	g w	ç	ù	º	À	Ã	î	þ	,		
8	(8	H X	h x	ê	ÿ	¿	©				ï	þ	°
9)	9	I Y	i y	ë	ö	®					ú	”	
A	*	:	J Z	j z	è	ü	¬					û	•	
B	+	;	K [k {	ï	ø	½					ü	¹	
C	,	<	L \	l !	î	£	¼					ý	³	
D	-	=	M]	m }	ì	ø	ï	¢				ÿ	²	
E	.	>	N ^	n ~	Ä	x	<<	¥				ÿ	´	
F	/	?	O _	o	■	Ä	f	>>			œ	´		

The print sample shown above is issued with width 24 x height 24, enlargement ratio of 2 (vertical/horizontal) and DOS 858.

The data from 00 (H) to 1F (H) are control codes and you cannot use them.

[ESC+XB] XB font (Basic size 48 x 48 dots)

Hexadecimal code	ESC	XB	Parameter
	<1B> ₁₆	<58> ₁₆ <42> ₁₆	an...n
Initial value	a=0		

Valid range and term of command	When the power is OFF	The set parameter is not maintained.
	Valid range within items	The set parameter becomes invalid.
	Valid range between items	The set parameter becomes invalid.

[Function]

Font with the basic size of: width 48 dots, height 48 dots is specified.

[Format]

<XB>an...n

- Parameter

a [Smoothing]

0: Smoothing OFF

1: Smoothing ON (Valid for expansion factors <L> between 3 and 9)

n [Print data] = Data

[Coding example]

<A>

<V>100<H>200<P>2<L>0304<XB>0ABCDE

<Q>2

<Z>

[Supplementary Explanation]

- XB font allows the setting of a fixed pitch or the setting of a proportional pitch.
- Font pitch (fixed/proportional) can be selected via command or "Settings Mode" of this product.
- When the smoothing is enabled, and the expansion <L> command is set to 1 or 2 or from 10 to 36, the smoothing function will be ignored.
- The character set varies according to setting of <CE> command.

[Valid Commands]

Print position	<V>	<H>								
Modification	<P>	<L>	<%>	<PS>	<PR>	<F>	<&>	</>	<0>	<WD>
Barcode	<D><d>	<BL><d>								

XB font character set

Basic size is 48 x 48 dots (width x height)

XB FONT(L0101) 203DPI

	2	3	4	5	6	7	8	9	A	B	C	D	E	F
0	0	@	P	`	p	Ç	É	á	Ø		Š	Ó	–	
1	!	1	A	Q	a	q	ü	æ	í			Đ	β	±
2	”	2	B	R	b	r	é	Æ	ó			Ê	Ô	≡
3	#	3	C	S	c	s	â	ô	ú			È	Ò	¾
4	\$	4	D	T	d	t	ä	ö	ñ			È	õ	¶
5	%	5	E	U	e	u	à	ò	Ñ	Á		€	Õ	§
6	&	6	F	V	f	v	å	û	à	Â	ã	í	μ	÷
7	'	7	G	W	g	w	ç	ù	º	À	Ã	î	þ	,
8	(8	H	X	h	x	ê	ÿ	¿	©		ï	þ	°
9)	9	I	Y	i	y	ë	ö	®				Ú	..
A	*	:	J	Z	j	z	è	Ü	¬				Û	•
B	+	;	K	[k	{	ï	ø	½				Ü	1
C	,	<	L	\	l	!	î	£	¼				Ý	3
D	–	=	M]	m	}	ì	ø	¡	¢		!	Ý	2
E	.	>	N	^	n	~	Ä	×	«	¥		ì	–	
F	/	?	O	_	o	■	Å	f	»		α		´	

The print sample shown above is issued with width 48 x height 48, enlargement ratio of 1 (vertical/horizontal) and DOS 858.

The data from 00 (H) to 1F (H) are control codes and you cannot use them.

[ESC+XL] XL font (Basic size 48 x 48 dots)

Hexadecimal code	ESC	XB	Parameter
	<1B> ₁₆	<58> ₁₆ <4C> ₁₆	an...n
Initial value	Nil		

Valid range and term of command	When the power is OFF	The set parameter is not maintained.
	Valid range within items	The set parameter becomes invalid.
	Valid range between items	The set parameter becomes invalid.

[Function]

Font with the basic size of: width 48 dots, height 48 dots is specified.

[Format]

<XL>an...n

- Parameter
 - a [Smoothing]
 - 0: Smoothing OFF
 - 1: Smoothing ON (Valid for expansion factors <L> between 3 and 9)
 - n [Print data] = Data

[Coding example]

```
<A>
<V>100<H>200<P>2<L>0304<XL>0ABCDE
<Q>2
<Z>
```

[Supplementary Explanation]

- XL font allows the setting of a fixed pitch or the setting of a proportional pitch.
- Font pitch (fixed/proportional) can be selected via command or "Settings Mode" of this product.
- When the smoothing is enabled, and the expansion <L> command is set to 1 or 2 or from 10 to 36, the smoothing function will be ignored.
- The character set varies according to setting of <CE> command.

[Valid Commands]

Print position	<V>	<H>								
Modification	<P>	<L>	<%>	<PS>	<PR>	<F>	<&>	</>	<0>	<WD>
Barcode	<D><d>	<BL><d>								

XL font character set

Basic size is 48 x 48 dots (width x height)

XL FONT(L0101) 203DPI

	2	3	4	5	6	7	8	9	A	B	C	D	E	F
0	0	@	P	'	p	Ç	É	á	Ø		š	Ó	-	
1	!	1	A	Q	a	q	ü	æ	í			Ð	β	±
2	"	2	B	R	b	r	é	Æ	ó			Ê	Ô	=
3	#	3	C	S	c	s	â	ô	ú			Ë	Ò	¾
4	\$	4	D	T	d	t	ä	ö	ñ			È	õ	¶
5	%	5	E	U	e	u	à	ò	Ñ	Á		€	Õ	§
6	&	6	F	V	f	v	å	û	ª	Â	ã	Í	μ	÷
7	'	7	G	W	g	w	ç	ù	º	À	Ã	Î	þ	,
8	(8	H	X	h	x	ê	ÿ	¿	©		Ï	ƒ	°
9)	9	I	Y	i	y	ë	Ö	®			¼	Ú	••
A	*	:	J	Z	j	z	è	Ü	¬			½	Û	•
B	+	;	K	[k	{	ï	φ	½			¾	Ü	¹
C	,	<	L	\	l	!	î	£	¼			¾	Ý	³
D	-	=	M]	m	}	ì	Ø	¡	¢		¾	Ý	²
E	.	>	N	^	n	~	Ä	x	«	¥		¾	ì	-
F	/	?	O	_	o	■	Å	f	»		α	¾	ì	'

The print sample shown above is issued with width 48 x height 48, enlargement ratio of 1 (vertical/horizontal) and DOS 858.

The data from 00 (H) to 1F (H) are control codes and you cannot use them.

[ESC+OA] OCR-A font

Hexadecimal code	ESC	OA	Parameter
	<1B> ₁₆	<4F> ₁₆ <41> ₁₆	n...n
Initial value	Nil		

Valid range and term of command	When the power is OFF	The set parameter is not maintained.
	Valid range within items	The set parameter becomes invalid.
	Valid range between items	The set parameter becomes invalid.

[Function]

Specifying OCR-A font.

[Format]

<OA>n...n

- Parameter

n [Print data] = Data

[Coding example]

```
<A>
<V>100<H>100<P>2<L>0202<OA>ABC
<Q>2
<Z>
```

[Supplementary Explanation]

- Refer to the table below for font size of each head density.

[Font size table]

Head density	Font size (dots)
203 dpi (8 dots/mm)	W15 x H22

[Valid Commands]

Print position	<V>	<H>								
Modification	<P>	<L>	<%>	<F>	<&>	</>	<0>	<WD>		
Barcode	<D><d>	<BL><d>								

OCR-A font character set

OCR-A font specification.

◊A FONT L0202 203DPI

	2	3	4	5	6	7	8	9	A	B	C	D	E	F
0		0		P										
1		1	A	Q										
2		2	B	R										
3		3	C	S										
4	4	4	D	T										
5		5	E	U										
6		6	F	V										
7		7	G	W										
8		8	H	X										
9		9	I	Y										
A			J	Z										
B			K											
C			L											
D			M											
E	.	>	N											
F	/		◊											

The print sample shown above is issued with a head density of 8 dots/mm, a font size of 15 x 22, and an enlargement ratio of 2 (vertical/horizontal).

The data from 00 (H) to 1F (H) are control codes and you cannot use them.

[ESC+OB] OCR-B font

Hexadecimal code	ESC	OB	Parameter
	<1B> ₁₆	<4F> ₁₆ <42> ₁₆	n...n
Initial value	Nil		

Valid range and term of command	When the power is OFF	The set parameter is not maintained.
	Valid range within items	The set parameter becomes invalid.
	Valid range between items	The set parameter becomes invalid.

[Function]

Specifying OCR-B font.

[Format]

<OB>n...n

- Parameter

n [Print data] = Data

[Coding Example]

```
<A>
<V>100<H>100<P>2<L>0202<OB>ABC
<Q>2
<Z>
```

[Supplementary Explanation]

- Refer to the table below for font size of each head density.

[Font Size]

Head density	Font seize(dots)
203 dpi (8 dots/mm)	W20 x H24

[Valid Commands]

Print position	<V>	<H>								
Modification	<P>	<L>	<%>	<F>	<&>	</>	<0>	<WD>		
Barcode	<D><d>	<BL><d>								

OCR-B Font Character Set

OCR-B font specification.

OB FONT(L0202) 203DPI

	2	3	4	5	6	7	8	9	A	B	C	D	E	F
0		0	@	P										
1	!	1	A	Q										
2	"	2	B	R										
3	#	3	C	S										
4	\$	4	D	T										
5	%	5	E	U										
6	&	6	F	V										
7	'	7	G	W										
8	(8	H	X										
9)	9	I	Y										
A	*	:	J	Z										
B	+	;	K	¥										
C	,	<	L	Ÿ										
D	-	=	M											
E	.	>	N											
F	/	?	O											

The print sample shown above is issued with a head density of 8 dots/mm, a font size of 20 x 24, and an enlargement ratio of 2 (vertical/horizontal).

The data from 00 (H) to 1F (H) are control codes and you cannot use them.

[ESC+U] U Font (Basic size 5 x 9 dots)

Hexadecimal code	ESC	U	Parameter
	<1B> ₁₆	<55> ₁₆	n...n
Initial value	Nil		

Valid range and term of command	When the power is OFF	The set parameter is not maintained.
	Valid range within items	The set parameter becomes invalid.
	Valid range between items	The set parameter becomes invalid.

[Function]

Font with the basic size of: width 5 dots, height 9 dots is specified.

[Format]

<U>n...n

- Parameter

n [Print data] = Data

[Coding Example]

```
<A>
<V>100<H>200<P>2<L>0304<U>ABCDE
<Q>2
<Z>
```

[Supplementary Explanation]

- The U font only allows the setting of a fixed pitch.
- The character set varies according to setting of <CE> command.

[Valid Commands]

Print position	<V>	<H>								
Modification	<P>	<L>	<%>	<F>	<&>	</>	<0>	<WD>		
Barcode	<D><d>	<BL><d>								

U font character set

Basic size is 5 x 9 dots (width x height)

U FONT(L0303) 203DPI

	2	3	4	5	6	7	8	9	A	B	C	D	E	F
0		ø	œ	P	`	p	ç	é	á	ø		ø	ó	-
1	!	1	A	Q	a	q	ü	æ	í			ð	β	±
2	"	2	B	R	b	r	é	Æ	ó			é	ò	=
3	#	3	C	S	c	s	â	ô	ú			ë	ò	¼
4	\$	4	D	T	d	t	ä	ö	ñ			è	ø	¶
5	%	5	E	U	e	u	à	ò	ñ	á		€	ø	§
6	&	6	F	V	f	v	à	û	æ	â	ã	í	µ	÷
7	'	7	G	W	g	w	ç	ù	ø	à	ã	î	þ	,
8	<	8	H	X	h	x	è	ÿ	ú	ø		ï	þ	°
9	>	9	I	Y	i	y	ë	ö	«				ó	”
A	*	:	J	Z	j	z	è	ü	¬				ô	+
B	+	;	K	L	k	{	ï	ø	¼				ù	
C	,	<	L	\	l		î	£	¼				ý	³
D	-	=	M	J	m	}	ì	ŕ	;	ø		ì	ý	²
E	.	>	N	^	n	~	ñ	×	«	¥		ì	~	
F	/	?	O	_	o	⌘	á	f	»		⌘		'	

The print sample shown above is issued with a head density of 8 dots/mm, enlargement ratio of 3 (vertical/horizontal) and DOS 858.

The data from 00 (H) to 1F (H) are control codes and you cannot use them.

[ESC+S] S Font (Basic size 8 x 15 dots)

Hexadecimal code	ESC	S	Parameter
	<1B> ₁₆	<53> ₁₆	n...n
Initial value	Nil		

Valid range and term of command	When the power is OFF	The set parameter is not maintained.
	Valid range within items	The set parameter becomes invalid.
	Valid range between items	The set parameter becomes invalid.

[Function]

Font with the basic size of: width 8 dots, height 15 dots is specified.

[Format]

<S>n...n

- Parameter

n [Print data] = Data

[Coding Example]

```
<A>
<V>100<H>200<P>2<L>0304<S>ABCDE
<Q>2
<Z>
```

[Supplementary Explanation]

- The S font only allows the setting of a fixed pitch.
- The character set varies according to setting of <CE> command.

[Valid Commands]

Print position	<V>	<H>								
Modification	<P>	<L>	<%>	<F>	<&>	</>	<0>	<WD>		
Barcode	<D><d>	<BL><d>								

S font character set

Basic size is 8 x 15 dots (width x height)

S FONT(L0303) 203DP I

	2	3	4	5	6	7	8	9	A	B	C	D	E	F
0		0	@	P	'	p	Ç	É	á	Ø		ø	ó	-
1	!	1	A	Q	a	q	ü	æ	í			Ð	β	±
2	"	2	B	R	b	r	é	Æ	ó			Ê	ô	=
3	#	3	C	S	c	s	â	ô	ú			Ë	ò	¾
4	\$	4	D	T	d	t	ä	ö	ñ			È	õ	¶
5	%	5	E	U	e	u	à	ò	Ñ	Á		€	õ	ø
6	&	6	F	V	f	v	à	û	â	Â	ã	í	μ	÷
7	'	7	G	W	g	w	ç	ù	º	À	Ã	î	þ	,
8	(8	H	X	h	x	ê	ÿ	¿	©		ï	þ	°
9)	9	I	Y	i	y	ë	ö	®				ú	”
A	*	:	J	Z	j	z	è	ü	™				û	•
B	+	;	K	L	k	{	ï	ø	½				ù	¡
C	,	<	L	\	l		î	£	¼				ý	³
D	-	=	M]	m	}	ì	ø	¡	¢		ı	ý	²
E	.	>	N	^	n	~	Ä	X	«	¥		ì	˘	
F	/	?	O	_	o	■	À	f	»		◊		˘	

The print sample shown above is issued with a head density of 8 dots/mm, enlargement ratio of 3 (vertical/horizontal) and DOS 858.

The data from 00 (H) to 1F (H) are control codes and you cannot use them.

[ESC+M] M Font (Basic size 13 x 20 dots)

Hexadecimal code	ESC	M	Parameter
	<1B> ₁₆	<4D> ₁₆	n...n
Initial value	Nil		

Valid range and term of command	When the power is OFF	The set parameter is not maintained.
	Valid range within item	The set parameter becomes invalid.
	Valid range between items	The set parameter becomes invalid.

[Function]

Font with the basic size of: width 13 dots, height 20 dots is specified.

[Format]

<M>n...n

- Parameter

n [Print data] = Data

[Coding Example]

```
<A>
<V>100<H>200<P>2<L>0304<M>ABCDE
<Q>2
<Z>
```

[Supplementary Explanation]

- The M font only allows the setting of a fixed pitch.
- The character set varies according to setting of <CE> command.

[Valid Commands]

Print position	<V>	<H>								
Modification	<P>	<L>	<%>	<F>	<&>	</>	<0>	<WD>		
Barcode	<D><d>	<BL><d>								

M font character set

Basic size is 13 x 20 dots (width x height)

M FONT (L0202) 203DP I

	2	3	4	5	6	7	8	9	A	B	C	D	E	F
0		ø	@	P	'	p	Ç	É	á	Ø		ö	ó	-
1	!	1	A	Q	a	q	ü	æ	í			Ð	β	±
2	”	2	B	R	b	r	é	Æ	ó			Ê	Ô	=
3	#	3	C	S	c	s	â	ô	ú			Ë	Ò	¾
4	\$	4	D	T	d	t	ä	ö	ñ			È	õ	¶
5	%	5	E	U	e	u	à	ò	Ñ	Á		€	Ï	§
6	&	6	F	V	f	v	å	û	ä	Â	ã	í	μ	÷
7	'	7	G	W	g	w	ç	ù	º	À	Ã	î	þ	,
8	(8	H	X	h	x	ê	ÿ	¿	©		ÿ	Þ	°
9)	9	I	Y	i	y	ë	ö	®				Ú	”
A	*	:	J	Z	j	z	è	ü	¬				Û	•
B	+	;	K	[k	{	ï	ø	½				Ü	¡
C	,	<	L	\	l		î	£	¼				Ý	³
D	-	=	M]	m	}	ì	Ø	ì	¢		ì	Ý	²
E	.	>	N	^	n	~	Ä	X	«	¥		ì	-	
F	/	?	O	_	o	■	Å	f	»		⊗		'	

The print sample shown above is issued with a head density of 8 dots/mm, enlargement ratio of 2 (vertical/horizontal) and DOS 858.

The data from 00 (H) to 1F (H) are control codes and you cannot use them.

[ESC+WB] WB Font (Basic size 18 x 30 dots)

Hexadecimal code	ESC	WB	Parameter
	<1B> ₁₆	<57> ₁₆ <42> ₁₆	an...n
Initial value	Nil		

Valid range and term of command	When the power is OFF	The set parameter is not maintained.
	Valid range within item	The set parameter becomes invalid.
	Valid range between items	The set parameter becomes invalid.

[Function]

Font with the basic size of: width 18 dots, height 30 dots is specified.

[Format]

<WB>an...n

- Parameter
 - a [Smoothing]
 - 0: Smoothing OFF
 - 1: Smoothing ON (Valid for Enlargement <L> between 3 and 12)
 - n [Print data] = Data

[Coding Example]

```
<A>
<V>100<H>200<P>2<L>0304<WB>0ABCDE
<Q>2
<Z>
```

[Supplementary Explanation]

- The WB font only allows the setting of a fixed pitch.
- When the smoothing is enabled, and the Enlargement <L> is set to 1 or 2 or from 13 to 36, the smoothing function will be ignored.
- The character set varies according to setting of <CE> command.

[Valid Commands]

Print position	<V>	<H>								
Modification	<P>	<L>	<%>	<F>	<&>	</>	<0>	<WD>		
Barcode	<D><d>	<BL><d>								

WB font character set

Basic size is 18 x 30 dots (width x height)

WB FONT(L0101) 203DPI

	2	3	4	5	6	7	8	9	A	B	C	D	E	F
0		0	@	P	'	p	Ç	É	á	Ø		ð	ó	-
1	!	1	A	Q	a	q	ü	æ	í			Ð	β	±
2	"	2	B	R	b	r	é	Æ	ó			Ê	ô	=
3	#	3	C	S	c	s	â	ô	ú			Ë	ò	¾
4	\$	4	D	T	d	t	ä	ö	ñ			È	õ	¶
5	%	5	E	U	e	u	à	ò	Ñ	Á		€	õ	§
6	&	6	F	V	f	v	â	û	ä	Â	ã	í	μ	÷
7	'	7	G	W	g	w	ç	ù	ó	À	Ã	î	þ	,
8	(8	H	X	h	x	ê	ÿ	¿	©		ï	þ	°
9)	9	I	Y	i	y	ë	ö	®				ú	¨
A	*	:	J	Z	j	z	è	ü	¬				û	•
B	+	;	K	[k	{	ï	ø	½				ù	¡
C	,	<	L	\	l	!	î	£	¼				ý	³
D	-	=	M]	m	}	ì	Ø	ì	∅		!	ý	²
E	.	>	N	^	n	~	Ä	x	«	¥		ì	-	
F	/	?	O	_	o	■	Å	f	»		α		'	

The print sample shown above is issued with a head density of 8 dots/mm, enlargement ratio of 1 (vertical/horizontal) and DOS 858.

The data from 00 (H) to 1F (H) are control codes and you cannot use them.

[ESC+WL] WL font (Basic size 28 x 52 dots)

Hexadecimal code	ESC	WL	Parameter
	<1B> ₁₆	<57> ₁₆ <4C> ₁₆	an...n
Initial value	Nil		

Valid range and term of command	When the power is OFF	The set parameter is not maintained.
	Valid range within items	The set parameter becomes invalid.
	Valid range between items	The set parameter becomes invalid.

[Function]

Font with the basic size of: width 28 dots, height 52 dots is specified.

[Format]

<WL>an...n

- Parameter
 - a [Smoothing]
 - 0: Smoothing OFF
 - 1: Smoothing ON (Valid for Enlargement <L> between x3 and 12)
 - n [Print data] = Data

[Coding Example]

```
<A>
<V>100<H>200<P>2<L>0304<WL>0ABCDE
<Q>2
<Z>
```

[Supplementary Explanation]

- The WL font only allows the setting of a fixed pitch.
- When the smoothing is enabled, and the Enlargement <L> is set to 1 or 2 or from 13 to 36, the smoothing function will be ignored.
- The character set varies according to setting of <CE> command.

[Valid Commands]

Print position	<V>	<H>								
Modification	<P>	<L>	<%>	<F>	<&>	</>	<0>	<WD>		
Barcode	<D><d>	<BL><d>								

WL font character set

Basic size is 28 x 52 dots (width x height)

WL FONT(L0101) 203DP I

	2	3	4	5	6	7	8	9	A	B	C	D	E	F
0		0	@	P	'	p	Ç	É	á	Ø		ø	ó	-
1	!	1	A	Q	a	q	ü	æ	í			Ð	β	±
2	”	2	B	R	b	r	é	Æ	ó			Ê	Ô	=
3	#	3	C	S	c	s	â	ô	ú			Ë	Ò	¾
4	\$	4	D	T	d	t	ä	ö	ñ			È	Õ	π
5	%	5	E	U	e	u	à	ò	Ñ	Á		€	Ö	§
6	&	6	F	V	f	v	å	û	ä	Â	ã	Í	μ	÷
7	'	7	G	W	g	w	ç	ù	º	À	Ã	Î	þ	,
8	(8	H	X	h	x	ê	ÿ	¿	©		Ï	Þ	°
9)	9	I	Y	i	y	ë	ö	®				Ú	¨
A	*	:	J	Z	j	z	è	ü	¬				Û	•
B	+	;	K	[k	{	ï	ø	½				Ü	¹
C	,	<	L	\	l		î	£	¼				Ý	³
D	-	=	M]	m	}	ì	Ø	¡	¢		!	Ý	²
E	.	>	N	^	n	~	Ä	x	«	¥		ì	˘	
F	/	?	O	_	o	■	Å	f	»		α		˘	

The print sample shown above is issued with a head density of 8 dots/mm, enlargement ratio of 1 (vertical/horizontal) and DOS 858.

The data from 00 (H) to 1F (H) are control codes and you cannot use them.

[ESC+\$] Outline Font Design

Hexadecimal code	ESC	\$	Parameter
	<1B> ₁₆	<24> ₁₆	a,bbb,ccc,d
Initial value	a=A,bbb=50,ccc=50,d=0		

Valid range and term of command	When the power is OFF	The set parameter is not maintained.
	Valid range within items	The set parameter is valid until the next valid setting.
	Valid range between items	The set parameter becomes initial value at the next item <A>.

[Function]

Specifying the type, size, and shape of font.

[Format]

<\$>a,bbb,ccc,d

- Parameter
 - a [Font type]
 - A: Helvetica bold (Proportional)
 - B: Helvetica bold (Inter-character pitch fixed)
 - K: Kanji specified by hexadecimal number^{*1}
 - L: Kanji specified by binary number^{*1}
 - k: Kanji (vertical) specified by hexadecimal number^{*1}
 - l: Kanji (horizontal) specified by hexadecimal number^{*1}
 - b [Font width] = Valid range: 1 to 999 dots
 - c [Font height] = Valid range: 1 to 999 dots
 - d [Font design]
 - 0: Normal font (Black)
 - 1: White characters on black background
 - 2: Grey font (Pattern 1)
 - 3: Grey font (Pattern 2)
 - 4: Grey font (Pattern 3)
 - 5: Font with shadow
 - 6: White characters with shadow on black background
 - 7: Mirrored font
 - 8: Normal italic font
 - 9: White italic characters with shadow on black background

*1 Will specify Kanji outline font

[Coding example]

Font type: A, font width: 100 dots,

font height: 100 dots, font design: 1

<A>

<V>100<H>100<P>2

<\$>A,100,100,1<\$=>SATO

<Q>2

<Z>

[Supplementary Explanation]

- Italic characters are tilt in an angle of 15-degree, within their specified width.
- The outline font printing command <\$=> shall be executed after the outline font design selection <\$>.
- For the font design 1 thru 9, if the specified dot setting is irregularly small, the font cannot be identified.
- If the font width / height are very small, there can be cases that the font is squeezed.

[Valid Commands]

Font	<\$=>									
------	-------	--	--	--	--	--	--	--	--	--

Outline Font Design

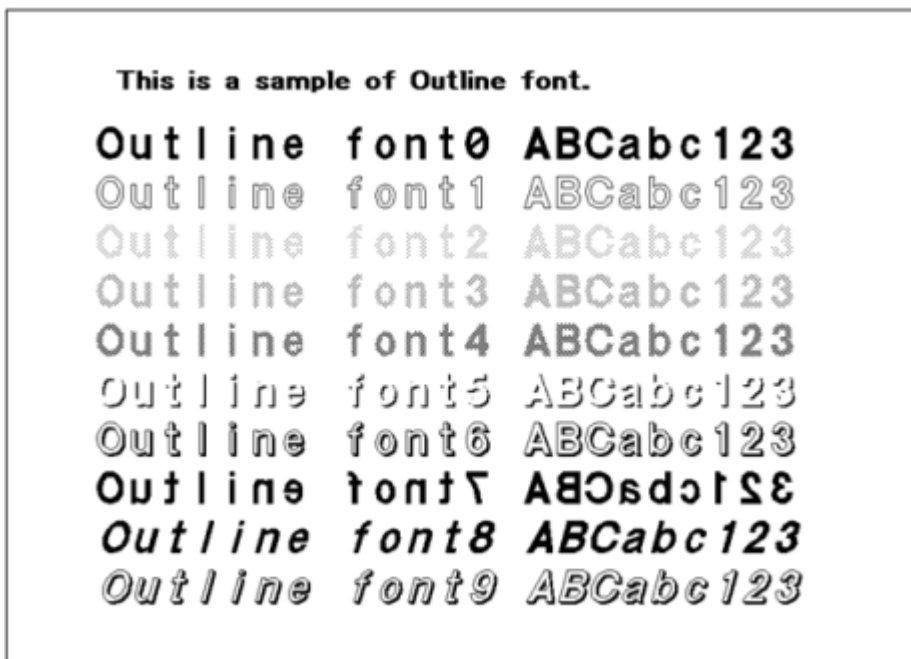

The print sample shown above is issued with a head density of 8 dots/mm.

[ESC+\$=] Outline Font Print

Hexadecimal code	ESC	\$=	Parameter
	<1B> ₁₆	<24> ₁₆ <3D> ₁₆	n...n
Initial value	Nil		

Valid range and term of command	When the power is OFF	The set parameter is not maintained.
	Valid range within items	The set parameter becomes invalid.
	Valid range between items	The set parameter becomes invalid.

[Function]

Specifying printing command of outline font.

[Format]

<\$=>n...n

- Parameter

n [Print data] = Data

[Coding example]

Print data: SATO

<A>

<V>100<H>100<P>2

<\$>A,100,100,1<\$=>**SATO**

<Q>2

<Z>

[Supplementary Explanation]

- The outline font printing command <\$=> shall be executed after the outline font design selection <\$>.
- Font height includes both ascender and descender area. For proportional pitch, the character width of outline font differs depending on the font to be used.
- Use character pitch command <P> to specify font pitch.
- Italic characters are tilt in an angle of 15-degree, within their specified width. As for the height specification, both ascender and descender area are included.
- For the font design 1 through 9, if the specified dot setting is irregularly small, the font cannot be identified.
- If the font width / height are very small, there can be cases that the font is squeezed.
- JIS, Shift JIS, or Unicode (UTF-16, UTF-8) can be used for Kanji outline font, which should correspond with the printer settings to proper printing. Specify Kanji code by <KC> command or LCD setting.

[Valid Commands]

Print position	<V>	<H>								
Modification	<P>	<%>	<\$>	<F>						

Outline Font Character Set

Characters consists of 50 x 50 dots, Standard font (Black)

OUTLINE FONTØ 2Ø3DPI

	2	3	4	5	6	7	8	9	A	B	C	D	E	F
Ø		Ø	@	P	'	p	Ç	É	á			ø	Ó	–
1	!	1	A	Q	a	q	ü	æ	í			Ð	β	±
2	"	2	B	R	b	r	é	Æ	ó			Ê	Ô	=
3	#	3	C	S	c	s	â	ô	ú			Ë	Ò	¾
4	\$	4	D	T	d	t	ä	ö	ñ			È	õ	
5	%	5	E	U	e	u	à	ò	Ñ	Á		€	Õ	
6	&	6	F	V	f	v	â	û	a	Â	ã	í	μ	÷
7	'	7	G	W	g	w	ç	ù	ø	À	Ã	î	þ	.
8	(8	H	X	h	x	ê	ÿ	ı	©		ï	ƒ	°
9)	9	I	Y	i	y	ë	Ö	®			Ú	”	
A	*	:	J	Z	j	z	è	Ü	¬			Û	.	
B	+	;	K	[k	{	ï	ø	½			Ù	'	
C	,	<	L	\	l		î	£	¼			ý	³	
D	-	=	M]	m	}	ì	Ø	ı	¢		Ý	²	
E	.	>	N	^	n	~	Ä	×	«	¥		ì	¯	
F	/	?	O	_	o		Å	f	»			'		

The print sample shown above is issued with a head density of 8 dots/mm.

The data from 00 (H) to 1F (H) are control codes and you cannot use them.

[ESC+RD] CG Font

Hexadecimal code	ESC	RD	Parameter
	<1B> ₁₆	<52> ₁₆ <44> ₁₆	abc,ddd,eee,n...n
Initial value	b=0		

Valid range and term of command	When the power is OFF	The set parameter is not maintained.
	Valid range within items	The set parameter becomes invalid.
	Valid range between items	The set parameter becomes invalid.

[Function]

Specifying CG font type, font style, font size, and print data.

[Format]

<RD>abc,ddd,eee,n...n

- Parameter
 - a [Font type]
 - A [SATO CG Sleek]
 - B [SATO CG Stream]

Symbol	Parameter name	Setting value	Character set
b	Character encoding selection	-	Character set specified by <CE>
		0	858 (default)
		1	ISO 8859/1 Latin 1
		2	ISO 8859/2 Latin 2
		3	ISO 8859/9 Latin 5
		4	CP737 DOS Greek
		5	CP855 DOS Cyrillic
		6	-
		7	-
		8	PC-850 Multilingual
		9	CP852 DOS Central European
		A	CP857 DOS Turkish
		B	CP866 DOS Cyrillic II
		C	CP1250 Windows Central European
		D	CP1251 Windows Cyrillic
		E	CP1252 Windows Western Latin 1
F	CP1253 Windows Greek		
G	CP1254 Windows Turkish		

Symbol	Parameter name	Setting value	Character set
		H	-
		I	-
		J	CP1257 Windows Baltic
		K	CP869 IBM Greek
		L	-
		M	Japanese X0201 *1
		@	Unicode UTF-8

*1: Specifying X0201 prints ISO 8859-1 Latin 1 character set.

c [Font style]

- 0 Standard
- 1 Bold
- 2 Italic
- 3 Bold + Italic

d [Width]

Valid Range: 004 to 999 (dots)
Valid Range: P02 to P99 (points)

e [Height]

Valid Range: 004 to 999 (dots)
Valid Range: P02 to P99 (points)

n [Print data] = Data

[Coding Example1]

Font type: SATO CG Sleek, Width: 10 pts, Height: 10 pts

```
<A>
<V>100<H>100<P>2
<RD>A00,P10,P10,SATO
<Q>2
<Z>
```

[Supplementary Explanation]

- The font size is set by [dot number] or [point number].
- The dot size does vary with printer type. (Refer to the table below)

Head density	Size of 1 dot (mm)
203 dpi (8 dots/mm)	0.125

- 1 point is 0.35 mm.

[Font size range]

Head density	Valid range:	
	Width range (dots)	Height range (dots)
203 dpi	4 to 832	4 to 999

[Valid Commands]

Print position	<V>	<H>								
Modification	<P>	<%>	<F>	<PS>	<PR>					

SATO CG Sleek font character set

SATO CG Sleek font settings

SATO CG Sleek FONT 203DPI

	2	3	4	5	6	7	8	9	A	B	C	D	E	F
0		0	@	P	`	p	Ç	É	á	☐	⊥	ð	Ó	-
1	!	1	A	Q	a	q	ü	æ	í	☐	⊥	Ð	β	±
2	"	2	B	R	b	r	é	Æ	ó	☐	⊥	Ê	Ô	=
3	#	3	C	S	c	s	â	ô	ú		⊥	Ë	Ò	¾
4	\$	4	D	T	d	t	ä	ö	ñ	⊥	—	È	õ	¶
5	%	5	E	U	e	u	à	ò	Ñ	Á	+	€	Õ	§
6	&	6	F	V	f	v	â	û	ª	Â	ã	Í	μ	÷
7	'	7	G	W	g	w	ç	ù	º	À	Ã	Î	þ	,
8	(8	H	X	h	x	ê	ÿ	¿	©	⊥	Ï	Ɔ	°
9)	9	I	Y	i	y	ë	Ö	®	≡	≡	⊥	Ú	“
A	*	:	J	Z	j	z	è	Ü	¬		≡	⊥	Û	•
B	+	;	K	[k	{	ï	ø	½	⊥	⊥	■	Ù	¹
C	,	<	L	\	l		î	£	¼	≡	≡	■	Ý	³
D	-	=	M]	m	}	ì	Ø	¡	©	≡		Ý	²
E	.	>	N	^	n	~	Ä	×	«	¥	≡	Ì	¯	■
F	/	?	O	_	o		Å	f	»	⊥	α	■	'	

Print sample in following condition: Head density: 8 dots/mm, 40 x 40 point, DOS 858.

The data from 00 (H) to 1F (H) are control codes and you cannot use them.

SATO CG Stream font character set

SATO CG Stream Font settings

SATO CG Stream FONT 203DPI

	2	3	4	5	6	7	8	9	A	B	C	D	E	F
0		0	@	P	`	p	Ç	É	á	☐	⊥	ø	Ó	-
1	!	1	A	Q	a	q	ü	æ	í	☐	⊥	Ð	β	±
2	"	2	B	R	b	r	é	Æ	ó	☐	⊥	Ê	Ô	=
3	#	3	C	S	c	s	â	ô	ú		⊥	Ë	Ò	¾
4	\$	4	D	T	d	t	ä	ö	ñ	⊥	—	È	õ	¶
5	%	5	E	U	e	u	à	ò	Ñ	Á	⊥	€	Õ	§
6	&	6	F	V	f	v	å	û	ª	Â	ã	í	μ	÷
7	'	7	G	W	g	w	ç	ù	º	À	Ã	î	þ	·
8	(8	H	X	h	x	ê	ÿ	¿	©	⊥	ï	þ	°
9)	9	I	Y	i	y	ë	Ö	®	⊥	⊥	⊥	Ú	”
A	*	:	J	Z	j	z	è	Ü	¬		⊥	⊥	Û	·
B	+	;	K	[k	{	ï	ø	½	⊥	⊥	■	Ù	1
C	,	<	L	\	l		î	£	¼	⊥	⊥	■	Ý	3
D	-	=	M]	m	}	ì	Ø	¡	¢	—		Ý	2
E	.	>	N	^	n	~	Ä	×	«	¥	⊥	ì	¯	■
F	/	?	O	_	o		Å	f	»	⊥	α	■	'	

Print sample in following condition: Head density: 8 dots/mm, 40 x 40 point, DOS 858.
 The data from 00 (H) to 1F (H) are control codes and you cannot use them.

[ESC+RG] Multiple language

Hexadecimal code	ESC	RG	Parameter
	<1B> ₁₆	<52> ₁₆ <47> ₁₆	a,b,c,ddd,eee,fff...fff
Initial value	Nil		

Valid range and term of command	When the power is OFF	The set parameter is not maintained.
	Valid range within items	The set parameter becomes invalid.
	Valid range between items	The set parameter becomes invalid.

[Function]

Printing multiple language fonts.

[Format]

<RG>a,b,c,ddd,eee,fff...fff

Parameter

- a : [Character code]
Character code of print data to be specified to a parameter f.
Refer to the table below.
- b : [Font set] Font type for printing. Refer to the table below.
- c : [Modification]
0: Standard
1: Italic
2: BOLD
3: BOLD+Italic
- d : [Width]
Valid range: 20 to 999 (dots)
Valid range: P09 to P99 (points)
- e : [Height]
Valid range: 20 to 999 (dots)
Valid range: P09 to P99 (points)
*One point is 0.35 mm.
- f : [Print data] (character code)

[Character code list]

Parameter a	Character code
0	UNICODE (UTF-8)
1	UNICODE (UTF-16BE) *Recommended
2	S-JIS
3	BIG5
4	GB18030
5	KSX 1001 (EUC-KR)
-	Character set specified by <CE>. * If UTF-8 or X201 has been selected by <CE>, it is the value of the following. <CE>: UTF-8、<RG>Parameter a: 0:UTF-8

Parameter a	Character code
	<CE>: X201, <RG>Parameter a: 2:S-JIS

[Font set list]

Parameter b	Font name	Font set	Font type	Character code range (UTF-16BE)
0	SATO Hebe Sans	WGL4	Hebe Serif	0020-FB02
1	SATO Hebe Sans Arabic	Arabic (Farsi) +ISO8859-1	Hebe Serif	0020-00FF, 0600-06FF, FE70-FEFC
2	SATO Hebe Sans Thai	Thai+ISO8859-1	Hebe Serif	0020-00FF, 0E01-0E5B
3	SATO Hebe Sans Hindi	Hindi+ISO8859-1	Hebe Serif	0020-00FF, 0901-097F
4	SATO Gothic Traditional Chinese	WGL4	Hebe Serif	0020-FFE6
		Big5	MobileGothic	
		GB-18030	Crystalzhonghei	
		JISx0208 (+NEC) JISx0201	MobileGothic	
		KSX 1001	MobileGothic	
5	SATO Gothic Japanese	WGL4	Hebe Serif	0020-FFE6
		JISx0208 (+NEC) JISx0201	MobileGothic	
		KSX 1001	MobileGothic	
		GB-18030	Crystalzhonghei	
		Big5	MobileGothic	
6	SATO Gothic Simplified Chinese	WGL4	Hebe Serif	0020-FFE5
		GB-18030	Crystalzhonghei	
7	SATO Gothic Korean	WGL4	Hebe Serif	0020-FFE6
		KSX 1001	MobileGothic	
		JISx0208 (+NEC) JISx0201	MobileGothic	
		GB-18030	Crystalzhonghei	
		Big5	MobileGothic	
8	SATO Silver Serif	WGL4	Silver Serif	0020-FB02
9	SATO Mincho Traditional Chinese	WGL4	Silver Serif	0020-FFE6
		Big5	Mincho	
		GB-18030	Shusong2M	

Parameter b	Font name	Font set	Font type	Character code range (UTF-16BE)
		JISx0208 (+NEC) JISx0201	CrystalMincho	
		KSX 1001	Mincho	
10	SATO Mincho Japanese	WGL4	Silver Serif	0020-FFE6
		JISx0208 (+NEC) JISx0201	CrystalMincho	
		KSX 1001	Mincho	
		GB-18030	Shusong2M	
		Big5	Mincho	
11	SATO Mincho Simplified Chinese	WGL4	Silver Serif	0020-FFE5
		GB-18030	Shusong2M	
12	SATO Mincho Korean	WGL4	Silver Serif	0020-FFE6
		KSX 1001	Mincho	
		JISx0208 (+NEC) JISx0201	CrystalMincho	
		GB-18030	Shusong2M	
		Big5	Mincho	
13	SATO Roman Arabic	Arabic+ISO8859-1	Roman	0020-00FF, 0600-06FF, FDF2, FE70-FEFC
14	SATO Hebe Sans Hebrew	Hebrew +ISO8859-1	Hebe Serif	0020-00FF, 05B0-05F4, FB1D-FB4F

[Coding example]

Character code = UTF16, Font set = SJIS, Modification = Standard, Width = 20 dots, Height = 20 dots, Print data = SATO

```
<A>
<V>100<H>100<P>2
<RG>1,5,0,20,20,<FF33>16<FF21>16<FF34>16<FF2F>16
<Q>2
<Z>
```

[Note]

- When a character code other than UTF-16BE is specified, the character code will be converted into UTF-16BE. If there were codes that cannot be converted, they are replaced by single spaces.
- When UTF-16BE is specified as a character code or character codes do not exist in the font set after UTF-16BE conversion, these character codes are not printed. When a space or a square are filled in the font set for the character code, these images are printed.
- Print size may be smaller than specified character size with parameter in landscape and portrait directions due to multi languages.

- If input code is set to UTF-8, the size of character code is available up to 4 bytes. UTF-8 does not support 5, 6 bytes.
- UTF-16BE supports up to 2 byte character code. 3 bytes UTF-8 and 4 bytes UTF-16BE are not supported.
- Complex script languages (Arabic, Hindi, Thai), Hebrew are printed with proportional fonts, regardless of setting of font type in order to use the formatter function and the combined font function.
- The linefeed code cannot be inserted among one word or one character code forming one character for the complex script languages (Arabic, Hindi, Thai), Hebrew. If the linefeed is inserted, the rendering result is not guaranteed.
- Comply with Unicode 2.1 (note that if the first byte is 0x1b when UTF-16BE is specified, it is judged as a ESC code).
- When performing sequential number printing in Arabic, Hindi, Thai and Hebrew, the character codes are rendered as a character string and it may not function properly.
- This command does not support partial editing because the complex script languages (Arabic, Hindi, Thai), Hebrew extract the character string for using the formatter function and the combined font function.
- Complex script languages (Arabic, Hindi, Thai), Hebrew render character codes as character strings in order to use the formatter function and the combined font function. Other languages render character codes in character units, so that a gap between fonts is different from that of the complex script languages.
- Note that when a combination of character codes and font sets is other than below table, the expected character may not be printed.

Font set	Character code
WGL4, Arabic, Thai, Hindi, Hebrew	UNICODE (UTF-16BE), UNICODE (UTF-8)
Big5	UNICODE (UTF-16BE), Big5, UNICODE (UTF-8)
SJIS	UNICODE (UTF-16BE), SJIS , UNICODE (UTF-8)
GB18030	UNICODE (UTF-16BE), GB18030, UNICODE (UTF-8)
KSX1001 (EUC-KR)	UNICODE (UTF-16BE), KSX1001 (EUC-KR), UNICODE(UTF-8)

- SATO Roman Arabic does not correspond to Farsi.
- Recommended fonts if you specify "-" in parameter a and print character set of <CE>

<CE>		<RG>	
Parameter a	Official name	Parameter b	Font name
858	DOS 858	0	SATO Hebe Sans
88591	ISO 8859/1	8	SATO Silver Serif
88592	ISO 8859/2		
88599	ISO 8859/9		
850	DOS 850		
852	DOS 852		
855	DOS 855		

<CE>		<RG>	
Parameter a	Official name	Parameter b	Font name
857	DOS 857		
737	DOS 737		
866	DOS 866		
1250	Win 1250		
1251	Win 1251		
1252	Win 1252		
1253	Win 1253		
1254	Win 1254		
1257	Win 1257		
869	IBM 869		
UTF-8	UTF-8		
201	X0201		

- Font of parameter b0-14 is not installed with printer by default. The font shall be downloaded to printer before using this command.

[Valid Commands]

Print position	<V>	<H>								
Modification	<P>	<%>	<F>	<PS>	<PR>					

Multiple language sample

b	Fontname	Sample
8	SATO Hebe Sans	This is a fontsample.
8	SATO Silver Serif	This is a fontsample.
1	SATO Hebe Sans Arabic	هذا هو عينة من الخط.
13	SATO Roman Arabic	هذا هو عينة من الخط.
2	SATO Hebe Sans Thai	นี่คือตัวอย่างของตัวอักษร
3	SATO Hebe Sans Hindi	इस फॉन्ट का एक नमूना है.
14	SATO Hebe Sans Hebrew	זוהי דוגמה של הגופן.
4	SATO Gothic Tradional Chinese	這是字體的樣本。
9	SATO Mincho Tradional Chinese	這是字體的樣本。
6	SATO Gothic Simplified Chinese	这是字体的样本。
11	SATO Mincho Simplified Chinese	这是字体的样本。
5	SATO Gothic Japanese	これはフォントのサンプルです。
10	SATO Mincho Japanese	これはフォントのサンプルです。
7	SATO Gothic Korean	이것은 글꼴의 샘플입니다.
12	SATO Mincho Korean	이것은 글꼴의 샘플입니다.

Print sample in following condition: Head density: 8 dots/mm, 28 x 28 point

[ESC+RH] Scalable font

Hexadecimal code	ESC	RH	Parameter
	<1B> ₁₆	<52> ₁₆ <47> ₁₆	a,b...b,c,ddd,eee,f...f
Initial value	Nil		

Valid range and term of command	When the power is OFF	The set parameter is not maintained.
	Valid range within items	The set parameter becomes invalid.
	Valid range between items	The set parameter becomes invalid.

[Function]

Built-in scalable font and the TTF font downloaded using file download [DC2]DE of a common command are printed.

[Format]

<RH>a,b...b,c,ddd,eee, fff...fff

Parameter

- a [Character code]
Input character code of printing data specifying to parameter f.
See the table "Input character code list" below.
- b [Font set] = Valid range: See the table "Built-in font set list" below.
- c [Modification]
0: Standard
1: Bold
2: Italic
3: Bold + Italic
- d [Width]
Valid range: 020 to 999 (dots)
Valid range: P09 to P99 (points)
- e [Height]
Valid range: 020 to 999 (dots)
Valid range: P09 to P99 (points)
*One point is 0.35 mm.
*The valid range of height and width is 832 dots for 203 dpi.
- f [Print Data] = Data

[Input character code list]

Parameter a	Character code
0	UNICODE(UTF-8)
1	UNICODE(UTF-16BE) * Recommended
2	S-JIS
3	BIG5
4	GB18030
5	KSX 1001(EUC-KR)
-	Character set specified by <CE>. * If UTF-8 or X201 has been selected by <CE>, it is the value of the following.

Parameter a	Character code
	<CE>: UTF-8, <RH> parameter a: 0:UTF-8 <CE>: X201, <RH> parameter a: 2:S-JIS

[Built-in font set list]

Parameter b	Font name
SATOCGSleek.ttf	SATO CG Sleek
SATOCGStream.ttf	SATO CG Stream
SATOOOCRA.ttf	SATO OCR-A
SATO0.ttf	SATO 0
SATOALPHABC.ttf	SATO Alpha Bold Condensed
SATOBETABI.ttf	SATO Beta Bold Italic
SATOFOLIOB.ttf	SATO Folio Bold
SATOFUTURAMC.ttf	SATO Futura Medium Condensed
SATOGAMMA.ttf	SATO Gamma
SATOOOCR.ttf	SATO OCR-B
SATOSANS.ttf	SATO Sans
SATOSERIF.ttf	SATO Serif
SATOSYM.ttf	SATO Symbol Set
SATOVICA.ttf	SATO Vica
SATOWING.ttf	SATO WingBats

[Coding example1] Printing of the built-in (scalable) font

Character code=UTF16BE, Font set=SATO CG Stream, Modification=Standard, Width=20 dots, Height=20 dots, Print data=SATO

```
<A>
<V>100<H>100<P>2
<RH>1,SATOCGStream.ttf,0,20,20,<FF33>_16<FF21>_16<FF34>_16<FF2F>_16
<Q>2
<Z>
```

[Coding example2] Printing of the downloaded TrueType font

Character code=UTF16BE, Font set(The downloaded file name)=sample.ttf, Modification=Standard, Width=40 dots, Height=40 dots, Print data=SATO

```
<A>
<V>100<H>100<P>2
<RH>1,sample.ttf,0,40,40,<FF33>_16<FF21>_16<FF34>_16<FF2F>_16
<Q>2
<Z>
```

[Coding example3] Printing of the downloaded TrueType font

Character code=UTF16BE,Font set(The downloaded file name)=Sample.TTF,
Modification=Standard, Width=40 dots, Height=40 dots, Print data=SATO

```
<A>
<V>100<H>100<P>2
<RH>1,sample.TTF,0,40,40<FF33>16<FF21>16<FF34>16<FF2F>16
<Q>2
<Z>
```

[Note]

- When a character code other than UTF-16 is specified, the character code will be converted into UTF-16. If there are character codes that cannot be converted, all character strings specified as a parameter error will be printed.
- If the font corresponding to specified character code does not exist, an invalid image defined in the font set will be printed.
- Supports only the TTF that supports Unicode (UTF-16BE). If TTF does not support Unicode (UTF-16BE), the specified character code is printed as GID (Glyph Index).
- Recommended fonts if you specify "-" in parameter a and print character set of <CE>

<CE>		<RH>	
Parameter a	Official name	Parameter b	Font name
858	DOS 858	SATOCGSleek.ttf	SATO CG Sleek
88591	ISO 8859/1	SATOCGStream.ttf	SATO CG Stream
88592	ISO 8859/2		
88599	ISO 8859/9		
850	DOS 850		
852	DOS 852		
855	DOS 855		
857	DOS 857		
737	DOS 737		
866	DOS 866		
1250	Win 1250		
1251	Win 1251		
1252	Win 1252		
1253	Win 1253		
1254	Win 1254		
1257	Win 1257		
869	IBM 869		
UTF-8	UTF-8		
201	X0201	-	-

- Size that can be specified in the "character set" is up to 32 bytes. Also, you can specify character will be only the following characters.

- Alphabet
 - Number
 - Hyphen [-]
 - Underscore [_]
 - Period [.]
- Character may not be printed correctly if small character size is specified to downloaded TTF font. Please fully check on print result.
 - Print size may be smaller than specified character size with parameter in landscape and portrait directions due to multi languages.
 - If input code is set to UTF-8, the size of character code is available up to 4 bytes. UTF-8 does not support 5, 6 bytes.
 - Formatter functionality and Ligature functionality are used for complex languages (Arabic, Hindi, Thai) and Hebrew so that proportional is enabled for print regardless of how proportional was set.
 - It is not possible to specify line feed code to in between character codes which forms single word and single character for complex languages (Arabic, Hindi, Thai) and Hebrew. Rendering result is not guaranteed if line feed code is specified.
 - Please note that it is determined as ESC code if the first byte is 0x1b when UTF-16BE is specified.
 - If the first 2 bytes are specified to range of surrogate pairs (0xD800 to 0xDBFF) when UTF-16BE is specified, it will be replaced with half size space on the condition that the last 2 bytes are not within the range of surrogate pairs (0xDC00 to 0xDFFF).
 - Please note that serialized print may not work properly for languages like Arabic, Hindi, Thai, and Hebrew because any input character code for those languages are rendered as character string and this will cause incorrect print position.
 - Formatter functionality and Ligature functionality are used for complex languages (Arabic, Hindi, Thai) and Hebrew so that any input codes are rendered as character string. Input character codes for other languages than above-mentioned languages are rendered per character so that character gap is different between complex language and other languages.
 - Please note that you may not get character as you expected after it is printed if the combination of input character code and character set is different from the table below.

[Valid Commands]

Print position	<V>	<H>								
Modification	<P>	<%>	<F>	<PS>	<PR>					

Scalable font sample

Fontname	Sample
SATOCGSleek.ttf	ABCXYZabcdefghijklmnopqrstuvwxyz123
SATOCGStream.ttf	ABCXYZabcdefghijklmnopqrstuvwxyz123
SAT00CRA.ttf	ABCXYZabcdefghijklmnopqrstuvwxyz123
SAT00.ttf	ABCXYZabcdefghijklmnopqrstuvwxyz123
SATOALPHABC.ttf	ABCXYZabcdefghijklmnopqrstuvwxyz123
SATOBETABI.ttf	<i>ABCXYZabcdefghijklmnopqrstuvwxyz123</i>
SATOFOLIOB.ttf	ABCXYZabcdefghijklmnopqrstuvwxyz123
SATOFUTURAMC.ttf	ABCXYZabcdefghijklmnopqrstuvwxyz123
SATOGAMMA.ttf	ABCXYZabcdefghijklmnopqrstuvwxyz123
SAT00CRB.ttf	ABCXYZabcdefghijklmnopqrstuvwxyz123
SATOSANS.ttf	ABCXYZabcdefghijklmnopqrstuvwxyz123
SATOSERIF.ttf	ABCXYZabcdefghijklmnopqrstuvwxyz123
SATOSYM.ttf	f/...√∞~HΘIηθι678
SATOVICA.ttf	ABCXYZabcdefghijklmnopqrstuvwxyz123
SATOWING.ttf	☺☻☼☽☾☿♁♂♃♄♅♆♇♈♉♊♋♌♍♎♏♐♑♒♓♔♕♖♗♘♙♚♛♜♝♞♟♠♡♢♣♤♥♦♧♨♩♪♫♬♭♮♯♰♱♲♳♴♵♶♷♸♹♺♻♼♽♾♿

Print sample in following condition: Head density: 8 dots/mm, 30 x 30 point

[ESC+K1] 16 x 16 dots Kanji in horizontal line

Hexadecimal code	ESC	K1	Parameter
	<1B> ₁₆	<4B> ₁₆ <31> ₁₆	an...n
Initial value	Nil		

Valid range and term of command	When the power is OFF	The set parameter is not maintained.
	Valid range within items	The set parameter becomes invalid.
	Valid range between items	The set parameter becomes invalid.

[Function]

Specifying 16 x 16 (width x height) dots horizontal written Kanji character print.

[Format]

<K1>an...n

- Parameter

a [Kanji selection mode]

H: HEX characters

B: Binary code

I: HEX characters, smoothing function

C: Binary code, smoothing function

J: HEX characters, highlighting function

D: Binary code, highlighting function

K: HEX characters, smoothing and highlighting function

E: Binary code, smoothing and highlighting function

n [Data] = Print data. For the available character codes, refer to Kanji code (ESC+KC) command.

[Coding example 1]

Shift JIS HEX characters, Horizontal enlargement ratio: 3, Vertical enlargement ratio: 5

<A>

<KC>1

<V>100<H>200<P>2<L>0305

<K1>H81698A94816A83548367815B

<Q>2

<Z>

[Coding example 2]

JIS binary code, Horizontal enlargement ratio: 2, Vertical enlargement ratio: 3

<A>

<KC>0

<V>100<H>200<P>2<L>0203

<K1>B!J3T!K%5%H!<

<Q>2

<Z>

[Supplementary Explanation]

- HEX characters = Kanji Code 4 bytes ASCII / 1 Kanji character (Ex.Shift JIS code)
- Binary code = Kanji Code 2 bytes / 1 Kanji character (Ex.Shift JIS code)
- Smoothing function validity range = Horizontal/vertical valid range: factor 3 to 12

- Highlighting function validity range = Horizontal/vertical valid range: factor 1 to 5
- When the language setting of the printer is Japanese or Simplified Chinese or Traditional Chinese or Korean, printing follows the language setting.
- Some JIS213 Kanji (JISX213) characters have values between U+10000 to U+10FFFF.

Both UTF-8 and UTF-16 encodings are supported. Characters are encoded as surrogate pairs in UTF-16, and as a 4 byte code in UTF-8. Some encoding processes use CESU-8, which converts a surrogate pair to UTF-8.

[Notes]

- With the highlighting function the character width enlarges proportional with the expansion factor.
- Using the highlighting function, depending on the type of font, characters become squeezed.
- When the Kanji mode setting is [China, Traditional Chinese (BIG5)], it will be a command error.

[Valid Commands]

Print position	<V>	<H>								
Modification	<P>	<L>	<%>	<&>	</>	<0>	<WD>			

[ESC+K2] 24 x 24 dots Kanji in horizontal line

Hexadecimal code	ESC	K2	Parameter
	<1B> ₁₆	<4B> ₁₆ <32> ₁₆	an...n
Initial value	Nil		

Valid range and term of command	When the power is OFF	The set parameter is not maintained.
	Valid range within items	The set parameter becomes invalid.
	Valid range between items	The set parameter becomes invalid.

[Function]

Specifying 24 x 24 (width x height) dots horizontal written Kanji character print.

[Format]

<K2>an...n

- Parameter

a [Kanji selection mode]

H: HEX characters

B: Binary code

I: HEX characters, smoothing function

C: Binary code, smoothing function

J: HEX characters, highlighting function

D: Binary code, highlighting function

K: HEX characters, smoothing and highlighting function

E: Binary code, smoothing and highlighting function

n [Data] = Print data. For the available character codes, refer to Kanji code (ESC+KC) command.

[Coding example 1]

Shift JIS HEX characters, Horizontal enlargement ratio: 3, Vertical enlargement ratio: 5

<A>

<KC>1

<V>100<H>200<P>2<L>0305

<K2>H81698A94816A83548367815B

<Q>2

<Z>

[Coding example 2]

JIS binary code, Horizontal enlargement ratio: 2, Vertical enlargement ratio: 3

<A>

<KC>0

<V>100<H>100<P>2<L>0203

<K2>B!J3T!K%5%H!<

<Q>2

<Z>

[Supplementary Explanation]

- HEX characters = Kanji Code 4 bytes ASCII / 1 Kanji character (Ex.Shift JIS code)
- Binary code = Kanji Code 2 bytes / 1 Kanji character (Ex.Shift JIS code)
- Smoothing function validity range = Horizontal/vertical valid range: factor 3 to 12

- Highlighting function validity range = Horizontal/vertical valid range: factor 1 to 5
- When the language setting of the printer is Japanese or Simplified Chinese or Traditional Chinese or Korean, printing follows the language setting.
- Some JIS213 Kanji (JISX213) characters have values between U+10000 to U+10FFFF.

Both UTF-8 and UTF-16 encodings are supported. Characters are encoded as surrogate pairs in UTF-16, and as a 4 byte code in UTF-8. Some encoding processes use CESU-8, which converts a surrogate pair to UTF-8.

[Notes]

- With the highlighting function the character width enlarges proportional with the expansion factor.
- Using the highlighting function, depending on the type of font, characters become squeezed.

[Valid Commands]

Print position	<V>	<H>								
Modification	<P>	<L>	<%>	<&>	</>	<0>	<WD>			

[ESC+K3] 22 x 22 dots Kanji in horizontal line

Hexadecimal code	ESC	K3	Parameter
	<1B> ₁₆	<4B> ₁₆ <33> ₁₆	an...n
Initial value	Nil		

Valid range and term of command	When the power is OFF	The set parameter is not maintained.
	Valid range within items	The set parameter becomes invalid.
	Valid range between items	The set parameter becomes invalid.

[Function]

Specifying 22 x 22 (width x height) dots horizontal written Kanji character print.

[Format]

<K3>an...n

- [Format]
 - a [Kanji selection mode]
 - H: HEX characters
 - B: Binary code
 - I: HEX characters, smoothing function
 - C: Binary code, smoothing function
 - J: HEX characters, highlighting function
 - D: Binary code, highlighting function
 - K: HEX characters, smoothing and highlighting function
 - E: Binary code, smoothing and highlighting function
 - n [Data] = Print data. For the available character codes, refer to Kanji code (ESC+KC) command.

[Coding example 1]

Shift JIS HEX characters, Horizontal enlargement ratio: 3, Vertical enlargement ratio: 5

```
<A>
<KC>1
<V>100<H>200<P>2<L>0305
<K3>H81698A94816A83548367815B
<Q>2
<Z>
```

[Coding example 2]

JIS binary code, Horizontal enlargement ratio: 2, Vertical enlargement ratio: 3

```
<A>
<KC>0
<V>100<H>100<P>2<L>0203
<K3>B!J3T!K%5%H!<
<Q>2
<Z>
```

[Supplementary Explanation]

- HEX characters = Kanji Code 4 bytes ASCII / 1 Kanji character (Ex.Shift JIS code)
- Binary code = Kanji Code 2 bytes / 1 Kanji character (Ex.Shift JIS code)
- Smoothing function validity range = Horizontal/vertical valid range: factor 3 to 12

- Highlighting function validity range = Horizontal/vertical valid range: factor 1 to 5
- Some JIS213 Kanji (JISX213) characters have values between U+10000 to U+10FFFF.

Both UTF-8 and UTF-16 encodings are supported. Characters are encoded as surrogate pairs in UTF-16, and as a 4 byte code in UTF-8. Some encoding processes use CESU-8, which converts a surrogate pair to UTF-8.

[Notes]

- With the highlighting function the character width enlarges proportional with the expansion factor.
- Using the highlighting function, depending on the type of font, characters become squeezed.
- When the Kanji mode setting is [Japan, Compatible Kanji] or [China, Simplified Chinese (GB18030)] or [China, Traditional Chinese (BIG5)] or [Korean (KSX1001)], it will be a command error.

[Valid Commands]

Print position	<V>	<H>								
Modification	<P>	<L>	<%>	<&>	</>	<0>	<WD>			

[ESC+K4] 32 x 32 dots Kanji in horizontal line

Hexadecimal code	ESC	K4	Parameter
	<1B> ₁₆	<4B> ₁₆ <34> ₁₆	an...n
Initial value	Nil		

Valid range and term of command	When the power is OFF	The set parameter is not maintained.
	Valid range within items	The set parameter becomes invalid.
	Valid range between items	The set parameter becomes invalid.

[Function]

Specifying 32 x 32 (width x height) dots horizontal written Kanji character print.

[Format]

<K4>an...n

- Parameter

a [Kanji selection mode]

H: HEX characters

B: Binary code

I: HEX characters, smoothing function

C: Binary code, smoothing function

J: HEX characters, highlighting function

D: Binary code, highlighting function

K: HEX characters, smoothing and highlighting function

E: Binary code, smoothing and highlighting function

n [Data] = Print data. For the available character codes, refer to Kanji code (ESC+KC) command.

[Coding example 1]

Shift JIS HEX characters, Horizontal enlargement ratio: 3, Vertical enlargement ratio: 5

<A>

<KC>1

<V>100<H>200<P>2<L>0305

<K4>H81698A94816A83548367815B

<Q>2

<Z>

[Coding example 2]

JIS binary code, Horizontal enlargement ratio: 2, Vertical enlargement ratio: 3

<A>

<KC>0

<V>100<H>100<P>2<L>0203

<K4>B!J3T!K%5%H!<

<Q>2

<Z>

[Supplementary Explanation]

- HEX characters = Kanji Code 4 bytes ASCII / 1 Kanji character (Ex.Shift JIS code)
- Binary code = Kanji Code 2 bytes / 1 Kanji character (Ex.Shift JIS code)
- Smoothing function validity range = Horizontal/vertical valid range: factor 3 to 12

- Highlighting function validity range = Horizontal/vertical valid range: factor 1 to 5
- Some JIS213 Kanji (JISX213) characters have values between U+10000 to U+10FFFF.

Both UTF-8 and UTF-16 encodings are supported. Characters are encoded as surrogate pairs in UTF-16, and as a 4 byte code in UTF-8. Some encoding processes use CESU-8, which converts a surrogate pair to UTF-8.

[Notes]

- With the highlighting function the character width enlarges proportional with the expansion factor.
- Using the highlighting function, depending on the type of font, characters become squeezed.
- When the Kanji mode setting is [Japan, Compatible Kanji] or [China, Simplified Chinese (GB18030)] or [China, Traditional Chinese (BIG5)] or [Korean (KSX1001)], it will be a command error.

[Valid Commands]

Print position	<V>	<H>								
Modification	<P>	<L>	<%>	<&>	</>	<0>	<WD>			

[ESC+K5] 40 x 40 dots Kanji in horizontal line

Hexadecimal code	ESC	K5	Parameter
	<1B> ₁₆	<4B> ₁₆ <35> ₁₆	an...n
Initial value	Nil		

Valid range and term of command	When the power is OFF	The set parameter is not maintained.
	Valid range within items	The set parameter becomes invalid.
	Valid range between items	The set parameter becomes invalid.

[Function]

Specifying 40 x 40 (width x height) dots horizontal written Kanji character print.

[Format]

<K5>an...n

- Parameter

a [Kanji selection mode]

H: HEX characters

B: Binary code

I: HEX characters, smoothing function

C: Binary code, smoothing function

J: HEX characters, highlighting function

D: Binary code, highlighting function

K: HEX characters, smoothing and highlighting function

E: Binary code, smoothing and highlighting function

n [Data] = Print data. For the available character codes, refer to Kanji code (ESC+KC) command.

[Coding example 1]

Shift JIS HEX characters, Horizontal enlargement ratio: 3, Vertical enlargement ratio: 5

<A>

<KC>1

<V>100<H>200<P>2<L>0305

<K5>H81698A94816A83548367815B

<Q>2

<Z>

[Coding example 2]

JIS binary code, Horizontal enlargement ratio: 2, Vertical enlargement ratio: 3

<A>

<KC>0

<V>100<H>100<P>2<L>0203

<K5>B!J3T!K%5%H!<

<Q>2

<Z>

[Supplementary Explanation]

- HEX characters = Kanji Code 4 bytes ASCII / 1 Kanji character (Ex.Shift JIS code)
- Binary code = Kanji Code 2 bytes / 1 Kanji character (Ex.Shift JIS code)
- Smoothing function validity range = Horizontal/vertical valid range: factor 3 to 12

- Highlighting function validity range = Horizontal/vertical valid range: factor 1 to 5
- Some JIS213 Kanji (JISX213) characters have values between U+10000 to U+10FFFF.

Both UTF-8 and UTF-16 encodings are supported. Characters are encoded as surrogate pairs in UTF-16, and as a 4 byte code in UTF-8. Some encoding processes use CESU-8, which converts a surrogate pair to UTF-8.

[Notes]

- With the highlighting function the character width enlarges proportional with the expansion factor.
- Using the highlighting function, depending on the type of font, characters become squeezed.
- When the Kanji mode setting is [Japan, Compatible Kanji] or [China, Simplified Chinese (GB18030)] or [China, Traditional Chinese (BIG5)] or [Korean (KSX1001)], it will be a command error.

[Valid Commands]

Print position	<V>	<H>								
Modification	<P>	<L>	<%>	<&>	</>	<0>	<WD>			

[ESC+K8] 16 x 16 dots Kanji in horizontal line with 1-byte character

Hexadecimal code	ESC	K8	Parameter
	<1B> ₁₆	<4B> ₁₆ <38> ₁₆	an...n
Initial value	Nil		
Valid range and term of command	When the power is OFF	The set parameter is not maintained.	
	Valid range within items	The set parameter becomes invalid.	
	Valid range between items	The set parameter becomes invalid.	

[Function]

Specifying 16 x 16 (width x height) dots horizontal written Kanji character print and W8 x H16 dots half size character in horizontal line.

[Format]

<K8>an...n

- Parameter
 - a [Kanji selection mode]
 - H: HEX characters
 - B: Binary code
 - I: HEX characters, smoothing function
 - C: Binary code, smoothing function
 - J: HEX characters, highlighting function
 - D: Binary code, highlighting function
 - K: HEX characters, smoothing and highlighting function
 - E: Binary code, smoothing and highlighting function
 - n [Data] = Print data. For the available character codes, refer to Kanji code (ESC+KC) command.

[Coding example]

Shift JIS HEX characters, Data: 株式会社

```
<A>
<KC>1
<V>100<H>200<P>2<L>0305
<K8>H8A948EAE89EF8ED0BBC4B0
<Q>2
<Z>
```

[Supplementary Explanation]

- HEX characters = Kanji Code 4 bytes ASCII / 1 Kanji character (Ex.Shift JIS code)
- Binary code = Kanji Code 2 bytes / 1 Kanji character (Ex.Shift JIS code)
- Smoothing function validity range = Horizontal/vertical valid range: factor 3 to 12
- Highlighting function validity range = Horizontal/vertical valid range: factor 1 to 5
- Some JIS213 Kanji (JISX213) characters have values between U+10000 to U+10FFFF.

Both UTF-8 and UTF-16 encodings are supported. Characters are encoded as surrogate pairs in UTF-16, and as a 4 byte code in UTF-8. Some encoding processes use CESU-8, which converts a surrogate pair to UTF-8.

[Notes]

- With the highlighting function the character width enlarges proportional with the expansion factor.
- Using the highlighting function, depending on the type of font, characters become squeezed.
- This command is not available for JIS code print data.
- For the half size character (1-byte character code), printing will be performed in W8 x H16 dots.
- For the full size character (2-byte character code), printing will be performed in W16 x H16 dots.
- When the Kanji mode setting is [China, Traditional Chinese (BIG5)], it will be a command error.

[Valid Commands]

Print position	<V>	<H>								
Modification	<P>	<L>	<%>	<&>	</>	<0>	<WD>			

[ESC+K9] 24 x 24 dots Kanji in horizontal line with 1-byte character

Hexadecimal code	ESC	K9	Parameter
	<1B> ₁₆	<4B> ₁₆ <39> ₁₆	an...n
Initial value	Nil		
Valid range and term of command	When the power is OFF	The set parameter is not maintained.	
	Valid range within items	The set parameter becomes invalid.	
	Valid range between items	The set parameter becomes invalid.	

[Function]

Specifying 24 x 24 (width x height) dots horizontal written kanji character print and W12 x H24 dots half size character in horizontal line.

[Format]

<K9>an...n

- Parameter
 - a [Chinese selection mode]
 - H: HEX characters
 - B: Binary code
 - I: HEX characters, smoothing function
 - C: Binary code, smoothing function
 - J: HEX characters, highlighting function
 - D: Binary code, highlighting function
 - K: HEX characters, smoothing and highlighting function
 - E: Binary code, smoothing and highlighting function
 - n [Data] = Print data. For the available character codes, refer to Kanji code (ESC+KC) command.

[Coding example]

Shift JIS HEX characters, Data: 株式会社

```
<A>
<KC>1
<V>100<H>200<P>2<L>0305
<K9>H8A948EAE89EF8ED0BBC4B0
<Q>2
<Z>
```

[Supplementary Explanation]

- HEX characters = Kanji Code 4 bytes ASCII / 1 Kanji character (Ex.Shift JIS code)
- Binary code = Kanji Code 2 bytes / 1 Kanji character (Ex.Shift JIS code)
- Smoothing function validity range = Horizontal/vertical valid range: factor 3 to 12
- Highlighting function validity range = Horizontal/vertical valid range: factor 1 to 5
- Some JIS213 Kanji (JISX213) characters have values between U+10000 to U+10FFFF.

Both UTF-8 and UTF-16 encodings are supported. Characters are encoded as surrogate pairs in UTF-16, and as a 4 byte code in UTF-8. Some encoding processes use CESU-8, which converts a surrogate pair to UTF-8.

[Notes]

- With the highlighting function the character width enlarges proportional with the expansion factor.
- Using the highlighting function, depending on the type of font, characters become squeezed.
- This command is not available for JIS code print data.
- For the half size character (1-byte character code), printing will be performed in W12 x H24 dots.
- For the full size character (2-byte character code), printing will be performed in W24 x H24 dots.

[Valid Commands]

Print position	<V>	<H>								
Modification	<P>	<L>	<%>	<&>	</>	<0>	<WD>			

[ESC+KA] 22 x 22 dots Kanji in horizontal line with 1-byte character

Hexadecimal code	ESC	KA	Parameter
	<1B> ₁₆	<4B> ₁₆ <41> ₁₆	an...n
Initial value	Nil		
Valid range and term of command	When the power is OFF	The set parameter is not maintained.	
	Valid range within items	The set parameter becomes invalid.	
	Valid range between items	The set parameter becomes invalid.	

[Function]

Specifying 22 x 22 (width x height) dots horizontal written kanji character print and W11 x H22 dots half size character in horizontal line.

[Format]

<KA>an...n

- Parameter
 - a [Chinese selection mode]
 - H: HEX characters
 - B: Binary code
 - I: HEX characters, smoothing function
 - C: Binary code, smoothing function
 - J: HEX characters, highlighting function
 - D: Binary code, highlighting function
 - K: HEX characters, smoothing and highlighting function
 - E: Binary code, smoothing and highlighting function
 - n [Data] = Print data. For the available character codes, refer to Kanji code (ESC+KC) command.

[Coding example]

Shift JIS HEX characters, Data: 株式会社

```

<A>
<KC>1
<V>100<H>200<P>2<L>0305
<CC>0
<KA>H8A948EAE89EF8ED0BBC4B0
<Q>2
<Z>
  
```

[Supplementary Explanation]

- HEX characters = Kanji Code 4 bytes ASCII / 1 Kanji character (Ex.Shift JIS code)
- Binary code = Kanji Code 2 bytes / 1 Kanji character (Ex.Shift JIS code)
- Smoothing function validity range = Horizontal/vertical valid range: factor 3 to 12
- Highlighting function validity range = Horizontal/vertical valid range: factor 1 to 5
- Some JIS213 Kanji (JISX213) characters have values between U+10000 to U+10FFFF.

Both UTF-8 and UTF-16 encodings are supported. Characters are encoded as surrogate pairs in UTF-16, and as a 4 byte code in UTF-8. Some encoding processes use CESU-8, which converts a surrogate pair to UTF-8.

[Notes]

- With the highlighting function the character width enlarges proportional with the expansion factor.
- Using the highlighting function, depending on the type of font, characters become squeezed.
- This command is not available for JIS code print data.
- For the half size character (1-byte character code), printing will be performed in W11 x H22 dots.
- For the full size character (2-byte character code), printing will be performed in W22 x H22 dots.
- When the Kanji mode setting is [Japan, Compatible Kanji] or [China, Simplified Chinese (GB18030)] or [China, Traditional Chinese (BIG5)] or [Korean (KSX1001)], it will be a command error.

[Valid Commands]

Print position	<V>	<H>								
Modification	<P>	<L>	<%>	<&>	</>	<0>	<WD>			

[ESC+KB] 32 x 32 dots Kanji in horizontal line with 1-byte character

Hexadecimal code	ESC	KB	Parameter
	<1B> ₁₆	<4B> ₁₆ <42> ₁₆	an...n
Initial value	Nil		
Valid range and term of command	When the power is OFF	The set parameter is not maintained.	
	Valid range within items	The set parameter becomes invalid.	
	Valid range between items	The set parameter becomes invalid.	

[Function]

Specifying 32 x 32 (width x height) dots horizontal written kanji character print and W16 x H32 dots half size character in horizontal line.

[Format]

<KB>an...n

- Parameter
 - a [Chinese selection mode]
 - H: HEX characters
 - B: Binary code
 - I: HEX characters, smoothing function
 - C: Binary code, smoothing function
 - J: HEX characters, highlighting function
 - D: Binary code, highlighting function
 - K: HEX characters, smoothing and highlighting function
 - E: Binary code, smoothing and highlighting function
 - n [Data] = Print data. For the available character codes, refer to Kanji code (ESC+KC) command.

[Coding example]

Shift JIS HEX characters, Data: 株式会社

```
<A>
<KC>1
<V>100<H>200<P>2<L>0305
<KB>H8A948EAE89EF8ED0BBC4B0
<Q>2
<Z>
```

[Supplementary Explanation]

- HEX characters = Kanji Code 4 bytes ASCII / 1 Kanji character (Ex.Shift JIS code)
- Binary code = kanji Code 2 bytes / 1 Kanji character (Ex.Shift JIS code)
- Smoothing function validity range = Horizontal/vertical valid range: factor 3 to 12
- Highlighting function validity range = Horizontal/vertical valid range: factor 1 to 5
- Some JIS213 Kanji (JISX213) characters have values between U+10000 to U+10FFFF.

Both UTF-8 and UTF-16 encodings are supported. Characters are encoded as surrogate pairs in UTF-16, and as a 4 byte code in UTF-8. Some encoding processes use CESU-8, which converts a surrogate pair to UTF-8.

[Notes]

- With the highlighting function the character width enlarges proportional with the expansion factor.
- Using the highlighting function, depending on the type of font, characters become squeezed.
- For the half size character (1-byte character code), printing will be performed in W16 x H32 dots.
- For the full size character (2-byte character code), printing will be performed in W32 x H32 dots.
- This command is not available for JIS code print data.
- When the Kanji mode setting is [Japan, Compatible Kanji] or [China, Simplified Chinese (GB18030)] or [China, Traditional Chinese (BIG5)] or [Korean (KSX1001)], it will be a command error.

[Valid Commands]

Print position	<V>	<H>								
Modification	<P>	<L>	<%>	<&>	</>	<0>	<WD>			

[ESC+KD] 40 x 40 dots Kanji in horizontal line with 1-byte character

Hexadecimal code	ESC	KD	Parameter
	<1B> ₁₆	<4B> ₁₆ <44> ₁₆	an...n
Initial value	Nil		
Valid range and term of command	When the power is OFF	The set parameter is not maintained.	
	Valid range within items	The set parameter becomes invalid.	
	Valid range between items	The set parameter becomes invalid.	

[Function]

Specifying 40 x 40 (width x height) dots horizontal written kanji character print and W20 x H40 dots half size character in horizontal line.

[Format]

<KD>an...n

- Parameter
 - a [Chinese selection mode]
 - H: HEX characters
 - B: Binary code
 - I: HEX characters, smoothing function
 - C: Binary code, smoothing function
 - J: HEX characters, highlighting function
 - D: Binary code, highlighting function
 - K: HEX characters, smoothing and highlighting function
 - E: Binary code, smoothing and highlighting function
 - n [Data] = Print data. For the available character codes, refer to Kanji code (ESC+KC) command.

[Coding example]

Shift JIS HEX characters, Data: 株式会社

```
<A>
<KC>1
<V>100<H>200<P>2<L>0305
<KD>H8A948EAE89EF8ED0BBC4B0
<Q>2
<Z>
```

[Supplementary Explanation]

- HEX characters = Kanji Code 4 bytes ASCII / 1 Kanji character (Ex.Shift JIS code)
- Binary code = kanji Code 2 bytes / 1 Kanji character (Ex.Shift JIS code)
- Smoothing function validity range = Horizontal/vertical valid range: factor 3 to 12
- Highlighting function validity range = Horizontal/vertical valid range: factor 1 to 5
- Some JIS213 Kanji (JISX213) characters have values between U+10000 to U+10FFFF.

Both UTF-8 and UTF-16 encodings are supported. Characters are encoded as surrogate pairs in UTF-16, and as a 4 byte code in UTF-8. Some encoding processes use CESU-8, which converts a surrogate pair to UTF-8.

[Notes]

- With the highlighting function the character width enlarges proportional with the expansion factor.
- Using the highlighting function, depending on the type of font, characters become squeezed.
- For the half size character (1-byte character code), printing will be performed in W20 x H40 dots.
- For the full size character (2-byte character code), printing will be performed in W40 x H40 dots.
- This command is not available for JIS code print data.
- When the Kanji mode setting is [Japan, Compatible Kanji] or [China, Simplified Chinese (GB18030)] or [China, Traditional Chinese (BIG5)] or [Korean (KSX1001)], it will be a command error.

[Valid Commands]

Print position	<V>	<H>								
Modification	<P>	<L>	<%>	<&>	</>	<0>	<WD>			

[ESC+k1] 16 x 16 dots Kanji in vertical line

Hexadecimal code	ESC	k1	Parameter
	<1B> ₁₆	<6B> ₁₆ <31> ₁₆	an...n
Initial value	Nil		

Valid range and term of command	When the power is OFF	The set parameter is not maintained.
	Valid range within items	The set parameter becomes invalid.
	Valid range between items	The set parameter becomes invalid.

[Function]

Specifying 16 x 16 (width x height) dots vertical written Kanji character print.

[Format]

<k1>an...n

- Parameter

a [Kanji selection mode]

H: HEX characters

B: Binary code

I: HEX characters, smoothing function

C: Binary code, smoothing function

J: HEX characters, highlighting function

D: Binary code, highlighting function

K: HEX characters, smoothing and highlighting function

E: Binary code, smoothing and highlighting function

n [Data] = Print data. For the available character codes, refer to Kanji code (ESC+KC) command.

[Coding example 1]

Shift JIS HEX characters, Horizontal enlargement ratio: 3, Vertical enlargement ratio: 5

<A>

<KC>1

<V>100<H>200<P>2<L>0305

<k1>H81698A94816A83548367815B

<Q>2

<Z>

[Coding example 2]

JIS binary code, Horizontal magnification: 2, Vertical magnification: 3

<A>

<KC>0

<V>100<H>100<P>2<L>0203

<k1>B!J3T!K%5%H!<

<Q>2

<Z>

[Supplementary Explanation]

- HEX characters = Kanji Code 4 bytes ASCII / 1 Kanji character (Ex.Shift JIS code)
- Binary code = Kanji Code 2 bytes / 1 Kanji character (Ex.Shift JIS code)
- Smoothing function validity range = Horizontal/vertical valid range: factor 3 to 12
- Highlighting function validity range = Horizontal/vertical valid range: factor 1 to 5
- Print result of two bytes under bar "_" is vertical line (excluding when the kanji mode is [Japan, Compatible kanji]).
- When the language setting of the printer is Japanese or Simplified Chinese or Traditional Chinese or Korean, printing follows the language setting.
- Some JIS213 Kanji (JISX213) characters have values between U+10000 to U+10FFFF.

Both UTF-8 and UTF-16 encodings are supported. Characters are encoded as surrogate pairs in UTF-16, and as a 4 byte code in UTF-8. Some encoding processes use CESU-8, which converts a surrogate pair to UTF-8.

[Notes]

- With the highlighting function the character width enlarges proportional with the expansion factor.
- Using the highlighting function, depending on the type of font, characters become squeezed.
- When the Kanji mode setting is [China, Traditional Chinese (BIG5)], it will be a command error.

[Valid Commands]

Print position	<V>	<H>								
Modification	<P>	<L>	<%>	<&>	</>	<0>	<WD>			

[ESC+k2] 24 x 24 dots Kanji in vertical line

Hexadecimal code	ESC	k2	Parameter
	<1B> ₁₆	<6B> ₁₆ <32> ₁₆	an...n
Initial value	Nil		

Valid range and term of command	When the power is OFF	The set parameter is not maintained.
	Valid range within items	The set parameter becomes invalid.
	Valid range between items	The set parameter becomes invalid.

[Function]

Specifying 24 x 24 (width x height) dots vertical written Kanji character print.

[Format]

<k2>an...n

- Parameter

a [Kanji selection mode]

H: HEX characters

B: Binary code

I: HEX characters, smoothing function

C: Binary code, smoothing function

J: HEX characters, highlighting function

D: Binary code, highlighting function

K: HEX characters, smoothing and highlighting function

E: Binary code, smoothing and highlighting function

n [Data] = Print data. For the available character codes, refer to Kanji code (ESC+KC) command.

[Coding example 1]

Shift JIS HEX characters, Horizontal enlargement ratio: 3, Vertical enlargement ratio: 5

<A>

<KC>1

<V>100<H>200<P>2<L>0305

<k2>H81698A94816A83548367815B

<Q>2

<Z>

[Coding example 2]

JIS binary code, Horizontal magnification: 2, Vertical magnification: 3

<A>

<KC>0

<V>100<H>100<P>2<L>0203

<k2>B!J3T!K%5%H!<

<Q>2

<Z>

[Supplementary Explanation]

- HEX characters = Chinese Code 4 bytes ASCII / 1 Chinese character (Ex.Shift JIS code)
- Binary code = Chinese Code 2 bytes / 1 Chinese character (Ex.Shift JIS code)
- Smoothing function validity range = Horizontal/vertical valid range: factor 3 to 12
- Highlighting function validity range = Horizontal/vertical valid range: factor 1 to 5
- Print result of two bytes under bar "_" is vertical line (excluding when the kanji mode is [Japan, Compatible kanji]).
- When the language setting of the printer is Japanese or Simplified Chinese or Traditional Chinese or Korean, printing follows the language setting.
- Some JIS213 Kanji (JISX213) characters have values between U+10000 to U+10FFFF.

Both UTF-8 and UTF-16 encodings are supported. Characters are encoded as surrogate pairs in UTF-16, and as a 4 byte code in UTF-8. Some encoding processes use CESU-8, which converts a surrogate pair to UTF-8.

[Notes]

- With the highlighting function the character width enlarges proportional with the expansion factor.
- Using the highlighting function, depending on the type of font, characters become squeezed.

[Valid Commands]

Print position	<V>	<H>								
Modification	<P>	<L>	<%>	<&>	</>	<0>	<WD>			

[ESC+k3] 22 x 22 dots Kanji in vertical line

Hexadecimal code	ESC	k3	Parameter
	<1B> ₁₆	<6B> ₁₆ <33> ₁₆	an...n
Initial value	Nil		

Valid range and term of command	When the power is OFF	The set parameter is not maintained.
	Valid range within items	The set parameter becomes invalid.
	Valid range between items	The set parameter becomes invalid.

[Function]

Specifying 22 x 22 (width x height) dots vertical written Kanji character print.

[Format]

<k3>an...n

- Parameter

a [Kanji selection mode]

H: HEX characters

B: Binary code

I: HEX characters, smoothing function

C: Binary code, smoothing function

J: HEX characters, highlighting function

D: Binary code, highlighting function

K: HEX characters, smoothing and highlighting function

E: Binary code, smoothing and highlighting function

n [Data] = Print data. For the available character codes, refer to Kanji code (ESC+KC) command.

[Coding example 1]

Shift JIS HEX characters, Horizontal enlargement ratio: 3, Vertical enlargement ratio: 5

<A>

<KC>1

<V>100<H>200<P>2<L>0305

<k3>H81698A94816A83548367815B

<Q>2

<Z>

[Coding example 2]

JIS binary code, Horizontal magnification: 2, Vertical magnification: 3

<A>

<KC>0

<V>100<H>100<P>2<L>0203

<k3>B!J3T!K%5%H!<

<Q>2

<Z>

[Supplementary Explanation]

- HEX characters = Chinese Code 4 bytes ASCII / 1 Chinese character (Ex.Shift JIS code)
- Binary code = Chinese Code 2 bytes / 1 Chinese character (Ex.Shift JIS code)
- Smoothing function validity range = Horizontal/vertical valid range: factor 3 to 12

- Highlighting function validity range = Horizontal/vertical valid range: factor 1 to 5
- Print result of two bytes under bar "_" is vertical line.
- Some JIS213 Kanji (JISX213) characters have values between U+10000 to U+10FFFF.

Both UTF-8 and UTF-16 encodings are supported. Characters are encoded as surrogate pairs in UTF-16, and as a 4 byte code in UTF-8. Some encoding processes use CESU-8, which converts a surrogate pair to UTF-8.

[Notes]

- With the highlighting function the character width enlarges proportional with the expansion factor.
- Using the highlighting function, depending on the type of font, characters become squeezed.
- When the Kanji mode setting is [Japan, Compatible Kanji] or [China, Simplified Chinese (GB18030)] or [China, Traditional Chinese (BIG5)] or [Korean (KSX1001)], it will be a command error.

[Valid Commands]

Print position	<V>	<H>								
Modification	<P>	<L>	<%>	<&>	</>	<0>	<WD>			

[ESC+k4] 32 x 32 dots Kanji in vertical line

Hexadecimal code	ESC	k4	Parameter
	<1B> ₁₆	<6B> ₁₆ <34> ₁₆	an...n
Initial value	Nil		

Valid range and term of command	When the power is OFF	The set parameter is not maintained.
	Valid range within items	The set parameter becomes invalid.
	Valid range between items	The set parameter becomes invalid.

[Function]

Specifying 32 x 32 (width x height) dots vertical written Kanji character print.

[Format]

<k4>an...n

- Parameter

a [Kanji selection mode]

H: HEX characters

B: Binary code

I: HEX characters, smoothing function

C: Binary code, smoothing function

J: HEX characters, highlighting function

D: Binary code, highlighting function

K: HEX characters, smoothing and highlighting function

E: Binary code, smoothing and highlighting function

n [Data] = Print data. For the available character codes, refer to Kanji code (ESC+KC) command.

[Coding example 1]

Shift JIS HEX characters, Horizontal enlargement ratio: 3, Vertical enlargement ratio: 5

<A>

<KC>1

<V>100<H>200<P>2<L>0305

<k4>H81698A94816A83548367815B

<Q>2

<Z>

[Coding example 2]

JIS binary code, Horizontal magnification: 2, Vertical magnification: 3

<A>

<KC>0

<V>100<H>100<P>2<L>0203

<k4>B!J3T!K%5%H!<

<Q>2

<Z>

[Supplementary Explanation]

- HEX characters = Chinese Code 4 bytes ASCII / 1 Chinese character (Ex.Shift JIS code)
- Binary code = Chinese Code 2 bytes / 1 Chinese character (Ex.Shift JIS code)
- Smoothing function validity range = Horizontal/vertical valid range: factor 3 to 12

- Highlighting function validity range = Horizontal/vertical valid range: factor 1 to 5
- Print result of two bytes under bar "_" is vertical line.
- Some JIS213 Kanji (JISX213) characters have values between U+10000 to U+10FFFF.

Both UTF-8 and UTF-16 encodings are supported. Characters are encoded as surrogate pairs in UTF-16, and as a 4 byte code in UTF-8. Some encoding processes use CESU-8, which converts a surrogate pair to UTF-8.

[Notes]

- With the highlighting function the character width enlarges proportional with the expansion factor.
- Using the highlighting function, depending on the type of font, characters become squeezed.
- When the Kanji mode setting is [Japan, Compatible Kanji] or [China, Simplified Chinese (GB18030)] or [China, Traditional Chinese (BIG5)] or [Korean (KSX1001)], it will be a command error.

[Valid Commands]

Print position	<V>	<H>								
Modification	<P>	<L>	<%>	<&>	</>	<0>	<WD>			

[ESC+k5] 40 x 40 dots Kanji in vertical line

Hexadecimal code	ESC	k5	Parameter
	<1B> ₁₆	<6B> ₁₆ <35> ₁₆	an...n
Initial value	Nil		

Valid range and term of command	When the power is OFF	The set parameter is not maintained.
	Valid range within items	The set parameter becomes invalid.
	Valid range between items	The set parameter becomes invalid.

[Function]

Specifying 40 x 40 (width x height) dots vertical written Kanji character print.

[Format]

<k5>an...n

- Parameter

a [Kanji selection mode]

H: HEX characters

B: Binary code

I: HEX characters, smoothing function

C: Binary code, smoothing function

J: HEX characters, highlighting function

D: Binary code, highlighting function

K: HEX characters, smoothing and highlighting function

E: Binary code, smoothing and highlighting function

n [Data] = Print data. For the available character codes, refer to Kanji code (ESC+KC) command.

[Coding example 1]

Shift JIS HEX characters, Horizontal enlargement ratio: 3, Vertical enlargement ratio: 5

<A>

<KC>1

<V>100<H>200<P>2<L>0305

<k5>H81698A94816A83548367815B

<Q>2

<Z>

[Coding example 2]

JIS binary code, Horizontal magnification: 2, Vertical magnification: 3

<A>

<KC>0

<V>100<H>100<P>2<L>0203

<k5>B!J3T!K%5%H!<

<Q>2

<Z>

[Supplementary Explanation]

- HEX characters = Chinese Code 4 bytes ASCII / 1 Chinese character (Ex.Shift JIS code)
- Binary code = Chinese Code 2 bytes / 1 Chinese character (Ex.Shift JIS code)
- Smoothing function validity range = Horizontal/vertical valid range: factor 3 to 12

- Highlighting function validity range = Horizontal/vertical valid range: factor 1 to 5
- Print result of two bytes under bar "_" is vertical line.
- Some JIS213 Kanji (JISX213) characters have values between U+10000 to U+10FFFF.

Both UTF-8 and UTF-16 encodings are supported. Characters are encoded as surrogate pairs in UTF-16, and as a 4 byte code in UTF-8. Some encoding processes use CESU-8, which converts a surrogate pair to UTF-8.

[Notes]

- With the highlighting function the character width enlarges proportional with the expansion factor.
- Using the highlighting function, depending on the type of font, characters become squeezed.
- When the Kanji mode setting is [Japan, Compatible Kanji] or [China, Simplified Chinese (GB18030)] or [China, Traditional Chinese (BIG5)] or [Korean (KSX1001)], it will be a command error.

[Valid Commands]

Print position	<V>	<H>								
Modification	<P>	<L>	<%>	<&>	</>	<0>	<WD>			

[ESC+k8] 16 x 16 dots Kanji in vertical line with 1-byte character

Hexadecimal code	ESC	k8	Parameter
	<1B> ₁₆	<6B> ₁₆ <38> ₁₆	an...n
Initial value	Nil		
Valid range and term of command	When the power is OFF	The set parameter is not maintained.	
	Valid range within items	The set parameter becomes invalid.	
	Valid range between items	The set parameter becomes invalid.	

[Function]

Specifying 16 x 16 (width x height) dots horizontal written Kanji character print and W8 x H16 dots half size character in vertical line.

[Format]

<k8>an...n

- Parameter

a [Kanji selection mode]

H: HEX characters

B: Binary code

I: HEX characters, smoothing function

C: Binary code, smoothing function

J: HEX characters, highlighting function

D: Binary code, highlighting function

K: HEX characters, smoothing and highlighting function

E: Binary code, smoothing and highlighting function

n [Data] = Print data. For the available character codes, refer to Kanji code (ESC+KC) command.

[Coding example]

Shift JIS HEX characters, Data: 株式会社

<A>

<KC>1

<V>100<H>200<P>2<L>0305

<k8>H8A948EAE89EF8ED0BBC4B0

<Q>2

<Z>

[Supplementary Explanation]

- HEX characters = Chinese Code 4 bytes ASCII / 1 Chinese character (Ex.Shift JIS code)
- Binary code = Chinese Code 2 bytes / 1 Chinese character (Ex.Shift JIS code)
- Smoothing function validity range = Horizontal/vertical valid range: factor 3 to 12
- Highlighting function validity range = Horizontal/vertical valid range: factor 1 to 5
- Print result of two bytes under bar "_" is vertical line (excluding when the kanji mode is [Japan, Compatible kanji]).
- Some JIS213 Kanji (JISX213) characters have values between U+10000 to U+10FFFF.

Both UTF-8 and UTF-16 encodings are supported. Characters are encoded as surrogate pairs in UTF-16, and as a 4 byte code in UTF-8. Some encoding processes use CESU-8, which converts a surrogate pair to UTF-8.

[Notes]

- With the highlighting function, the character width enlarges proportional with the expansion factor.
- Using the highlighting function, depending on the type of font, characters become squeezed.
- This command is not available for JIS code print data.
- For the half size character specification (1-byte character code), printing will be performed in W8 x H16 dots.
- For the full size character specification (2-byte character code), printing will be performed in W16 x H16 dots.
- When the Kanji mode setting is [China, Traditional Chinese (BIG5)], it will be a command error.

[Attention]

- When half-sized character with voiced/P-sound consonant mark is specified, each part of character appears as a single character.

e.g.) When the word "ハ" is specified, it will be written separately such as "ハ", "ハ", "ハ".



[Valid Commands]

Print position	<V>	<H>								
Modification	<P>	<L>	<%>	<&>	</>	<0>	<WD>			

[ESC+k9] 24 x 24 dots Kanji in vertical line with 1-byte character

Hexadecimal code	ESC	k9	Parameter
	<1B> ₁₆	<6B> ₁₆ <39> ₁₆	an...n
Initial value	Nil		
Valid range and term of command	When the power is OFF	The set parameter is not maintained.	
	Valid range within items	The set parameter becomes invalid.	
	Valid range between items	The set parameter becomes invalid.	

[Function]

Specifying 24 x 24 (width x height) dots horizontal written kanji character print and W12 x H24 dots half size character in vertical line.

[Format]

<k9>an...n

- Parameter

a [Kanji selection mode]

H: HEX characters

B: Binary code

I: HEX characters, smoothing function

C: Binary code, smoothing function

J: HEX characters, highlighting function

D: Binary code, highlighting function

K: HEX characters, smoothing and highlighting function

E: Binary code, smoothing and highlighting function

n [Data] = Print data. For the available character codes, refer to Kanji code (ESC+KC) command.

[Coding example]

Shift JIS HEX characters, Data: 株式会社

<A>

<KC>1

<V>100<H>200<P>2<L>0305

<k9>H8A948EAE89EF8ED0BBC4B0

<Q>2

<Z>

[Supplementary Explanation]

- HEX characters = Chinese Code 4 bytes ASCII / 1 Chinese character (Ex.Shift JIS code)
- Binary code = Chinese Code 2 bytes / 1 Chinese character (Ex.Shift JIS code)
- Smoothing function validity range = Horizontal/vertical valid range: factor 3 to 12
- Highlighting function validity range = Horizontal/vertical valid range: factor 1 to 5
- Print result of two bytes under bar "_" is vertical line (excluding when the kanji mode is [Japan, Compatible kanji]).
- Some JIS213 Kanji (JISX213) characters have values between U+10000 to U+10FFFF.

Both UTF-8 and UTF-16 encodings are supported. Characters are encoded as surrogate pairs in UTF-16, and as a 4 byte code in UTF-8. Some encoding processes use CESU-8, which converts a surrogate pair to UTF-8.

[Notes]

- With the highlighting function, the character width enlarges proportional with the expansion factor.
- Using the highlighting function, depending on the type of font, characters become squeezed.
- This command is not available for JIS code print data.
- For the half size character specification (1-byte character code), printing will be performed in W12 x H24 dots.
- For the full size character specification (2-byte character code), printing will be performed in W24 x H24 dots.

[Attention]

- When half-sized character with voiced/P-sound consonant mark is specified, each part of character appears as a single character.

e.g.) When the word "ハ" is specified, it will be written separately such as "ハ", "ハ", "ハ".

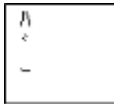

[Valid Commands]

Print position	<V>	<H>								
Modification	<P>	<L>	<%>	<&>	</>	<0>	<WD>			

[ESC+kA] 22 x 22 dots Kanji in vertical line with 1-byte character

Hexadecimal code	ESC	kA	Parameter
	<1B> ₁₆	<6B> ₁₆ <41> ₁₆	an...n
Initial value	Nil		

Valid range and term of command	When the power is OFF	The set parameter is not maintained.
	Valid range within items	The set parameter becomes invalid.
	Valid range between items	The set parameter becomes invalid.

[Function]

Specifying 22 x 22 (width x height) dots horizontal written kanji character print and W11 x H22 dots half size character in vertical line.

[Format]

<kA>an...n

- Parameter
 - a [Kanji selection mode]
 - H: HEX characters
 - B: Binary code
 - I: HEX characters, smoothing function
 - C: Binary code, smoothing function
 - J: HEX characters, highlighting function
 - D: Binary code, highlighting function
 - K: HEX characters, smoothing and highlighting function
 - E: Binary code, smoothing and highlighting function
 - n [Data] = Print data. For the available character codes, refer to Kanji code (ESC+KC) command.

[Coding example]

Shift JIS HEX characters, Data: 株式会社

```
<A>
<KC>1
<V>100<H>200<P>2<L>0305
<kA>H8A948EAE89EF8ED0BBC4B0
<Q>2
<Z>
```

[Supplementary Explanation]

- HEX characters = Chinese Code 4 bytes ASCII / 1 Chinese character (Ex.Shift JIS code)
- Binary code = Chinese Code 2 bytes / 1 Chinese character (Ex.Shift JIS code)
- Smoothing function validity range = Horizontal/vertical valid range: factor 3 to 12
- Highlighting function validity range = Horizontal/vertical valid range: factor 1 to 5
- Print result of two bytes under bar "_" is vertical line.
- Some JIS213 Kanji (JISX213) characters have values between U+10000 to U+10FFFF.

Both UTF-8 and UTF-16 encodings are supported. Characters are encoded as surrogate pairs in UTF-16, and as a 4 byte code in UTF-8. Some encoding processes use CESU-8, which converts a surrogate pair to UTF-8.

[Notes]

- With the highlighting function, the character width enlarges proportional with the expansion factor.
- Using the highlighting function, depending on the type of font, characters become squeezed.
- This command is not available for JIS code print data.
- For the half size character specification (1-byte character code), printing will be performed in W11 x H22 dots.
- For the full size character specification (2-byte character code), printing will be performed in W22 x H22 dots.
- When the Kanji mode setting is [Japan, Compatible Kanji] or [China, Simplified Chinese (GB18030)] or [China, Traditional Chinese (BIG5)] or [Korean (KSX1001)], it will be a command error.
- When the Kanji mode setting is [Japan, Compatible Kanji] or [China, Simplified Chinese (GB18030)] or [China, Traditional Chinese (BIG5)] or [Korean (KSX1001)], it will be a command error.

[Attention]

- When half-sized character with voiced/P-sound consonant mark is specified, each part of character appears as a single character.

e.g.) When the word "ハ" is specified, it will be written separately such as "ハ", "ハ", "ハ".



[Valid Commands]

Print position	<V>	<H>								
Modification	<P>	<L>	<%>	<&>	</>	<0>	<WD>			

[ESC+kB] 32 x 32 dots Kanji in vertical line with 1-byte character

Hexadecimal code	ESC	kB	Parameter
	<1B> ₁₆	<6B> ₁₆ <42> ₁₆	an...n
Initial value	Nil		
Valid range and term of command	When the power is OFF	The set parameter is not maintained.	
	Valid range within items	The set parameter becomes invalid.	
	Valid range between items	The set parameter becomes invalid.	

[Function]

Specifying 32 x 32 (width x height) dots horizontal written kanji character print and W16 x H32 dots half size character in vertical line.

[Format]

<kB>an...n

- Parameter
 - a [Kanji selection mode]
 - H: HEX characters
 - B: Binary code
 - I: HEX characters, smoothing function
 - C: Binary code, smoothing function
 - J: HEX characters, highlighting function
 - D: Binary code, highlighting function
 - K: HEX characters, smoothing and highlighting function
 - E: Binary code, smoothing and highlighting function
 - n [Data] = Print data. For the available character codes, refer to Kanji code (ESC+KC) command.

[Coding example]

Shift JIS HEX characters, Data: 株式会社

```

<A>
<KC>1
<V>100<H>200<P>2<L>0305
<CC>0
<kB>H8A948EAE89EF8ED0BBC4B0
<Q>2
<Z>
  
```

[Supplementary Explanation]

- HEX characters = Chinese Code 4 bytes ASCII / 1 Chinese character (Ex.Shift JIS code)
- Binary code = Chinese Code 2 bytes / 1 Chinese character (Ex.Shift JIS code)
- Smoothing function validity range = Horizontal/vertical valid range: factor 3 to 12
- Highlighting function validity range = Horizontal/vertical valid range: factor 1 to 5
- Print result of two bytes under bar "_" is vertical line.
- Some JIS213 Kanji (JISX213) characters have values between U+10000 to U+10FFFF.

Both UTF-8 and UTF-16 encodings are supported. Characters are encoded as surrogate pairs in UTF-16, and as a 4 byte code in UTF-8. Some encoding processes use CESU-8, which converts a surrogate pair to UTF-8.

[Notes]

- With the highlighting function, the character width enlarges proportional with the expansion factor.
- Using the highlighting function, depending on the type of font, characters become squeezed.
- This command is not available for JIS code print data.
- For the half size character specification (1-byte character code), printing will be performed in W16 x H32 dots.
- For the full size character specification (2-byte character code), printing will be performed in W32 x H32 dots.
- When the Kanji mode setting is [Japan, Compatible Kanji] or [China, Simplified Chinese (GB18030)] or [China, Traditional Chinese (BIG5)] or [Korean (KSX1001)], it will be a command error.

[Attention]

- When half-sized character with voiced/P-sound consonant mark is specified, each part of character appears as a single character.

e.g.) When the word "ハ" is specified, it will be written separately such as "ハ", "ハ", "ハ".



[Valid Commands]

Print position	<V>	<H>								
Modification	<P>	<L>	<%>	<&>	</>	<0>	<WD>			

[ESC+kD] 40 x 40 dots Kanji in vertical line with 1-byte character

Hexadecimal code	ESC	kD	Parameter
	<1B> ₁₆	<6B> ₁₆ <44> ₁₆	an...n
Initial value	Nil		
Valid range and term of command	When the power is OFF	The set parameter is not maintained.	
	Valid range within items	The set parameter becomes invalid.	
	Valid range between items	The set parameter becomes invalid.	

[Function]

Specifying 40 x 40 (width x height) dots horizontal written kanji character print and W20 x H40 dots half size character in vertical line.

[Format]

<kD>an...n

- Parameter

a [Kanji selection mode]

H: HEX characters

B: Binary code

I: HEX characters, smoothing function

C: Binary code, smoothing function

J: HEX characters, highlighting function

D: Binary code, highlighting function

K: HEX characters, smoothing and highlighting function

E: Binary code, smoothing and highlighting function

n [Data] = Print data. For the available character codes, refer to Kanji code (ESC+KC) command.

[Coding example]

Shift JIS HEX characters, Data: 株式会社

<A>

<KC>1

<V>100<H>200<P>2<L>0305

<CC>0

<kD>H8A948EAE89EF8ED0BBC4B0

<Q>2

<Z>

[Supplementary Explanation]

- HEX characters = Chinese Code 4 bytes ASCII / 1 Chinese character (Ex.Shift JIS code)
- Binary code = Chinese Code 2 bytes / 1 Chinese character (Ex.Shift JIS code)
- Smoothing function validity range = Horizontal/vertical valid range: factor 3 to 12
- Highlighting function validity range = Horizontal/vertical valid range: factor 1 to 5
- Print result of two bytes under bar "_" is vertical line.
- Some JIS213 Kanji (JISX213) characters have values between U+10000 to U+10FFFF.

Both UTF-8 and UTF-16 encodings are supported. Characters are encoded as surrogate pairs in UTF-16, and as a 4 byte code in UTF-8. Some encoding processes use CESU-8, which converts a surrogate pair to UTF-8.

[Notes]

- With the highlighting function, the character width enlarges proportional with the expansion factor.
- Using the highlighting function, depending on the type of font, characters become squeezed.
- This command is not available for JIS code print data.
- For the half size character specification (1-byte character code), printing will be performed in W20 x H40 dots.
- For the full size character specification (2-byte character code), printing will be performed in W40 x H40 dots.
- When the Kanji mode setting is [Japan, Compatible Kanji] or [China, Simplified Chinese (GB18030)] or [China, Traditional Chinese (BIG5)] or [Korean (KSX1001)], it will be a command error.

[Attention]

- When half-sized character with voiced/P-sound consonant mark is specified, each part of character appears as a single character.

e.g.) When the word "ハ" is specified, it will be written separately such as "ハ", "ハ", "ハ".



[Valid Commands]

Print position	<V>	<H>								
Modification	<P>	<L>	<%>	<&>	</>	<0>	<WD>			

[ESC+T1] 16 x 16 dots external font registration

Hexadecimal code	ESC	T1	Parameter
	<1B> ₁₆	<54> ₁₆ <31> ₁₆	abbn...n
Initial value	Nil		

Valid range and term of command	When the power is OFF	The set parameter is not maintained.
	Valid range within items	The set parameter becomes invalid.
	Valid range between items	The set parameter becomes invalid.

[Function]

Registering 16 x 16 dots external fonts.

[Format]

<T1>abbn...n

- Parameter
 - a [Registration data selection]
 - H: Registration code in HEX character
 - B: Registration code in binary code
 - b [Registration font code address]
 - Using Kanji set <KS> command to set Japanese (01,2)
 - JIS code
 - H: Up to 95 registrations from "21" to "7F" is available.
 - B: Up to 95 registrations from 21H to 7FH is available.
 - Shift JIS code
 - H: Up to 95 registrations from "40" to "9E" is available.
 - B: Up to 95 registrations from 40H to 9EH is available.
 - Unicode (UTF-16, UTF-8)
 - H: Up to 95 registrations from "00" to "5E" is available.
 - B: Up to 95 registrations from 00H to 5EH is available.
 - Using Kanji set <KS> command to set other than Japanese (3 (China Simplified Chinese), 5 (China Traditional Chinese), 6 (Korean))
 - GB18030, BIG5, KSC5601(EUC-KR) code
 - H: Up to 95 registrations from "21" to "7F" is available.
 - B: Up to 95 registrations from 21H to 7FH is available.
 - Unicode (UTF-8)
 - H: Up to 95 registrations from "00" to "5E" is available.
 - B: Up to 95 registrations from 00H to 5EH is available.

n [Registered external font data] = Data

[Coding Example 1]

Registration data in JIS HEX character

```

<A>
<KS>0
<KC>0
<CC>0
<T1>H21
00FF.....FF00
<Z>

<A>
<KS>0
<KC>0
  
```

<CC>0
<V>100<H>200<K1>H9021
<Q>2
<Z>

[Coding Example 2]

Registration data in Shift JIS binary code.

<A>
<KS>0
<KC>1
<CC>0
<T1>B<40>₁₆
<00FF.....FF00>₁₆
<Z>

<A>
<KS>0
<KC>1
<CC>0
<V>100<H>200<K1>B<90>₁₆<40>₁₆
<Q>2
<Z>

[Coding Example 3]

Registration data in Unicode binary code.

<A>
<KS>0
<KC>2
<CC>0
<T1>B<00>₁₆
<00FF.....FF00>₁₆
<Z>

<A>
<KS>0
<KC>2
<CC>0
<V>100<H>200<K1>B<E0>₁₆<00>₁₆
<Q>2
<Z>

[Coding Example 4]

Register in the user registration memory.

<A>
<KS>0
<KC>1
<CC>1
<T1>B<40>₁₆
<00FF.....FF00>₁₆
<Z>

[Supplemental explanation]

- Registering 16 x 16 dots external fonts in the internal memory or user registration memory.
- The code to specify in the registration font code address needs to match the Kanji set (<KS>) and Kanji code (<KC>).
- Overwriting registration data is available.
- The order of data registration is as follows.
- The data registered in the printer memory will be deleted at the power off. In this case, you need to register the data again.

External character file [16 x 16]

D1	D2
D3	D4
D5	D6
D31	D32

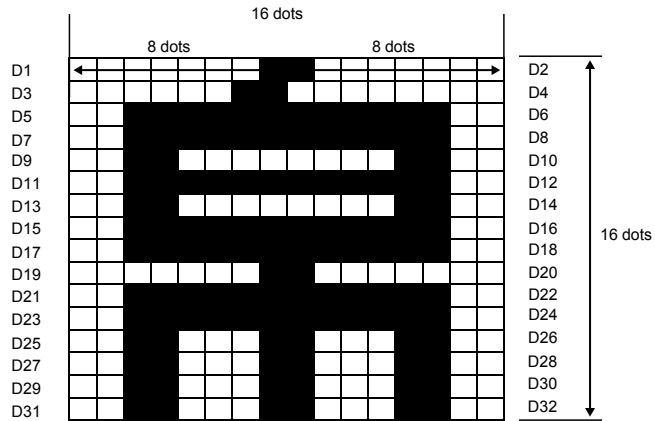

When registering the external characters described above, D1 data becomes <01>₁₆ and D2 data becomes <80>₁₆ because D1 consists of [00000001], D2 consists of [10000000]. In the same manner, D3 is <03>₁₆, D4 is <00>₁₆, D5 is <3F>₁₆, D6 is <FC>₁₆, and the external registration data will be <018003003FFC.....>₁₆ up to D32.

[Point]

- The data registered in the user registration memory will be maintained after the power is off.
 - You cannot use the internal memory in combination with the user registration memory.
 - Specify the slot to register.
- If <CC> command is not sent after the power on, the data are registered in the internal memory.

[ESC+T2] 24 x 24 dots external font registration

Hexadecimal code	ESC	T2	Parameter
	<1B> ₁₆	<54> ₁₆ <32> ₁₆	abbn...n
Initial value	Nil		

Valid range and term of command	When the power is OFF	The set parameter is not maintained.
	Valid range within items	The set parameter becomes invalid.
	Valid range between items	The set parameter becomes invalid.

[Function]

Registering 24 x 24 dots external fonts.

[Format]

<T2>abbn...n

- Parameter
 - a [Registration data selection]
 - H: Registration code in HEX character
 - B: Registration code in binary code
 - b [Registration font code address]
 - Using Kanji set <KS> command to set Japanese (01,2)
 - JIS code
 - H: Up to 95 registrations from "21" to "7F" is available.
 - B: Up to 95 registrations from 21H to 7FH is available.
 - Shift JIS code
 - H: Up to 95 registrations from "40" to "9E" is available.
 - B: Up to 95 registrations from 40H to 9EH is available.
 - Unicode (UTF-16, UTF-8)
 - H: Up to 95 registrations from "00" to "5E" is available.
 - B: Up to 95 registrations from 00H to 5EH is available.
 - Using Kanji set <KS> command to set other than Japanese (3 (China Simplified Chinese), 5 (China Traditional Chinese), 6 (Korean))
 - GB18030, BIG5, KSC5601(EUC-KR) code
 - H: Up to 95 registrations from "21" to "7F" is available.
 - B: Up to 95 registrations from 21H to 7FH is available.
 - Unicode (UTF-8)
 - H: Up to 95 registrations from "00" to "5E" is available.
 - B: Up to 95 registrations from 00H to 5EH is available.

n [Registered external font data] = Data

[Coding Example 1]

Registration data in JIS HEX character

```

<A>
<KS>0
<KC>0
<CC>0
<T2>H21
00FF.....FF00
<Z>

<A>
<KS>0
<KC>0
  
```

<CC>0
<V>100<H>200<K1>H9021
<Q>2
<Z>

[Coding Example 2]

Registration data in Shift JIS binary code.

<A>
<KS>0
<KC>1
<CC>0
<T2>B<40>₁₆
<00FF.....FF00>₁₆
<Z>

<A>
<KS>0
<KC>1
<CC>0
<V>100<H>200<K1>B<90>₁₆<40>₁₆
<Q>2
<Z>

[Coding Example 3]

Registration data in Unicode binary code.

<A>
<KS>0
<KC>2
<CC>0
<T2>B<00>₁₆
<00FF.....FF00>₁₆
<Z>

<A>
<KS>0
<KC>2
<CC>0
<V>100<H>200<K1>B<E0>₁₆<00>₁₆
<Q>2
<Z>

[Coding Example 4]

Register in the user registration memory.

<A>
<KS>0
<KC>1
<CC>1
<T2>B<40>₁₆
<00FF.....FF00>₁₆
<Z>

[Supplemental explanation]

- Registering 24 x 24dots external fonts in the internal memory or user registration memory.
- The code to specify in the registration font code address needs to match the Kanji set (<KS>) and Kanji code (<KC>).
- Overwriting registration data is available.
- The order of data output is as follows.
- The data registered in the printer memory will be deleted at the power off. In this case, you need to register the data again.

External character file [24×24]

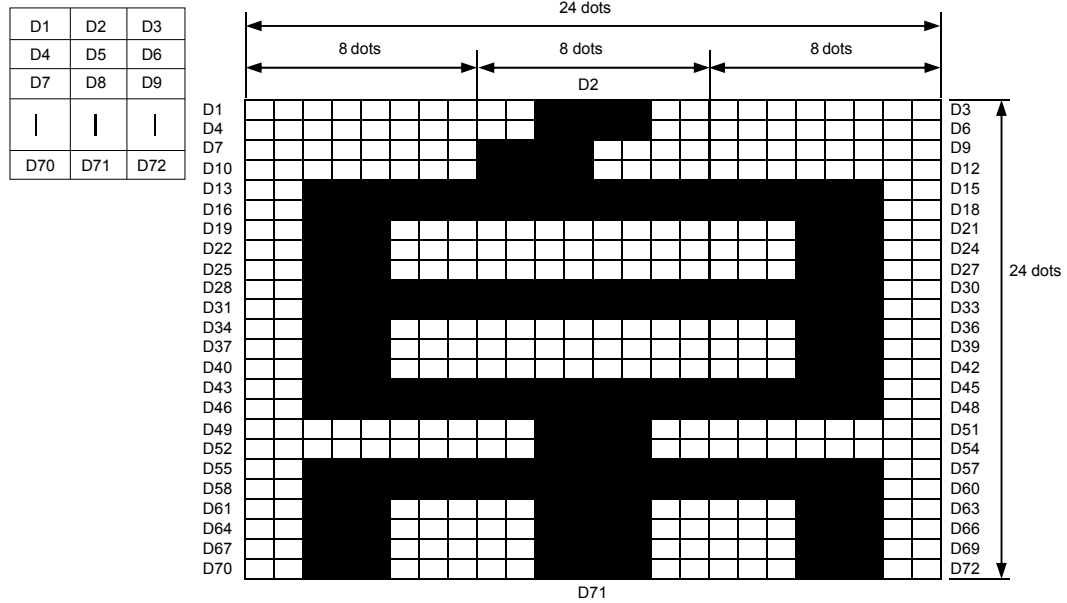

When registering the external characters described above, D1 data becomes <00>₁₆, D2 data becomes <3C>₁₆ and D3 data becomes <00>₁₆ because D1 consists of [00000000], D2 consists of [00111100] and D3 consists of [00000000]. In the same manner, D4 becomes <00>₁₆, D5 becomes <3C>₁₆ and D6 becomes <00>₁₆, and the external registration data are specified to <003C00003C00...>₁₆ and up to D72.

[Point]

- The data registered in the user registration memory will be maintained after the power is off.
 - You cannot use the internal memory in combination with the user registration memory.
 - Specify the slot to register.
- If <CC> command is not sent after the power on, the data are registered in the internal memory.

[ESC+K1(K2)] Recall horizontal writing external character

Hexadecimal code	ESC	K1(K2)	Parameter
	<1B> ₁₆	<4B> ₁₆ <31> ₁₆ (<4B> ₁₆ <32> ₁₆)	ab...b
Initial value	Nil		

Valid range and term of command	When the power is OFF	The set parameter is not maintained.
	Valid range within items	The set parameter becomes invalid.
	Valid range between items	The set parameter becomes invalid.

[Function]

Invoking horizontal external characters saved in the printer memory to print out.

[Format]

<K1>ab...b

<K2>ab...b

- Parameter

- a [Kanji selection mode]

- H: HEX character

- B: Binary code

- I: HEX character letters, smoothing function

- C: Binary code, smoothing function

- J: HEX character letters, highlight function

- D: Binary code, highlight function

- K: HEX character letters, smoothing and highlight function

- E: Binary character letters, smoothing and highlight function

- b [Registration code]

- Using Kanji set <KS> command to set Japanese (0,1,2)

- JIS code

- H, I, J, K: "9021" to "907F"

- B, C, D, E: 9021H to 907FH

- Shift JIS code

- H, I, J, K: "F040" to "F09E"

- B, C, D, E: F040H to F09EH

- Unicode (UTF-16)

- H, I, J, K: "E000" to "E05E"

- B, C, D, E: E000H to E05EH

- Unicode (UTF-8)(UTF-16 E000 to E05E expressed in UTF-8)

- H, I, J, K: "EE8080" to "EE819E"

- B, C, D, E: EE8080H to EE819EH

- Using Kanji set <KS> command to set other than Japanese

- (3 (China Simplified Chinese), 5 (China Traditional Chinese), 6 (Korean))

- GB18030, BIG5, KSC5601(EUC-KR) code

- H, I, J, K: "8021" to "807F"

- B, C, D, E: 8021H to 807FH

- Unicode (UTF-8)(UTF-16 E000 to E05E expressed in UTF-8)

- H, I, J, K: "EE8080" to "EE819E"

- B, C, D, E: EE8080H to EE819EH

[Coding example 1]

Invokes 16 x 16 dots external character, Registration data in JIS HEX character

```
<A>  
<KS>0  
<KC>0  
<T1>H21  
00FF.....FF00  
<Z>
```

```
<A>  
<KS>0  
<KC>0  
<V>100<H>200<K1>H9021  
<Q>2  
<Z>
```

[Coding example 2]

Invokes 24 x 24 dots external character, Registration data in Shift JIS binary code

```
<A>  
<KS>0  
<KC>1  
<T2>B<40>16  
<00FF.....FF00>16  
<Z>
```

```
<A>  
<KS>0  
<KC>1  
<V>100<H>200<K2>B<F0>16<40>16  
<Q>2  
<Z>
```

[Coding example 3]

Invokes 16 x 16 dots external character, Registration data in Unicode character

```
<A>  
<KS>0  
<KC>2  
<T1>H01  
00FF.....FF00  
<Z>
```

```
<A>  
<KS>0  
<KC>2  
<V>100<H>200<K1>HE001  
<Q>2  
<Z>
```

[Supplemental explanation]

- If the print out is not performed properly, register the data again.
- You cannot call the external characters registered as JIS/Shift JIS character as Unicode, and vice versa.
- Valid data of registration code vary according to the Kanji set command <KS>.

[ESC+k1(k2)] Recall vertical writing external character

Hexadecimal code	ESC	k1(k2)	Parameter
	<1B> ₁₆	<6B> ₁₆ <31> ₁₆ (<6B> ₁₆ <32> ₁₆)	ab...b
Initial value	Nil		

Valid range and term of command	When the power is OFF	The set parameter is not maintained.
	Valid range within items	The set parameter becomes invalid.
	Valid range between items	The set parameter becomes invalid.

[Function]

Invoking vertical external characters registered in the printer memory to print out.

[Format]

<k1>ab...b

<k2>ab...b

- Parameter

- a [Kanji selection mode]

- H: HEX character

- B: Binary code

- I: HEX character letters, smoothing function

- C: Binary code, smoothing function

- J: HEX character letters, highlight function

- D: Binary code, highlight function

- K: HEX character letters, smoothing and highlight function

- E: Binary character letters, smoothing and highlight function

- b [Registration code]

- Using Kanji set <KS> command to set Japanese (0,1,2)

- JIS code

- H, I, J, K: "9021" to "907F"

- B, C, D, E: 9021H to 907FH

- Shift JIS code

- H, I, J, K: "F040" to "F09E"

- B, C, D, E: F040H to F09EH

- Unicode (UTF-16)

- H, I, J, K: "E000" to "E05E"

- B, C, D, E: E000H to E05EH

- Unicode (UTF-8)(UTF-16 E000 to E05E expressed in UTF-8)

- H, I, J, K: "EE8080" to "EE819E"

- B, C, D, E: EE8080H to EE819EH

- Using Kanji set <KS> command to set other than Japanese

- (3 (China Simplified Chinese), 5 (China Traditional Chinese), 6 (Korean))

- GB18030, BIG5, KSC5601(EUC-KR) code

- H, I, J, K: "8021" to "807F"

- B, C, D, E: 8021H to 807FH

- Unicode (UTF-8)(UTF-16 E000 to E05E expressed in UTF-8)

- H, I, J, K: "EE8080" to "EE819E"

- B, C, D, E: EE8080H to EE819EH

[Coding example 1]

Invokes 16 x 16 dots external character, Registration data in JIS HEX character

```
<A>  
<KS>0  
<KC>0  
<T1>H21  
00FF.....FF00  
<Z>
```

```
<A>  
<KS>0  
<KC>0  
<V>100<H>200<k1>H9021  
<Q>2  
<Z>
```

[Coding example 2]

Invokes 24 x 24 dots external character, Registration data in Shift JIS binary code

```
<A>  
<KS>0  
<KC>1  
<T2>B<40>16  
<00FF.....FF00>16  
<Z>
```

```
<A>  
<KS>0  
<KC>1  
<V>100<H>200<k2>B<F0>16<40>16  
<Q>2  
<Z>
```

[Coding example 3]

Invokes 16 x 16 dots external character, Registration data in Unicode character

```
<A>  
<KS>0  
<KC>2  
<T1>H01  
00FF.....FF00  
<Z>
```

```
<A>  
<KS>0  
<KC>2  
<V>100<H>200<k1>HE001  
<Q>2  
<Z>
```

[Supplemental explanation]

- If the print out is not performed properly, register the data again.
- You cannot call the external characters registered as JIS/Shift JIS character as Unicode, and vice versa.
- Valid data of registration code vary according to the Kanji set command <KS>.

[ESC+PP] POP Font (Basic size 80 x 133 dots)

Hexadecimal code	ESC	PP	Parameter
	<1B> ₁₆	<50> ₁₆ <50> ₁₆	,an...n
Initial value	Nil		

Valid range and term of command	When the power is OFF	The set parameter is not maintained.
	Valid range within items	The set parameter becomes invalid.
	Valid range between items	The set parameter becomes invalid.

[Function]

Font with the basic size of: width 80 dots, height 133 dots is specified.

[Format]

<PP>,an...n

- Parameter
 - a [Smoothing] = 0 : Smoothing disabled (Fixed)
 - n [Print data] = Data

[Coding example]

```
<A>
<V>100<H>200<P>2<L>0304<PP>,01234
<Q>2
<Z>
```

[Supplementary Explanation]

- POP font allows the setting of a fixed pitch or the setting of a proportional pitch.
- Font pitch (fixed/proportional) can be selected via command or LCD settings.

[Valid Commands]

Print position	<V>	<H>								
Modification	<P>	<L>	<%>	<PS>	<PR>	<F>	<O>	<WD>		

POP font character set

Basic size is 80 x 133 dots (width x height)

	2	3	4	5	6	7	8	9	A	B	C	D	E	F
0		0												
1		1												
2		2												
3		3												
4		4												
5		5												
6		6												
7		7												
8		8												
9		9												
A														
B														
C		,		¥										
D														
E														
F														

The print sample shown above is issued with a head density of 8 dots/mm.

Barcode Command

In barcode specification, print of various barcodes, change of bar width ratio, and print of guard bar or human-readable information can be performed by the specification (B, D, BD) after ESC.

The contents may vary depending on the specification. This and next page should be read closely and followed.

Refer to the table below for the specification of B, D, and BD.

[Specification of Bar Width Ratio]

Barcode specification parameter	Barcode specification		<D>	<BD>
0	CODABAR (NW-7)	1:3	1:2	2:5
1	CODE39	1:3	1:2	2:5
2	ITF	1:3	1:2	2:5
5	Industrial 2of5	1:3	1:2	2:5
6	Matrix 2of5	1:3	1:2	2:5

(1) Bar Width Ratio

Barcode is composed of Narrow Bar, Wide Bar, Narrow Space and Wide Space. Bar width ratio is the proportion of Narrow Bar and Wide Bar.

- Barcode specification (Ratio 1:3)
This barcode is composed of Narrow Bar [1] and Wide Bar [3].
- Barcode specification (Ratio 1:2) <D>
This barcode is composed of Narrow Bar [1] and Wide Bar [2].
- Barcode specification (Ratio 2:5) <BD>
This barcode is composed of Narrow Bar [2] and Wide Bar [5].

If specifying bar width ratio for your own convenience, register the ratio with Bar Width Ratio <BT> and print labels with Print of Specified Bar Width Ratio <BW>.

(2) Width of narrow bar and height of barcode

Narrow bar indicates the narrow bar width, and bar height indicates the height of barcode.

For instance, printing narrow bar for 1 dot in head density of 8 dots/mm (203 dpi), the narrow bar width will be 0.125 mm and barcode scanner may have a reading problem. To avoid this problem, set the narrow bar to 2 dots so that the narrow bar width will be 0.25 mm and this will improve the scanner reading condition.

There is a necessity to set the narrow bar width based on the printer head density or performance of barcode scanner. In bar width ratio, [Narrow bar width] specification sets the width of bar.

e.g.)

When bar width ratio = 1:3 and narrow bar width is 3 dots, bar width ratio becomes 3:9.

Bar height is to specify the height of barcode, and proper height based on the scanner type can be set.

(3) Intercharacter gap

Intercharacter gap is the space between two adjacent barcode characters in a discrete barcode.

To specify and enable intercharacter gap, insert Character Pitch <P> right before barcode specification such as , <D> and <BD> or Print of Barcode with Registered Ratio <BW>. If not, initial value (2 dots) will be set.

Intercharacter gap is designable for the following barcodes.

- CODABAR (NW-7)
- CODE39
- Industrial 2of5
- Matrix 2of5

Intercharacter gap is the multiplier of values specified with Character Pitch <P> and narrow bar width.

e.g.)

When Character Pitch <P> is 3 and narrow bar width is 2 dots:

Intercharacter gap = 3 x 2 = 6 (dots)

(4) Designation of human readable information (HRI) and guard bar

For UPC-A and JAN/EAN 8 and 13 digits barcode, availability of human-readable information (hereinafter HRI) and guard bar can be specified.

Barcode specification parameter	Barcode specification		<D>	<BD>
3	JAN/EAN13	HRI: Nil Guard bar: Nil	HRI: Nil Guard bar: Available	HRI: Available Guard bar: Available
4	JAN/EAN8	HRI: Nil Guard bar: Nil	HRI: Nil Guard bar: Available	HRI: Available Guard bar: Available
H	UPC-A	HRI: Nil Guard bar: Nil	HRI: Nil Guard bar: Available	HRI: Available Guard bar: Available

Barcode specification parameter	Barcode specification	<BM>	<BL>
H	UPC-A	HRI: Available Guard bar: Available	HRI: Nil Guard bar: Available

(1) Specification of (No HRI, No guard bar)

If specifying , following barcode will be printed.



(2) Specification of <D> (No HRI, Guard bar available)

If specifying <D>, following barcode will be printed.

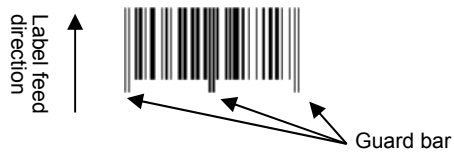

[Note]

- HRI is printable specifying <Character Type> data subsequently to <D>.
- For more information, refer to Barcode Specification (Selection of HRI) <D>~<d>.

(3) Specification of <BD> (HRI and guard bar available)

If specifying <BD>, following barcode will be printed.

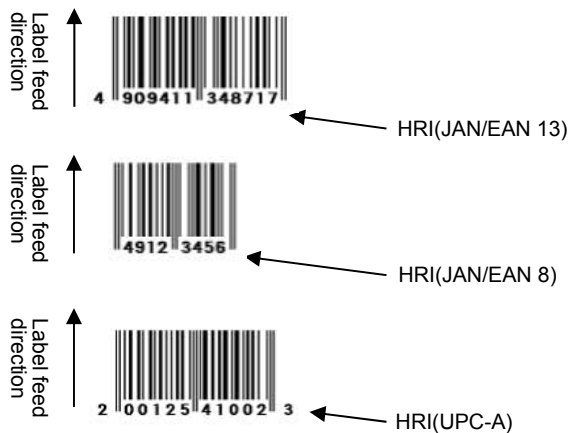

[Barcode Specification Only]

Barcode specification parameter	Barcode specification	
C	CODE93	Barcode only
E	UPC-E	Barcode only
G	CODE128	Barcode only
I	UCC/EAN 128 for standard carton ID	Barcode only

[Important]

- In this case, barcode will not have specification such as Bar Width Ratio and HRI.
- HRI will not be printed when barcode is error for barcode with HRI.

(5) Composition of check digit

Refer to the table below for check digit in each barcode.

[Composition of C/D]

Barcode specification parameter	Barcode specification	Input digit No.	Print digit number and contents
3	JAN/EAN13	12-digit	13-digit (Input data of barcode + C/D) C/D is calculated by modulus10.
		13-digit	13-digit (Input data of barcode) C/D is not checked.
4	JAN/EAN8	7-digit	8-digit (Input data of barcode + C/D) C/D is calculated by modulus10.
		8-digit	8-digit (Input data of barcode) C/D is not checked.
C	CODE93	Max. 99-digit	C/D is calculated by modulus47.
E	UPC-E	6-digit only	C/D is calculated by modulus10.
G	CODE128	-	C/D is calculated by modulus103.
H	UPC-A	11-digit only	12-digit (Input data of barcode + C/D) C/D is calculated by modulus10.
I	UCC/EAN128 for standard carton ID	17-digit only	C/D is calculated by modulus103.

Note: C/D stands for "Check Digit".

(6) Barcode Rotation Print

Print direction of barcode can be rotated. Note that when specifying Serial 1 and Serial 2 for barcode rotation, it may cause blurring due to barcode enlargement ratio.

Avoid printing of 1-dot narrow bar since 1 dot becomes 0.125 mm when head density is 8 dots/mm (203 dpi).

Parallel 1: Forward feed print

Parallel 2: Backfeed print at 180-degree rotation

Serial 1: Forward feed print at 90-degree rotation

Serial 2: Forward feed print at 270-degree rotation

* Forward feed: Prints horizontally to label feed direction

1) To print with Parallel 1 and Parallel 2, specify enlargement ratio of bar width so that narrow bar gets at least 2 dots. ("L" indicates the enlargement ratio to the bar width ratio.)

	Head density
	8 dots/mm
Bar width ratio 1:2	2L or more
Bar width ratio 1:3	2L or more
Bar width ratio 2:5	1L or more
UPC-A/EAN/JAN	2L or more

2) If printing in serial 1 or serial 2 mode, specify the bar width expansion factor so that when using a 8 dots/mm head the width of the narrow bar is at least 3 dots.

	Head density
	8 dots/mm
Bar width ratio 1:2	3L or more
Bar width ratio 1:3	3L or more
Bar width ratio 2:5	2L or more
UPC-A/EAN/JAN	3L or more

3) If printing in serial 1 or serial 2, reduce the print speed.

(7) Printing barcode exceeding the area of media size (<A1>)

When printing barcode or HRI exceeding the area of media size (<A1>), the barcode and HRI inside the media will be printed.

Example of printing UPC-A (with HRI) exceeding the area of media size

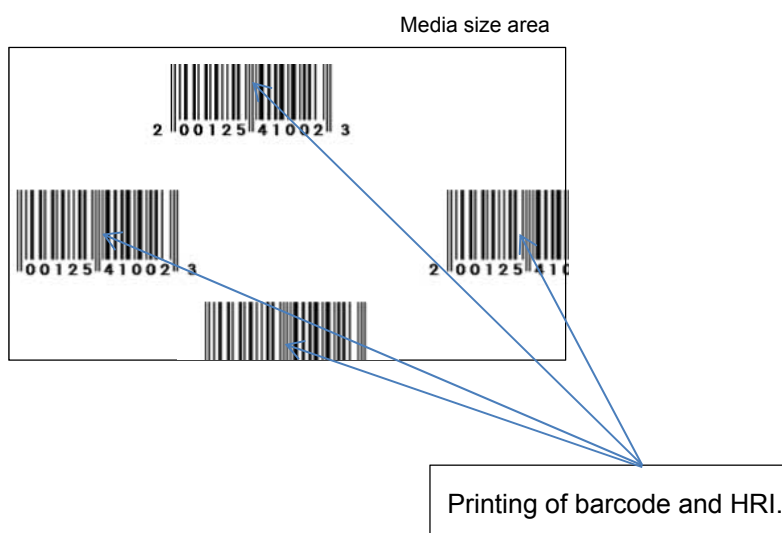

[ESC+B] Barcode (Ratio 1:3)

Hexadecimal code	ESC	B	Parameter
	<1B> ₁₆	<42> ₁₆	abbcccn...n
Initial value	Nil		

Valid range and term of command	When the power is OFF	The set parameter is not maintained.
	Valid range within items	The set parameter becomes invalid.
	Valid range between items	The set parameter becomes invalid.

[Function]

Specifies a barcode with a ratio of 1:3 between narrow bar and wide bar.

[Format]

abbcccn...n

- Parameter
 - a [Barcode type] = Refer to table below
 - b [Narrow bar width] = Valid range : 01 to 36 dots
 - c [Barcode height] = Valid range : 001 to 999 dots
 - n [Print data] = Data

Barcode types (Ratio of module composition may not be available depending on the barcode.)

a	Barcode type	Description	Ratio
0	CODABAR (NW-7)	Set print data including Start/Stop character. Start/Stop characters are [A, B, C, D, E, N, T, a, b, c, d, e, n, t, *]. Note that scan result of the characters [E, N, T, a, b, c, d, e, n, t, *] is [D, B, A, A, B, C, D, D, B, A, C]. e.g.) When barcode print data is [123], specify [A123A]. Barcode character pitch becomes enabled. For print data, refer to the CODABAR (NW-7) code table.	1:3
1	CODE39	Set print data including Start/Stop character. Start/Stop Character is [*]. e.g.) When barcode print data is [12345], specify [*12345*]. Barcode character pitch becomes enabled. For print data, refer to the CODE39 code table.	1:3
2	ITF	Specify print data in even-numbered digit. If specifying in odd-numbered digit, add "0" to the head of print data. For print data, refer to the ITF code table.	1:3
3	JAN/EAN13	This barcode has no guard bars and no human-readable characters For print data specifications, refer to table of JAN/EAN13 code.	Fixed (11,12,13 digits)
4	JAN/EAN8	This barcode has no guard bars and no human-readable characters For print data specifications, refer to table of JAN/EAN8 code.	Fixed (7,8 digits)
5	Industrial 2of5	Barcode character pitch is enabled.	1:3

a	Barcode type	Description	Ratio
		For print data specifications, refer to table of Industrial 2of5 code.	
6	Matrix 2of5	Barcode character pitch is enabled. For print data specifications, refer to table of Matrix 2of5 code.	1:3
A	MSI	Specify 13-digit number for print data. For print data specifications, refer to table of MSI code.	Fixed
C	CODE93	Refer to CODE93 <BC>.	Fixed
E	UPC-E	Specify 6-digit number for print data. For print data specifications, refer to table of UPC-E code.	Fixed
F	UPC add-on code Bookland	Refer to UPC add-on code/Bookland <BF>.	Fixed
G	CODE128	Refer to CODE128 <BG>.	Fixed
H	UPC-A	This barcode has no guard bars and no human-readable characters For print data specifications, refer to table of UPC-A code.	Fixed
I	GS1-128(UCC/EAN128)	Refer to GS1-128(UCC/EAN128)<BI>.	Fixed
P	Postnet	Refer to Postnet <BP>.	Fixed
S	USPS code	Refer to USPS code <BS>.	Fixed

[Coding Example 1]

Barcode type: CODE39 Narrow bar width: 03 Height of barcode: 120 Print data: *1234AB*



<A>
 <V>100<H>100103120*1234AB*
 <Q>2
 <Z>

[Coding Example 2]

Barcode type: JAN-8 Narrow bar width: 02 Height of barcode: 080 Print data: 4912345



<A>
 <V>100<H>1004020804912345
 <Q>2
 <Z>

[Supplementary Explanation]

- The inter-character pitch of the barcode is valid at CODABAR (NW-7), CODE39, Industrial 2of5 and Matrix 2of5.

The barcode inter-character pitch is set by specifying the character pitch <P> immediately before.

If not set, the inter-character pitch will be of the same size as a narrow space and will become multiples of a narrow bar.

Command	Ratio	Narrow space width	<P> specification	Character pitch	
				Narrow bar width is [1]	Narrow bar width is [2]
	1:3	1	None	1	2
			<P>0	1	2
			<P>1	1	2
			<P>2	2	4
			<P>3	3	6
			<P>4	4	8

- For print data of each barcode type, refer to the code tables of barcode.

[Notes]

- If the value other than valid range is set, command error will occur and barcode will not be printed.
- Barcode will be printed even if the data exceed the printing area.
- Increasing narrow bar width may exceed the printing area.
- Scanner may not read the barcode with valid character pitch when Character Pitch <P> is increased. Also, increasing the narrow bar width may cause the same type of problem. For more information, refer to the documentation of your scanner.
- For specifying the narrow bar width, consider the reading compatibility of scanner and head density beforehand.
 - 203 dpi: 2 dots or more
- Adjust Print Speed <CS> or Print Darkness <#F> if there is a problem in barcode reading.
- Matrix 2of5 will be expressed as Coop2of5/NEC2of5.
- If Start/Stop character is not included in print data at the time of CODABAR (NW-7) or CODE39 specified, barcode will be printed; however, scanner cannot read it.
- If sending the print data including check digit at the time of JAN/EAN-13 or JAN/EAN-8 specified, set the correct calculated value. Barcode will be printed even when the data includes improper check digit; however, scanner cannot read it.

[ESC+D] Barcode (Ratio 1:2)

Hexadecimal code	ESC	D	Parameter
	<1B> ₁₆	<44> ₁₆	abbcccn...n
Initial value	Nil		

Valid range and term of command	When the power is OFF	The set parameter is not maintained.
	Valid range within items	The set parameter becomes invalid.
	Valid range between items	The set parameter becomes invalid.

[Function]

Specifies a barcode with a ratio of 1:2 between narrow bar and wide bar.

[Format]

<D>abbcccn...n

- Parameter
 - a [Barcode type] = Refer to table below
 - b [Narrow bar width] = Valid range : 01 to 36 dots
 - c [Barcode height] = Valid range : 001 to 999 dots
 - n [Print data] = Data

Barcode types (Ratio of module composition may not be available depending on the barcode.)

a	Barcode type	Description	Ratio
0	CODABAR (NW-7)	Set print data including Start/Stop character. Start/Stop characters are [A, B, C, D, E, N, T, a, b, c, d, e, n, t, *]. Note that scan result of the characters [E, N, T, a, b, c, d, e, n, t, *] is [D, B, A, A, B, C, D, D, B, A, C]. e.g.) When barcode print data is [123], specify [A123A]. Barcode character pitch becomes enabled. For print data, refer to the CODABAR (NW-7) code table.	1:2
1	CODE39	Set print data including Start/Stop character. Start/Stop Character is [*]. e.g.) When barcode print data is [12345], specify [*12345*]. Barcode character pitch becomes enabled. For print data, refer to the CODE39 code table.	1:2
2	ITF	Specify print data in even-numbered digit. If specifying in odd-numbered digit, add "0" to the head of print data. For print data, refer to the ITF code table.	1:2
3	JAN/EAN13	This barcode has no guard bars and no human-readable characters For print data specifications, refer to table of JAN/EAN13 code.	Fixed
4	JAN/EAN8	This barcode has no guard bars and no human-readable characters For print data specifications, refer to table of JAN/EAN8 code.	Fixed
5	Industrial 2of5	Barcode character pitch is enabled.	1:2

a	Barcode type	Description	Ratio
		For print data specifications, refer to table of Industrial 2of5 code.	
6	Matrix 2of5	Barcode character pitch is enabled. For print data specifications, refer to table of Matrix 2of5 code.	1:2
H	UPC-A	This barcode has no human-readable characters but guard bar. For print data specifications, refer to table of UPC-A code.	Fixed

[Coding Example 1]

Barcode type: CODABAR (NW-7), Narrow bar width: 03, Height of barcode: 120, Print data: A1234A

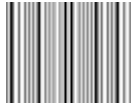

<A>
 <V>100<H>100<D>003120A1234A
 <Q>2
 <Z>

[Coding Example 2]

Barcode type: ITF, Narrow bar width: 02, Height of barcode: 080, Print data: 98002345678163



<A>
 <V>100<H>100<D>20208098002345678163
 <Q>2
 <Z>

[Coding Example 3]

Barcode type: UPC-A, Narrow bar width: 03, Height of barcode: 120, Print data: 20123948573



<A>
 <V>240<H>100<D>H0312020123948573
 <Q>2
 <Z>

[Supplementary Explanation]

- The inter-character pitch of the barcode is valid at CODABAR (NW-7), CODE39, Industrial 2of5 and Matrix 2of5.

The barcode inter-character pitch is set by specifying the character pitch <P> immediately before.

If not set, the inter-character pitch will be of the same size as a narrow space and will become multiples of a narrow bar.

e.g.)

Command	Ratio	Narrow space width	<P> specification	Gap between characters	
				Narrow bar width is [1]	Narrow bar width is [2]
<D>	1:2	1	None	1	2
			<P>0	1	2
			<P>1	1	2
			<P>2	2	4
			<P>3	3	6
			<P>4	4	8

- For print data of each barcode type, refer to the code tables of barcode.

[Notes]

- If the value other than valid range is set, command error will occur and barcode will not be printed.
- Barcode will be printed even if the data exceed the printing area.
- Increasing narrow bar width may exceed the printing area.
- Scanner may not read the barcode with valid character pitch when Character Pitch <P> is increased. Also, increasing the narrow bar width may cause the same type of problem. For more information, refer to the documentation of your scanner.
- For specifying the narrow bar width, consider the reading compatibility of scanner and head density beforehand.
 - 203 dpi: 2 dots or more
- Adjust Print Speed <CS> or Print Darkness <#F> if there is a problem in barcode reading.
- Matrix 2of5 will be expressed as Coop2of5/NEC2of5.
- If Start/Stop character is not included in print data at the time of CODABAR (NW-7) or CODE39 specified, barcode will be printed; however, scanner cannot read it.
- If sending the print data including check digit at the time of JAN/EAN-13 or JAN/EAN-8 specified, set the correct calculated value. Barcode will be printed even when the data includes improper check digit; however, scanner cannot read it.

[ESC+D] ~ [ESC+d] Barcode (with HRI)

Hexadecimal code	ESC	D~d	Parameter
	<1B> ₁₆	<44> ₁₆ ~ Character type	abbcccn...n ~ <d>n...n
Initial value	Nil		

Valid range and term of command	When the power is OFF	The set parameter is not maintained.
	Valid range within items	The set parameter becomes invalid.
	Valid range between items	The set parameter becomes invalid.

[Function]

Specifies character type of human readable interpretation (HRI) for barcode.

[Format]

<D>abbcccn...n ~ <d>n...n

- Parameter
 - a [Barcode type]
 - 3: JAN/EAN13
 - 4: JAN/EAN8
 - H: UPC-A
 - b [Narrow bar width] = Valid range: 01 to 36 dots
 - c [Height of barcode] = Valid range: 001 to 999 dots
 - n [Print data] = Barcode data
 - d [Character type]
 - OA
 - OB
 - XU
 - XS
 - XM
 - XB
 - XL
 - U
 - S
 - M
 - WB
 - WL
 - X20
 - X21
 - X22
 - X23
 - X24
- n [Print data] = HRI data

[Coding Example]

Barcode type: JAN/EAN13, Narrow bar width: 03, Barcode height: 120, Barcode data: 4902471000793, Character type: XU, HRI data: 4902471000793



<A>
<V>100<H>200<D>3031204902471000793
<XU>4902471000793
<Q>2
<Z>

[Supplementary Explanation]

- Adds HRI characters with specified font.
- When the data other than specified value is set, printing will not be performed. When barcode enlargement ratio is small and character type is large, HRI text may be overlapped with each other.
- Printer will lay out HRI properly.
- HRI for JAN/EAN8, JAN/EAN13, UPC-A will be printed properly in the conditions below.
For 203 dpi (8 dots/mm) : Appropriate Narrow bar width is [02], [03]
- HRI will not be printed when barcode is error for barcode with HRI.
- When specifying <P> and <L>, (<P>02<d>n...n, <L><d>n...n), HRI characters are not printed.

[ESC+BD] Barcode (Ratio 2:5)

Hexadecimal code	ESC	BD	Parameter
	<1B> ₁₆	<42> ₁₆ <44> ₁₆	abbcccn...n
Initial value	Nil		

Valid range and term of command	When the power is OFF	The set parameter is not maintained.
	Valid range within items	The set parameter becomes invalid.
	Valid range between items	The set parameter becomes invalid.

[Function]

Specifies a barcode with a ratio of 2:5 between narrow bar and wide bar.

[Format]

<BD>abbcccn...n

- Parameter
 - a [Barcode type] = Refer to the table below
 - b [Narrow bar width] = Valid Range : 01 to 36 dots
 - c [Height of barcode] = Valid Range : 001 to 999 dots
 - n [Print data] = data

Barcode types (Ratio of module composition may not be available depending on the barcode)

a	Barcode type	Descriptions	Ratio
0	CODABAR (NW-7)	Set print data including Start/Stop character. Start/Stop characters are [A, B, C, D, E, N, T, a, b, c, d, e, n, t, *]. Note that scan result of the characters [E, N, T, a, b, c, d, e, n, t, *] is [D, B, A, A, B, C, D, D, B, A, C]. e.g.) When barcode print data is [123], specify [A123A]. Barcode character pitch becomes enabled. For print data, refer to the CODABAR (NW-7) code table.	2:5
1	CODE39	Set print data including Start/Stop character. Start/Stop Character is [*]. e.g.) When barcode print data is [12345], specify [*12345*]. Barcode character pitch becomes enabled. For print data, refer to the CODE39 code table.	2:5
2	ITF	Specify print data in even-numbered digit. If specifying in odd-numbered digit, add "0" to the head of print data. For print data, refer to the ITF code table.	2:5
3	JAN/EAN13	This barcode has guard bars and human-readable characters. For print data specifications, refer to table of JAN/EAN13 code.	Fixed
4	JAN/EAN8	This barcode has guard bars and human-readable characters. For print data specifications, refer to table of JAN/EAN8 code.	Fixed
5	Industrial 2of5	Barcode character pitch is enabled. For print data specifications, refer to table of Industrial 2of5 code.	2:5

a	Barcode type	Descriptions	Ratio
6	Matrix 2of5	Barcode character pitch is enabled. For print data specifications, refer to table of Matrix 2of5 code.	2:5
H	UPC-A	This barcode has human-readable characters and guard bar. For print data specifications, refer to table of UPC-A code.	Fixed

[Coding Example 1]

Barcode symbology: CODABAR (NW-7), Narrow bar width: 03, Height of barcode: 120, Print data: A1234A



<A>
 <V>100<H>100<BD>003120A1234A
 <Q>2
 <Z>

[Coding Example 2]

Barcode symbology: ITF, Narrow bar width: 03, Height of barcode: 120, Print data: 98002345678163



<A>
 <V>100<H>100<BD>20212098002345678163
 <Q>2
 <Z>

[Coding Example 3]

Barcode symbology: UPC-A, Narrow bar width: 03, Height of barcode: 120, Print data: 20123948573



<A>
 <V>240<H>100<BD>H0312020123948573
 <Q>2
 <Z>

[Supplementary Explanation]

- The inter-character pitch of the barcode is valid at CODABAR (NW-7), CODE39, Industrial 2of5 and Matrix 2of5. The barcode inter-character pitch is set by specifying the character pitch <P> immediately before.

If not set, the inter-character pitch will be of the same size as a narrow space width.

Command	Ratio	Narrow space width	<P>	Inter-character gap	
				Narrow bar width: 1	Narrow bar width: 2
<BD>	2:5	2	Nil	2	4
			<P>0	2	4
			<P>1	1	2
			<P>2	2	4
			<P>3	3	6
			<P>4	4	8

- For print data of each barcode type, refer to the code tables of barcode.
- The barcode translation of following codes will be restricted to conditions below: JAN/EAN8, JAN/EAN13, UPC-A

For 203 dpi (8 dots/mm) : Narrow bar width must be [02], [03]
 HRI will not be printed if the value other than the listed above is specified.

[Notes]

- If the value other than valid range is set, command error will occur and barcode will not be printed.
- Barcode will be printed even if the data exceed the printing area.
- Increasing narrow bar width may exceed the print area.
- Scanner may not read the barcode with valid character pitch when Character Pitch <P> is increased. Also, increasing the narrow bar width may cause the same type of problem. For more information, refer to the documentation of your scanner.
- For specifying the narrow bar width, consider the reading compatibility of scanner and head density beforehand.
- Adjust Print Speed <CS> or Print Darkness <#F> if there is a problem in barcode reading.
- Matrix 2of5 will be expressed as Coop2of5/NEC2of5.
- If Start/Stop character is not included in print data at the time of CODABAR (NW-7) or CODE39 specified, barcode will be printed; however, scanner cannot read it.
- If sending the print data including check digit at the time of JAN/EAN-13 or JAN/EAN-8 specified, set the correct calculated value. Barcode will be printed even when the data includes improper check digit; however, scanner cannot read it.

[ESC+BT] Barcode Ratio Registration

Hexadecimal code	ESC	BT	Parameter
	<1B> ₁₆	<42> ₁₆ <54> ₁₆	abbccddee
Initial value	Nil		

Valid range and term of command	When the power is OFF	The set parameter is not maintained.
	Valid range within items	The set parameter becomes invalid.
	Valid range between items	The set parameter becomes invalid.

[Function]

Specifies the ratio of the narrow bar in regard to the wide bar.

[Format]

<BD>abbccddee

- Parameter
 - a [Barcode type]
 - 0: CODABAR(NW-7)
 - 1: CODE39
 - 2: ITF
 - 5: Industrial 2of5
 - 6: Matrix 2of5 (Coop2of5, NEC2of5)
 - b [Narrow space] = Valid range : 01 to 99 dots
 - c [Wide space] = Valid range : 01 to 99 dots
 - d [Narrow bar] = Valid range : 01 to 99 dots
 - e [Wide bar] = Valid range : 01 to 99 dots

[Coding Example]

Barcode type: CODE39, Narrow space: 03, Wide space: 05, Narrow bar: 03, Wide bar: 05

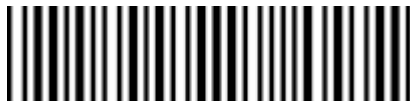

```
<A>
<BT>103050305
<V>100<H>100<BW>01233*ABCD*
<Q>2
<Z>
```

[Supplementary Explanation]

- To print barcode with specified ratio, insert "Barcode print by specified ratio" command <BW> after this command.
- When <BW> and the Print Quantity <Q> command are not specified, only the registration of bar width ratio of narrow and wide bars will be performed.
- Only one ratio can be registered.
- If the data other than specified is set, this will not be registered due to command error.
- Matrix 2of5 is expressed as Coop2of5/NEC2of5.

[ESC+BW] Barcode print by specified ratio

Hexadecimal code	ESC	BW	Parameter
	<1B> ₁₆	<42> ₁₆ <57> ₁₆	aabbbn...n
Initial value	Nil		

Valid range and term of command	When the power is OFF	The set parameter is not maintained.
	Valid range within items	The set parameter becomes invalid.
	Valid range between items	The set parameter becomes invalid.

[Function]

Specifies barcode ratio, saved by <BT>.

[Format]

<BW>aabbbn...n

- Parameter
 - a [Narrow bar] = Valid Range : 01 to 36 dot
 - b [Height of Barcode] = Valid Range : 001 to 999 dot
 - n [Print data] = Barcode data

[Coding Example]

Narrow bar: 02, Height of Barcode: 120

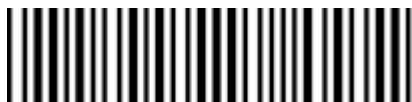

```
<A>
<BT>103060306
<V>100<H>200<BW>02120*ABCD*
<Q>2
<Z>
```

[Supplementary Explanation]

- Barcode character pitch is available for CODABAR (NW-7), CODE39, Industrial 2of5, Matrix 2of5.

To specify barcode character pitch, insert Character Pitch <P> right before Barcode type. When <P> is omitted, character pitch will be as same as narrow space width and it is a multiple of narrow bar width.

- Example)

Command	Ratio	Narrow space width	<P> specification	Gap between characters	
				Narrow bar width is [1]	Narrow bar width is [2]
<BT>	3:5	3	None	3	6
			<P>0	3	6
			<P>1	1	2
			<P>2	2	4
			<P>3	3	6
			<P>4	4	8

- If there is no Registration of Bar Width Ratio <BT>, barcode based on pre-registered bar width ratio of narrow and wide bars will be printed. Note that specification of <BT> is required beforehand to print.
- For print data for Barcode type, refer to Code table for each Barcode.

[Note]

- If the value other than valid range is set, command error will occur and barcode will not be printed.
- Barcode will be printed even if the data exceed the printing area.
- Increasing narrow bar width may exceed the print area and not be printed.
- Scanner may not read the barcode with valid character pitch when Character Pitch <P> is increased. Also, increasing the narrow bar width may cause the same type of problem. For more information, refer to the documentation of your scanner.
- For specifying the narrow bar width, consider the reading compatibility of scanner beforehand.
- Adjust Print Speed <CS> or Print Darkness <#F> if there is a problem in barcode reading.
- Matrix 2of5 is expressed as Coop2of5/NEC2of5.
- When CODABAR (NW-7) and CODE39 is specified and Start/Stop character is not included in it, Barcode is printed but Scanner cannot read it.

CODABAR (NW-7) Code table

				S				I				S				O				
				B8	0	0	0	0	0	0	0	0	1	1	1	1	1	1	1	1
				B7	0	0	0	0	1	1	1	1	0	0	0	0	1	1	1	1
				B6	0	0	1	1	0	0	1	1	0	0	1	1	0	0	1	1
				B5	0	1	0	1	0	1	0	1	0	1	0	1	0	1	0	1
B4	B3	B2	B1		0	1	2	3	4	5	6	7	8	9	A	B	C	D	E	F
0	0	0	0	0				0												
0	0	0	1	1				1	A		a									
0	0	1	0	2				2	B		b									
0	0	1	1	3				3	C		c									
0	1	0	0	4			\$	4	D	T	d	t								
0	1	0	1	5				5	E		e									
0	1	1	0	6				6												
0	1	1	1	7				7												
1	0	0	0	8				8												
1	0	0	1	9				9												
1	0	1	0	A			*	:												
1	0	1	1	B			+													
1	1	0	0	C																
1	1	0	1	D			-													
1	1	1	0	E			.		N		n									
1	1	1	1	F			/													

- As a standard, 0x20 (SP) is not available, and no error will occur to printer and space will be printed due to the specification.
- Characters which can be used as Start/Stop characters are [A, B, C, D, E, N, T, a, b, c, d, e, n, t, *] in the code table.
- Characters [\$, +, -, ., /, 0~9, :] can be used as print data.

CODE39 Code table

				S				I				S				O				
				B8	0	0	0	0	0	0	0	0	1	1	1	1	1	1	1	1
				B7	0	0	0	0	1	1	1	1	0	0	0	0	1	1	1	1
				B6	0	0	1	1	0	0	1	1	0	0	1	1	0	0	1	1
				B5	0	1	0	1	0	1	0	1	0	1	0	1	0	1	0	1
B4	B3	B2	B1		0	1	2	3	4	5	6	7	8	9	A	B	C	D	E	F
0	0	0	0	0			SP	0		P										
0	0	0	1	1				1	A	Q										
0	0	1	0	2				2	B	R										
0	0	1	1	3				3	C	S										
0	1	0	0	4			\$	4	D	T										
0	1	0	1	5			%	5	E	U										
0	1	1	0	6				6	F	V										
0	1	1	1	7				7	G	W										
1	0	0	0	8				8	H	X										
1	0	0	1	9				9	I	Y										
1	0	1	0	A			*		J	Z										
1	0	1	1	B			+		K											
1	1	0	0	C					L											
1	1	0	1	D			-		M											
1	1	1	0	E			.		N											
1	1	1	1	F			/		O											

[ESC+BC] CODE 93 Barcode

Hexadecimal code	ESC	BC	Parameter
	<1B> ₁₆	<42> ₁₆ <43> ₁₆	aabbccn...n
Initial value	Nil		

Valid range and term of command	When the power is OFF	The set parameter is not maintained.
	Valid range within items	The set parameter becomes invalid.
	Valid range between items	The set parameter becomes invalid.

[Function]

Specifying CODE93 barcode.

[Format]

<BC>aabbccn...n

- Parameter
 - a [Narrow bar] = Valid Range : 01 to 36 dots
 - b [Height of Barcode] = Valid Range : 001 to 999 dots
 - c [Digit No. of data] = Valid Range : 01 to 99
 - n [Print data] = Barcode data(Refer to the CODE93 – Code Table.)

[Coding Example]

Narrow bar width: 02, Barcode height: 120, Number of digit: 12, Print data: ABCD123456xy



```
<A>
<V>100<H>200<BC>0212012ABCD123456xy
<Q>2
<Z>
```

[Supplementary Explanation]

- C/D is an auto-generation.
- Start code and stop code will be automatically added.
- Maximum entry digit number of data is 99.
- [Digit No. of data] and No. of input data have to be equal.
- Command error will occur when No. of input data and [Digit No. of data] are not matched.

CODE93 Code table

				S				I				S				O				
				B8	0	0	0	0	0	0	0	0	0	1	1	1	1	1	1	1
				B7	0	0	0	0	1	1	1	1	0	0	0	0	1	1	1	1
				B6	0	0	1	1	0	0	1	1	0	0	1	1	0	0	1	1
				B5	0	1	0	1	0	1	0	1	0	1	0	1	0	1	0	1
B4	B3	B2	B1	0	1	2	3	4	5	6	7	8	9	A	B	C	D	E	F	
0	0	0	0	0		SP	0	@	P	`	p									
0	0	0	1	1		!	1	A	Q	a	q									
0	0	1	0	2		"	2	B	R	b	r									
0	0	1	1	3		#	3	C	S	c	s									
0	1	0	0	4		\$	4	D	T	d	t									
0	1	0	1	5		%	5	E	U	e	u									
0	1	1	0	6		&	6	F	V	f	v									
0	1	1	1	7		'	7	G	W	g	w									
1	0	0	0	8		(8	H	X	h	x									
1	0	0	1	9)	9	I	Y	i	y									
1	0	1	0	A		*	:	J	Z	j	z									
1	0	1	1	B		+	;	K	[k	[
1	1	0	0	C		,	<	L	¥	l										
1	1	0	1	D		-	=	M]	m]									
1	1	1	0	E		.	>	N	^	n	~									
1	1	1	1	F		/	?	O	_	o	DEL									

You can specify from 00H to 7FH for CODE93.

[ESC+BF] UPC Add-on (Bookland)

Hexadecimal code	ESC	BF	Parameter
	<1B> ₁₆	<42> ₁₆ <46> ₁₆	aabbn...n
Initial value	Nil		

Valid range and term of command	When the power is OFF	The set parameter is not maintained.
	Valid range within items	The set parameter becomes invalid.
	Valid range between items	The set parameter becomes invalid.

[Function]

Specifying UPC Add-on code (Bookland).

[Format]

<BF>aabbn...n

- Parameter
 - a [Narrow bar width] = Valid range : 01 to 36 dots
 - b [Height of barcode] = Valid range : 001 to 999 dots
 - n [Print data] = Numeric (0 to 9) : 2, 5 digits

[Coding Example]

Narrow bar width: 03, Barcode height: 120



```
<A>
<H>325<V>725<BD>H0315009827721123
<H>640<V>760<BF>0312021826
<H>655<V>730<OB>21826
<Q>1
<Z>
```

[Supplementary Explanation]

- If specifying the value other than 2 and 5 digits, barcode will not be printed.
- Only numeric can be specified as print data. (Refer to code table.)
- No HRI
- When printed only UPC add-on <BF>, it cannot be scanned.
Scan is available only when it is printed with UPS code.

UPC Add-on Barcode Code table

				S				I				S				O				
				B8	0	0	0	0	0	0	0	0	1	1	1	1	1	1	1	1
				B7	0	0	0	0	1	1	1	1	0	0	0	0	1	1	1	1
				B6	0	0	1	1	0	0	1	1	0	0	1	1	0	0	1	1
				B5	0	1	0	1	0	1	0	1	0	1	0	1	0	1	0	1
B4	B3	B2	B1		0	1	2	3	4	5	6	7	8	9	A	B	C	D	E	F
0	0	0	0	0				0												
0	0	0	1	1				1												
0	0	1	0	2				2												
0	0	1	1	3				3												
0	1	0	0	4				4												
0	1	0	1	5				5												
0	1	1	0	6				6												
0	1	1	1	7				7												
1	0	0	0	8				8												
1	0	0	1	9				9												
1	0	1	0	A																
1	0	1	1	B																
1	1	0	0	C																
1	1	0	1	D																
1	1	1	0	E																
1	1	1	1	F																

[ESC+BG] Code 128 Barcode

Hexadecimal code	ESC	BG	Parameter
	<1B> ₁₆	<42> ₁₆ <47> ₁₆	aabbbn...n
Initial value	Nil		

Valid range and term of command	When the power is OFF	The set parameter is not maintained.
	Valid range within items	The set parameter becomes invalid.
	Valid range between items	The set parameter becomes invalid.

[Function]

Specifying CODE128 barcode.

[Format]

<BG>aabbbn...n

- Parameter
 - a [Narrow bar] = Valid Range : 01 to 36 dots
 - b [Height of Barcode] = Valid Range : 001 to 999 dots
 - n [Print data] = Barcode data (Refer to the CODE128 – Code Table)

[Coding Example]

Narrow bar width: 02, Barcode height: 120, Print data: ABCD123456 (Start character A)



```
<A>
<V>100<H>200<BG>02120<G>ABCD123456
<Q>2
<Z>
```

[Supplementary Explanation]

- Specify [START CODE] at the head of print data.
 - START CODE A = [>G]
 - START CODE B = [>H]
 - START CODE C = [>I]
- C/D is an auto-generation.
- About "START CODE";
 - When using "START CODE C", specify print data in even-numbered digit.
 - When "START CODE C" is set to print data in odd-number digit, specify "START CODE A" or "B" to change the first one character of print data. And then specify the rest of data with "Code Set Character C" to change it to even-numbered digit.
 - e.g.1) 15 digits [123456789012345] : 1<C>23456789012345
 - e.g.2) 9 digits / Alphanumeric 6 digits [123456789ABC123] : <C>123456789ABC123
 - When odd digits are specified with START CODE C, the behavior changes depending on printer settings.

- Prints with 0 (zero) added to the last digit of the print data when SBPL -> Compatible -> CODE128(C) is enabled from menu.
- A command error will occur and the barcode will not be printed when SBPL-> Compatible -> CODE128(C) is disabled from menu.
- When start character is omitted, data will be printed with "START CODE B".

CODE128 – Code Table

VALUE	Code A	Code B	Code C
1	SP	SP	00
2	!	!	01
3	"	"	02
4	#	#	03
5	\$	\$	04
6	%	%	05
7	&	&	06
8	,	,	07
9	((08
10))	09
11	*	*	10
12	+	+	11
13	,	,	12
14	-	-	13
15	.	.	14
16	/	/	15
17	0	0	16
18	1	1	17
19	2	2	18
20	3	3	19
21	4	4	20
22	5	5	21
23	6	6	22
24	7	7	23
25	8	8	24
26	9	9	25
27	:	:	26
28	;	;	27
29	<	<	28
30	=	=	29
31	>(Note 4.)	>(Note 4.)	30
32	?	?	31
33	@	@	32
34	A	A	33
35	B	B	34
36	C	C	35
37	D	D	36
38	E	E	37
39	F	F	38
40	G	G	39
41	H	H	40
42	I	I	41
43	J	J	42
44	K	K	43
45	L	L	44
46	M	M	45
47	N	N	46
48	O	O	47
49	P	P	48
50	Q	Q	49
51	R	R	50
52	S	S	51
53	T	T	52
54	U	U	53
55	V	V	54
56	W	W	55
57	X	X	56
58	Y	Y	57
59	Z	Z	58
60	[[59
61	\	\	60
62]]	61
63	^	^	62
64	NUL >SP	^	63
65	SOH >!	a	64
			65

66	STX	>"	b	66	
67	ETX	>#	c	67	
68	EOT	>\$	d	68	
69	ENQ	>%	e	69	
70	ACK	>&	f	70	
71	BEL	>'	g	71	
72	BS	>(h	72	
73	HT	>)	i	73	
74	LF	>*	j	74	
75	VT	>+	k	75	
76	FF	>,	l	76	
77	CR	>-	m	77	
78	SO	>.	n	78	
79	SI	>/	o	79	
80	DLE	>0	p	80	
81	DC1	>1	q	81	
82	DC2	>2	r	82	
83	DC3	>3	s	83	
84	DC4	>4	t	84	
85	NAK	>5	u	85	
86	SYN	>6	v	86	
87	ETB	>7	w	87	
88	CAN	>8	x	88	
89	EM	>9	y	89	
90	SUB	>:	z	90	
91	ESC	>;	{	91	
92	FS	><		92	
93	GS	>=	}	93	
94	RS	>>	~	94	
95	US	>?	DEL	>?	95
96	FNC3	>@	FNC3	>@	96
97	FNC2	>A	FNC2	>A	97
98	SHIFT	>B	SHIFT	>B	98
99	Code-C	>C	Code-C	>C	99
100	Code-B	>D	FNC4	>D	Code-B >D
101	FNC4	>E	Code-A	>E	Code-A >E
102	FNC1	>F	FNC1	>F	FNC1 >F
103	START	CODE A >G			
104		B >H			
105		C >I			

Note

- If START character (start code) is omitted, it works as code B, but 2-byte characters cannot be specified.
- STOP character (stop code) is added in the printer automatically.
- Code after VALUE64 in Code A and Code B should be specified as 2 character code with ">" attached.
- Specification code for ">" is ">J".

[ESC+BI] GS1-128 (UCC/EAN128) (Standard Carton ID Only)

Hexadecimal code	ESC	BI	Parameter
	<1B> ₁₆	<42> ₁₆ <49> ₁₆	aabbbcn...n
Initial value	Nil		

Valid range and term of command	When the power is OFF	The set parameter is not maintained.
	Valid range within items	The set parameter becomes invalid.
	Valid range between items	The set parameter becomes invalid.

[Function]

Specifying GS1-128 (UCC/EAN128) barcode for Standard Carton ID.

[Format]

<BI>aabbbcn...n

- Parameter
 - a [Narrow bar] = Valid Range : 01 to 36 dots
 - b [Height of Barcode] = Valid Range : 001 to 999 dots
 - c [Barcode expository font specification]
 - 0: No HRI
 - 1: HRI is available (Upper part of barcode)
 - 2: HRI is available (Under part of barcode)
 - n [Print data] = Barcode data (Fixed 17 digits)

For barcode data, refer to the GS1-128 (UCC/EAN128) code table.
EAN128 (Barcode for Standard Carton ID)

- Identifier of a continuous code for freight packaging
- Type of packaging
- Country/manufacturer code
- Serial No. for shipping container
- Check digit

Note that check digit is automatically added; therefore, specify data in 17 digits excluding check digit.

[Coding Example]

Narrow bar width:05, Height of barcode:080, HRI: Available (Under part of barcode), Print data:12345678901234567



<A>
<V>100<H>200<BI>05080212345678901234567
<Q>2
<Z>

[Supplementary Explanation]

- UCC128 code is exclusive to Standard Carton ID. When printing in EAN128, designed for the markets in the medical, fresh food, or flowers and plants, use CODE128 Barcode <BG> to specify print data with application identification or separator that matches each specification.
- Start character code, function character, end character code, and identification code (corresponds to [00] only) are added automatically.
- Modulus 10 check character and modulus 103 check character are automatically generated.
- Sequential number of barcode data is available.
- Line pitch between barcode and expository font is fixed at 10 dots.
- If the width of expository font is wider than that of barcode, it starts printing from the print start position of barcode.
- If the width of expository font is narrower than that of barcode, expository font will be aligned to the center of barcode for printing.
- Prints expository font in OCR-B.
- If expository font is outside of printing area, it will not be printed. When selecting [HRI is available], specify Vertical Print Position <V> and Horizontal Print Position <H> in consideration of print of expository font.
- If the bar code commentary font specification to specify other than 0, 1, 2, operation is the same as the bar code commentary font specified 0.

ITF, Matrix 2of5, Industrial 2of5, UPC-A, JAN/EAN8, JAN/EAN13, UPC-E, GS1-128 (UCC/EAN128), MSI Code table

				S				I				S				O				
				B8	0	0	0	0	0	0	0	0	0	1	1	1	1	1	1	1
				B7	0	0	0	0	1	1	1	1	0	0	0	0	1	1	1	1
				B6	0	0	1	1	0	0	1	1	0	0	1	1	0	0	1	1
				B5	0	1	0	1	0	1	0	1	0	1	0	1	0	1	0	1
B4	B3	B2	B1		0	1	2	3	4	5	6	7	8	9	A	B	C	D	E	F
0	0	0	0	0				0												
0	0	0	1	1				1												
0	0	1	0	2				2												
0	0	1	1	3				3												
0	1	0	0	4				4												
0	1	0	1	5				5												
0	1	1	0	6				6												
0	1	1	1	7				7												
1	0	0	0	8				8												
1	0	0	1	9				9												
1	0	1	0	A																
1	0	1	1	B																
1	1	0	0	C																
1	1	0	1	D																
1	1	1	0	E																
1	1	1	1	F																

[ESC+BP] Postnet

Hexadecimal code	ESC	BP	Parameter
	<1B> ₁₆	<42> ₁₆ <50> ₁₆	n...n
Initial value	Nil		

Valid range and term of command	When the power is OFF	The set parameter is not maintained.
	Valid range within items	The set parameter becomes invalid.
	Valid range between items	The set parameter becomes invalid.

[Function]

Specifying POSTNET barcode.

[Format]

<BP>n...n

- Parameter

n = Print data (Refer to the POSTNET Code Table)

Note that the digits other than specified below are not allowed.

- 5 digits (POSTNET-32 format)
- 6 digits (POSTNET-37 format)
- 9 digits (POSTNET-52 format)
- 11 digits (POSTNET-62 Delivery Point format)

[Coding Example]

Postal code: 11 digits: 01234567890

<A>

<V>100<H>200<BP>**01234567890**

<Q>2

<Z>

[Supplementary Explanation]

- If specifying the value other than 5, 6, 9, and 11 digits for print data, it will be ignored.
- Only numeric can be specified as print data.

POSTNET Code table

				S	I	S	O													
				b8	0	0	0	0	0	0	0	0	1	1	1	1	1	1	1	1
				b7	0	0	0	0	1	1	1	1	0	0	0	0	1	1	1	1
				b6	0	0	1	1	0	0	1	1	0	0	1	1	0	0	1	1
				b5	0	1	0	1	0	1	0	1	0	1	0	1	0	1	0	1
b4	b3	b2	b1		0	1	2	3	4	5	6	7	8	9	A	B	C	D	E	F
0	0	0	0	0				0												
0	0	0	1	1				1												
0	0	1	0	2				2												
0	0	1	1	3				3												
0	1	0	0	4				4												
0	1	0	1	5				5												
0	1	1	0	6				6												
0	1	1	1	7				7												
1	0	0	0	8				8												
1	0	0	1	9				9												
1	0	1	0	A																
1	0	1	1	B																
1	1	0	0	C																
1	1	0	1	D																
1	1	1	0	E																
1	1	1	1	F																

[ESC+BS] USPS Barcode

Hexadecimal code	ESC	BS	Parameter
	<1B> ₁₆	<42> ₁₆ <53> ₁₆	aabbccccccddddddd(e...e)
Initial value	Nil		

Valid range and term of command	When the power is OFF	The set parameter is not maintained.
	Valid range within items	The set parameter becomes invalid.
	Valid range between items	The set parameter becomes invalid.

[Function]

Printing USPS code.

[Format]

<BS>aabbccccccddddddd(e...e)

- Parameter
 - a [Barcode ID] = Fixed 2 digits
note: 0 to 4 should be specified for the 2nd digit.
 - b [Service Type ID] = Fixed 3 digits
 - c [Mailer ID] = Fixed 6 digits
 - d [Serial Number] = Fixed 9 digits
 - e [Routing Code] = Fixed 5 digits or fixed 9 digits or fixed 11 digits(can be omitted)

[Coding Example]

Barcode ID: 53, Service Type ID: 379, Customer Identifier: 777234, Serial Number: 994544928, Routing Code: 51135759461

```
<A>
<V>100<H>200<BS>5337977723499454492851135759461
<Q>1
<Z>
```

[Supplementary note]

- For available parameter, refer to USPS code table in next page.

USPS Code table

				S				I				S				O				
				b8	0	0	0	0	0	0	0	0	1	1	1	1	1	1	1	1
				b7	0	0	0	0	1	1	1	1	0	0	0	0	1	1	1	1
				b6	0	0	1	1	0	0	1	1	0	0	1	1	0	0	1	1
				b5	0	1	0	1	0	1	0	1	0	1	0	1	0	1	0	1
b4	b3	b2	b1		0	1	2	3	4	5	6	7	8	9	A	B	C	D	E	F
0	0	0	0	0				0												
0	0	0	1	1				1												
0	0	1	0	2				2												
0	0	1	1	3				3												
0	1	0	0	4				4												
0	1	0	1	5				5												
0	1	1	0	6				6												
0	1	1	1	7				7												
1	0	0	0	8				8												
1	0	0	1	9				9												
1	0	1	0	A																
1	0	1	1	B																
1	1	0	0	C																
1	1	0	1	D																
1	1	1	0	E																
1	1	1	1	F																

[ESC+EU] Composite symbol

Hexadecimal code	ESC	EU	Parameter
	<1B> ₁₆	<45> ₁₆ <55> ₁₆	aaabbn...n
Initial value	Nil		

Valid range and term of command	When the power is OFF	The set parameter is not maintained.
	Valid range within items	The set parameter becomes invalid.
	Valid range between items	The set parameter becomes invalid.

[Function]

Specifying the composite symbol of EAN/UCC.

[Format 1]

<EU>aabbccn...n

- Parameter
 - a [Type of composite symbol]
 - 01 : GS1 DataBar Composite (CC-A/CC-B)
 - 02 : GS1 DataBar Truncated Composite (CC-A/CC-B)
 - 03 : GS1 DataBar Stacked Composite (CC-A/CC-B)
 - 04 : GS1 DataBar Stacked Omni-Directional (CC-A/CC-B)
 - 05 : GS1 DataBar Limited Composite (CC-A/CC-B)
 - 06 : GS1 DataBar Expanded Composite (CC-A/CC-B)
 - /GS1 DataBar Expanded Stacked (CC-A/CC-B)
 - 07 : UPC-A Composite (CC-A/CC-B)
 - 08 : UPC-E Composite (CC-A/CC-B)
 - 09 : EAN13 Composite (CC-A/CC-B)
 - 10 : EAN8 Composite (CC-A/CC-B)
 - b [Narrow bar] = 01 to 12 dots
 - c [Segment width] = 02 to 22 (Even number only)
 - * Only GS1 DataBar Expanded Composite (CC-A/CC-B) are supported.
 - n [Print data] = Data

Maximum number of digit for 1D barcode data

GS1 DataBar Composite (CC-A/CC-B)	13 digits
GS1 DataBar Truncated Composite (CC-A/CC-B)	13 digits
GS1 DataBar Stacked Composite (CC-A/CC-B)	13 digits
GS1 DataBar Stacked Omni-Directional (CC-A/CC-B)	13 digits
GS1 DataBar Limited Composite (CC-A/CC-B)	13 digits
GS1 DataBar Expanded Composite (CC-A/CC-B) /GS1 DataBar Expanded Stacked (CC-A/CC-B)	74 digits
UPC-A Composite (CC-A/CC-B)	11 digits
UPC-E Composite (CC-A/CC-B) Specify with "XX00000XXX" (X: variable) format.	Fixed 10 digits
EAN13 Composite (CC-A/CC-B)	12 digits
EAN8 Composite (CC-A/CC-B)	7 digits

- Check digit is automatically calculated and added.

- To specify the print of composite symbol, delimit one-dimensional data and two-dimensional data with '|' (7Ch).
Data = One-dimensional data | Two-dimensional data
- Data of GS1 DataBar Composite (CC-A/CC-B) are needed to be specified between the 1st and 16th digit of GS1 DataBar Expanded Composite (CC-A/CC-B) data.
- GS1 DataBar Expanded Composite (CC-A/CC-B) can contain GS1 DataBar Composite (CC-A/CC-B) data and 74 digits of numeric character and 41 digits of alphabet.
(When numeric characters and alphabets are mixed, GS1 DataBar Composite (CC-A/CC-B) data and 41 digit characters can be specified.
Ex 1) AI(01)+Product ID code 4912345000019+AI(15)+ Best before date is set at 30/Nov.2012:
(01)04912345000019(15)121130
Ex 2) AI(01)+Product ID code 4912345000019+AI(17)+Expiration date is set at 31/Jan.2013+AI(10)+lot # ABC123:
(01)04912345000019(17)20130131(10)ABC123
- When specified data do not reach the maximum digits, blank is filled by zero.
- 2D data can contain up to 338 digits, but it varies by the type of Barcode.
- Barcode may stick out of the label depending on data and the number of digit, and scanner cannot read it. Adjust print data beforehand so that the barcode can fit to the label.
- For UPC-A Composite, you can only specify 11 digits for data entry, however when 12 digits is specified for the compatibility purpose, EAN13 Composite (CC-A/CC-B) is generated.

[Format 2]

<EU>aabbcccn...n

- Parameter
 - a [One-dimensional barcode type]
 - 11 : GS1-128 Composite (CC-A/CC-B)
 - 12 : GS1-128 Composite (CC-C)
 - b [Minimum bar width] = 01 to 12 dots
 - c [Barcode height] = 001 to 500 dots
 - * Specify barcode height when minimum bar width is "01".
 - * When specifying minimum bar width "03", Barcode height "100", Barcode height become 300 dots.
 - n [Print data] = Data (Up to 120 digits including 1D and 2D barcode)

Maximum number of digits that can specify by merging 1D and 2D (There is a limit for the maximum number of digits of 1D data.)

GS1-128 (UCC/EAN128) with CC-A/B	338 digits
GS1-128 (UCC/EAN128) with CC-C	2324 digits

Maximum number of digits that can specify 1D data

GS1-128 (UCC/EAN128) with CC-A/B	48 digits
GS1-128 (UCC/EAN128) with CC-C	48 digits

- To specify the print of composite symbol, delimit one-dimensional data and two-dimensional data with'|'(7CH).
Data = One-dimensional data | Two-dimensional data
- Use '#'(23H) to specify CC-A/B (Micro RDF), FNC1 (GS) of CC-C (for PDF417) as data.
- 2D data for GS1-128 (UCC/EAN128) With CC-A/B can contain up to 338 digits.
- Barcode part of GS1-128 Composite is GS1-128 (UCC/EAN128).

- When 2D data of GS1-128 (UCC/EAN128) with CC-A/B are less than 56 digits, it is identified as CC-A, and identified as CC-B when data size is between 57 digits and 338 digits automatically.
- The number of digits varies depending on the width of the barcode in GS1-128 (UCC/EAN128) With CC-C, and the maximum number of digits of combination of the 1D and 2D is 2372 digits.

[Coding Example1]

GS1 DataBar Composite (CC-A/CC-B)



<A>
<V>100<H>100
<EU>01040361234567890|11990102
<Q>1
<Z>

[Coding Example2]

GS1 DataBar Truncated Composite (CC-A/CC-B)



<A>
<V>100<H>100
<EU>02040361234567890|11990102
<Q>1
<Z>

[Coding Example3]

GS1 DataBar Stacked Composite (CC-A/CC-B)



<A>
<V>100<H>100
<EU>03040341234567890|17010200
<Q>1
<Z>

[Coding Example4]

GS1 DataBar Stacked Omni-Directional (CC-A/CC-B)



<A>
<V>100<H>100
<EU>04040341234567890|17010200
<Q>1
<Z>

[Coding Example5]

GS1 DataBar Limited Composite (CC-A/CC-B)



<A>
<V>100<H>100
<EU>05040351234567890|21ABCDEFGHIJKLMNQRSTU
<Q>1
<Z>

[Coding Example6]

GS1 DataBar Expanded Composite(CC-A/CC-B)



<A>
<V>100<H>100
<EU>0605220104912345678904
<Q>1
<Z>

[Coding Example7]

GS1 DataBar Expanded Stacked(CC-A/CC-B)



<A>
<V>100<H>100
<EU>0605020104912345678904
<Q>1
<Z>

[Coding Example8]

UPC-A Composite (CC-A/CC-B)



<A>
<V>100<H>100
<EU>0704331234567890|991234-abcd
<Q>1
<Z>

[Coding Example9]

UPC-E Composite (CC-A/CC-B)

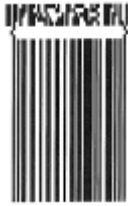

<A>
<V>100<H>100
<EU>08041200000123|15021231
<Q>1
<Z>

[Coding Example10]

EAN13 Composite (CC-A/CC-B)



<A>
<V>100<H>100
<EU>0904331234567890|991234-abcd
<Q>1
<Z>

[Coding Example11]

EAN8 Composite (CC-A/CC-B)



<A>
<V>100<H>100
<EU>10041234567|21A12345678
<Q>1
<Z>

[Coding Example12]

GS1-128 Composite (CC-A/CC-B)



<A>
<V>100<H>100
<EU>11040260103212345678906|21A1B2C3D4E5F6G7H8
<Q>1
<Z>

[Coding Example13]

GS1-128 Composite (CC-C)



<A>

<V>100<H>100

<EU>120402600030123456789012340|02130123456789

093724#101234567ABCDEFG

<Q>1

<Z>

[Supplementary Explanation]

- Parameter varies depending on one-dimensional barcode type.
Segment width can be specified only for DataBar Expanded Composite (CC-A/CC-B) (EU06).
Barcode height can be specified only for GS1-128 (UCC/EAN-128) (EU11, EU12).
- If the value is not set to the data portion, composite symbol will not be printed.
- Parameter for print data is available up to 2361 digits including 1D barcode data and 2D barcode data as a specification for this command. Available number for 2D barcode data varies depending on the type of 1D barcode and/or mixture of alphabets and number. When specified data exceed the maximum digits, barcode may not be printed properly.
- Entire size of composite symbol changes depending on the specification of narrow bar width.
- If composite symbol exceeds the printing area, only the portion located within the area will be printed, and a scanner might read the value of such composite symbol occasionally.
- Height and width of 2D barcode of the composite symbol is adjusted by 1D barcode data size. When the width of 1D barcode is narrow, it cannot be printed even the size of data is less than the maximum number of digit.
- Print of HRI cannot be designated with this command.
- Rotation <%> is available, and Enlargement <L> is invalid.
- When specifying 11 (production date), 12 (term of payment), 13 (packing date), 15 (sales period), 17 (warranty period) for application identifier, set correct data YYMMDD. When the incorrect date is set, print result is not guaranteed.
- When specifying GS1 DataBar as a barcode type, specify 2D Barcode data with the format based on application identifier.
- GS1 DataBar Expanded Composite (CC-A/CC-B) is stacked automatically by segment width and data size and printed as GS1 DataBar Expanded Stacked (CC-A/CC-B).
- Barcode generation module has been modified for improvement. How the generated image looks may differ due to the change, however the read result is the same.

Code table for Composite Symbol 2D Barcode

				S				I				S				O					
				b8	0	0	0	0	0	0	0	0	0	1	1	1	1	1	1	1	1
				b7	0	0	0	0	1	1	1	1	0	0	0	0	1	1	1	1	
				b6	0	0	1	1	0	0	1	1	0	0	1	1	0	0	1	1	
				b5	0	1	0	1	0	1	0	1	0	1	0	1	0	1	0	1	
b4	b3	b2	b1		0	1	2	3	4	5	6	7	8	9	A	B	C	D	E	F	
0	0	0	0	0			SP	0		P		p									
0	0	0	1	1			!	1	A	Q	a	q									
0	0	1	0	2			"	2	B	R	b	r									
0	0	1	1	3				3	C	S	c	s									
0	1	0	0	4				4	D	T	d	t									
0	1	0	1	5			%	5	E	U	e	u									
0	1	1	0	6			&	6	F	V	f	v									
0	1	1	1	7			'	7	G	W	g	w									
1	0	0	0	8			(8	H	X	h	x									
1	0	0	1	9)	9	I	Y	i	y									
1	0	1	0	A			*	:	J	Z	j	z									
1	0	1	1	B			+	;	K		k										
1	1	0	0	C			,	<	L		l										
1	1	0	1	D			-	=	M		m										
1	1	1	0	E			.	>	N		n										
1	1	1	1	F			/	?	O	_	o										

* Use '#(23H) for specifying FNC1.

[ESC+BL] UPC-A Barcode (Without HRI)

Hexadecimal code	ESC	BL	Parameter
	<1B> ₁₆	<42> ₁₆ <4C> ₁₆	abbcccn...n
Initial value	Nil		

Valid range and term of command	When the power is OFF	The set parameter is not maintained.
	Valid range within items	The set parameter becomes invalid.
	Valid range between items	The set parameter becomes invalid.

[Function]

Set the height of character barcode of the first digit and the last digit to the same height of the guard bar.

[Format]

<BL>abbcccn...n

- Parameter
 - a [Barcode type] = H : UPC-A(Fixed 'H')
 - b [Narrow bar] = Valid Range : 01 to 36 dots
 - c [Height of Barcode] = Valid Range : 001 to 999 dots
 - n [Print data] = Data : 11 fixed digits

[Coding Example]

Barcode type: UPC-A, Narrow bar width: 03, Barcode height: 120, Print data: 01234567890

```
<A>
<H>100<V>100<BL>H0312001234567890
<Q>2
<Z>
```

[Supplementary Explanation]

- This command supports UPC-A only. When barcode type is specified other than "H", command error occurs.
- Setting of Guard bar, HRI and ratio is described as follows.

Guard bar : Available

HRI : Nil

Ratio : Fix

- When the parameter value exceeds the range, operation is not supported.
- When printing UPC-A with <D>, all character barcodes have the same height. When <BL> is used, the height of the character barcode of the start digit and the last digit have the same height of the guard bar.

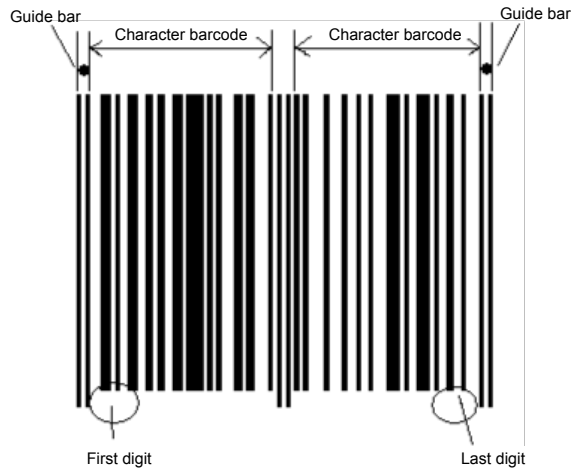

UPC-A specifying <D>

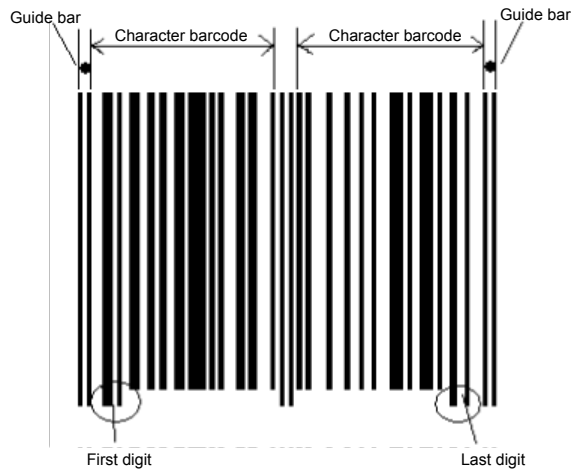

UPC-A specifying <BL>

[ESC+BL] ~ [ESC+d] UPC-A Barcode (Specifying HRI)

Hexadecimal code	ESC	BL~d	Parameter
	<1B> ₁₆	<42> ₁₆ <4C> ₁₆ ~ character type	abbcccn...n ~ <d>n...n
Initial value	Nil		

Valid range and term of command	When the power is OFF	The set parameter is not maintained.
	Valid range within items	The set parameter becomes invalid.
	Valid range between items	The set parameter becomes invalid.

[Function]

Set the height of character barcode of the first digit and the last digit to the same height of the guard bar.

[Format]

<BL>abbcccn...n ~ <d>n...n

- Parameter
 - a [Barcode type] = H : UPC-A (Fixed 'H')
 - b [Narrow bar] = Valid Range : 01 to 36 dots
 - c [Height of barcode] = Valid range : 001 to 999 dots
 - n [Print data] = Data : Fixed 11 digit
 - d [Font type]
 - OA
 - OB
 - XU
 - XS
 - XM
 - XB
 - XL
 - U
 - S
 - M
 - WB
 - WL
 - n [Print data] = HRI data : fixed 12 digits

[Coding Example]

Barcode type: UPC-A, Narrow bar width: 02. Barcode height: 120, Print data: 01234567890, Font type: XS, HRI data: 01234567890

```
<A>
<V>100<H>100<BL>H0212001234567890
<XS>01234567890
<Q>2
<Z>
```

[Supplementary Explanation]

- This command supports UPC-A only. When barcode type is specified other than "H", command error occurs.
- Recommended to specify [02] or [03] for the narrow bar width.
- Check digit (12th digit) for HRI data should be set the calculation result of modulus 10.
- Setting of Guard bar, HRI and Ratio is following.

Guard bar : Available
 HRI : Available
 Ratio : Fix

- When the parameter value exceeds the range, operation is not supported.
- If barcode with human readable text has errors, the human readable text is printed in a normal font.
- All character barcode have the same height when printing UPC-A specifying <BD> and then . The first and the last character barcode have the same height to the guard bar when printing UPC-A specifying <BL> and then . When printing UPC-A specifying <BD> and , HRI can be printed under the first digit and the last digit because the height of the first digit and the last digit of the barcode is low. When printing UPC-A specifying <BM> and , the height of the first digit and the last digit of the barcode is high, and the font interval is narrower than previous case.



**UPC-A specifying <D> + **



**UPC-A specifying <BL> + **

[ESC+BM] UPC-A Barcode (With HRI)

Hexadecimal code	ESC	BM	Parameter
	<1B> ₁₆	<42> ₁₆ <4D> ₁₆	abbcccn...n
Initial value	Nil		

Valid range and term of command	When the power is OFF	The set parameter is not maintained.
	Valid range within items	The set parameter becomes invalid.
	Valid range between items	The set parameter becomes invalid.

[Function]

Set the character barcode height of the first and the last digit to the same height of the guard bar.

[Format 1]

<BM>abbcccn...n

- Parameter
 - a [barcode type] = H : UPC-A(fixed 'H')
 - b [Narrow bar] = Valid Range : 01 to 36 dots
 - c [Height of Barcode] = Valid Range : 001 to 999 dots
 - n [Print data] = Data : fixed 11 digits

[Coding Example]

Barcode type:UPC-A, Narrow bar width:02, Barcode height :120, Print data: 20123948573

```
<A>
<H>100<V>100<BM>H0212020123948573
<Q>2
<Z>
```

[Supplementary Explanation]

- This command supports UPC-A only. When barcode type is specified other than "H", command error occurs.
- HRI needs following conditions;
 203 dpi (8 dots /mm) : Set Narrow bar width to [02] or [03]
 When the value other than above are specified, HRI is not printed.
- Setting of Guard bar, HRI and Ratio is following.
 Guard bar : Available
 HRI : Available
 Ratio : Fix
- When the parameter value exceeds the range, operation is not supported.
- All character barcode have the same height when printing UPC-A specifying <D> and then . The first and the last character barcode have the same height to the guard bar when printing UPC-A specifying <BL> and then . When printing UPC-A specifying <D> and , HRI can be printed under the first digit and the last digit because the height of the first digit and the last digit of the barcode is low. When printing UPC-A specifying <BL> and , the height of the first digit and the last digit of the barcode is high, and the font interval is narrower than previous case.

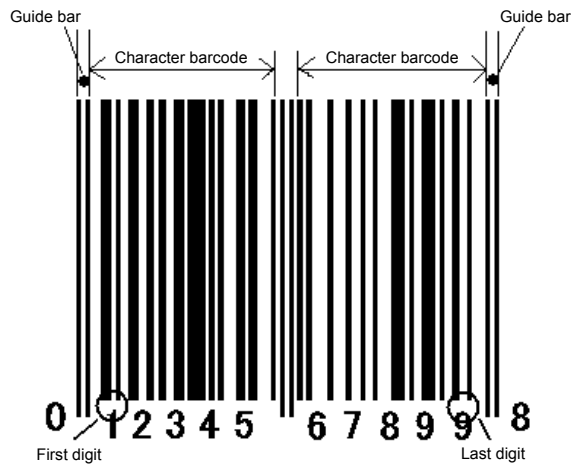

UPC-A specifying <BD>



UPC-A specifying <BM>

2D Code

[ESC+2D10] PDF417

Hexadecimal code	ESC	2D10	Parameter
	<1B> ₁₆	<32> ₁₆ <44> ₁₆ <31> ₁₆ <30> ₁₆	,aa,bb,c,dd,ee,(,f)
Initial value	Nil		

Valid range and term of command	When the power is OFF	The set parameter is not maintained.
	Valid range within items	The set parameter becomes invalid.
	Valid range between items	The set parameter becomes invalid.

[Function]

Specifying PDF417.

[Format](Setting part)

<2D10>,aa,bb,c,dd,ee,(,f)

- Parameter
 - a [Minimum module width] = Valid Range : 01 to 27 dots
 - b [Minimum module height] = Valid Range : 01 to 72 dots
 - c [Security level] = Valid Range : 0 to 8
 - d [Number of data code words per one line]
 - Valid Range : 01 to 30
 - 00 : Automatic (Width varies depending on number of data)
 - e [Number of line per symbol]
 - Valid Range : 03 to 90
 - 00 : Automatic (Height varies depending on number of data)
 - f [Code type]
 - 0 : Normal, When omitted 0(can be omitted)
 - 1 : Truncated

[Format](Data part)

<DN>mmmm,n...n

- Parameter
 - m [Number of data] = Valid Range : 1 to 2681 bytes
 - n [Print data] = Data

[Coding Example1]

Minimum module width: 03 dots, Minimum module height: 09 dots, Security level: 3, Number of data code words per line: 03, Number of line per symbol: 18



<A>
<V>100<H>200<2D10>,**03,09,3,03,18**
<DN>0010,0123456789
<Q>2
<Z>

[Coding Example 2]

Minimum module width: 03 dots, Minimum module height: 09 dots, Security level: 3, Number of data code words per line: 03, Number of line per symbol: 18, Code type: Truncated



<A>
<V>100<H>200<2D10>,**03,09,3,03,18,1**
<DN>0010,0123456789
<Q>2
<Z>

[Supplementary Explanation]

- Base print position of PDF417 is specified by vertical print position <V> and horizontal print position <H>

<V>100<H>200<2D10>***.....**

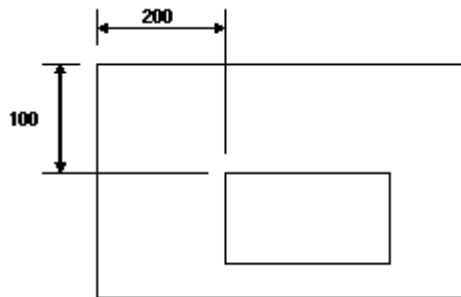

- When d=e=00, aspect ratio will be at 1:2 based on the number of print data.
- When parameter d and e does not match number of data, print may not be performed properly.
- When setting security level high, parameter d or e should have large number.
- Recommended to specify more than 2 dots for 8 dots/mm print head because the minimum module width and minimum module height of QR code may not be read by the scanner.
- Barcode generation module has been modified for improvement. How the generated image looks may differ due to the change, however the read result is the same.

[point]

- Sequential number is not available.
- Specifying print position by automatic line feed is not available.
- Print 00H to FFH is available.

- Format registration is available.
- Enlarging minimum module size improves print quality.
- Increasing security level improves read rate.
- Print height varies depending on the character such as numeric only, alphabet only or mixture of numeric and alphabets.

PDF417 Code table

				S				I				S				O						
				B8	0	0	0	0	0	0	0	0	0	1	1	1	1	1	1	1	1	
				B7	0	0	0	0	1	1	1	1	0	0	0	0	1	1	1	1	1	
				B6	0	0	1	1	0	0	1	1	0	0	1	1	0	0	1	1	1	
				B5	0	1	0	1	0	1	0	1	0	1	0	1	0	1	0	1	0	1
B4	B3	B2	B1		0	1	2	3	4	5	6	7	8	9	A	B	C	D	E	F		
0	0	0	0	0			SP	0	@	P	`	p										
0	0	0	1	1			!	1	A	Q	a	q										
0	0	1	0	2			"	2	B	R	b	r										
0	0	1	1	3			#	3	C	S	c	s										
0	1	0	0	4			\$	4	D	T	d	t										
0	1	0	1	5			%	5	E	U	e	u										
0	1	1	0	6			&	6	F	V	f	v										
0	1	1	1	7			'	7	G	W	g	w										
1	0	0	0	8			(8	H	X	h	x										
1	0	0	1	9)	9	I	Y	i	y										
1	0	1	0	A			*	:	J	Z	j	z										
1	0	1	1	B			+	;	K	[k	{										
1	1	0	0	C			,	<	L	¥	l											
1	1	0	1	D			-	=	M]	m	}										
1	1	1	0	E			.	>	N	^	n	~										
1	1	1	1	F			/	?	O	_	o	DEL										

[00H to FFH] can be available for PDF417.

[ESC+2D12] Micro PDF417

Hexadecimal code	ESC	2D12	Parameter
	<1B> ₁₆	<32> ₁₆ <44> ₁₆ <31> ₁₆ <32> ₁₆	,aa,bb,c,dd,(e)
Initial value	Nil		

Valid range and term of command	When the power is OFF	The set parameter is not maintained.
	Valid range within items	The set parameter becomes invalid.
	Valid range between items	The set parameter becomes invalid.

[Function]

Specifying Micro PDF417.

[Format](Setting part)

<2D12>,aa,bb,c,dd,(e)

- Parameter
 - a [Minimum module width] = Valid Range : 01 to 27 dots
 - b [Minimum module height] = Valid Range : 01 to 72 dots
 - c [Number of data code words per row] (Cols) = Valid Range : 1 to 4
 - d [Number of rows per symbol] (Rows) = Valid Range : 2 rows
 - e [Binary mode]
 - 0 : Normal, When omitted 0 (Can be omitted)
 - 1 : Binary mode

[Format](Data part)

<DN>mmmm,n...n : Binary mode is Binary mode

<DS>n...n : Binary mode is Normal

- Parameter
 - m [Number of data] = Valid Range : 0001 to 0366 bytes
 - n [Print data] = Data

[Coding Example]

Module width: 02 dots, Minimum module height: 04 dots, Data code word per row: 1, Rows per symbol: 14



```
<A>
<V>100<H>200<2D12>,02,04,1,14
<DN>0010,0123456789
<Q>2
<Z>
```

[Supplementary Explanation]

- Number of row per symbol is decided by number of data code words per row.
For details, refer to "Micro PDF417 – symbol size and number of data" below.
- Recommended to specify more than 2 dots for 8 dots/mm print head because the minimum module width and minimum module height of QR code may not be read by the scanner.
- Barcode generation module has been modified for improvement. How the generated image looks may differ due to the change, however the read result is the same.

Symbol size of Micro PDF417 has 34 types and shown in the table below.

- Micro PDF417 – symbol size and number of data

Symbol size		Maximum number of data		
Cols (c)	Rows (d)	Alphabet (A-Z)	Numeric	Binary mode
1	11	6	8	3
	14	12	17	7
	17	18	26	10
	20	22	32	13
	24	30	44	18
	28	38	55	22
2	8	14	20	8
	11	24	35	14
	14	36	52	21
	17	46	67	27
	20	56	82	33
	23	64	93	38
	26	72	105	43
3	6	10	14	6
	8	18	26	10
	10	26	38	15
	12	34	49	20
	15	46	67	27
	20	66	96	39
	26	90	132	54
	32	114	167	68
	38	138	202	82
	44	162	237	97
4	4	14	20	8
	6	22	32	13
	8	34	49	20

Symbol size		Maximum number of data		
Cols (c)	Rows (d)	Alphabet (A-Z)	Numeric	Binary mode
	10	46	67	27
	12	58	85	34
	15	76	111	45
	20	106	155	63
	26	142	208	85
	32	178	261	106
	38	214	313	128
	44	250	366	150

- Way of mixing alphabets (Capital, lower case), numeric characters and control codes differs by combination of number of characters.

Micro PDF417 Code table

				S				I				S				O			
				B8	B7	B6	B5												
B4	B3	B2	B1	0	1	2	3	4	5	6	7	8	9	A	B	C	D	E	F
0	0	0	0	0		SP	0	@	P	`	p								
0	0	0	1	1		!	1	A	Q	a	q								
0	0	1	0	2		"	2	B	R	b	r								
0	0	1	1	3		#	3	C	S	c	s								
0	1	0	0	4		\$	4	D	T	d	t								
0	1	0	1	5		%	5	E	U	e	u								
0	1	1	0	6		&	6	F	V	f	v								
0	1	1	1	7		'	7	G	W	g	w								
1	0	0	0	8		(8	H	X	h	x								
1	0	0	1	9)	9	I	Y	i	y								
1	0	1	0	A		*	:	J	Z	j	z								
1	0	1	1	B		+	;	K	[k	{								
1	1	0	0	C		,	<	L	¥	l									
1	1	0	1	D		-	=	M]	m	}								
1	1	1	0	E		.	>	N	^	n	~								
1	1	1	1	F		/	?	O	_	o	DEL								

Micro PDF417 can specify (00)16 to (FF)16 to print data when binary mode is specified.

[ESC+2D20] MaxiCode

Hexadecimal code	ESC	2D20	Parameter
	<1B> ₁₆	<32> ₁₆ <44> ₁₆ <32> ₁₆ <30> ₁₆	,a(,bbb,ccc,d...d)
Initial value	Nil		

Valid range and term of command	When the power is OFF	The set parameter is not maintained.
	Valid range within items	The set parameter becomes invalid.
	Valid range between items	The set parameter becomes invalid.

[Function]

Specifying MaxiCode.

[Format](Setting part)

<2D20>,a(,bbb,ccc,d...d)

- Parameter

- a [Mode]

- 2 : Transportation (Numeric)
- 3 : Transportation (Alphanumeric)
- 4 : Standard symbol
- 6 : Reader programing

* Following parameter must be specified when specifying mode 2 or mode 3.

When specifying mode 4 or mode 6, the parameter should be omitted.

- b [Service class] = Valid Range : 001 to 999 (Numeric)
- c [Country code] = Valid Range : 001 to 999 (Numeric)
- d [Postal code] = Valid Range : 0 to 999999999 (Mode 2)
000000 to 999999 (Mode 3)

* Mode 2: Max 9 digits (Numeric only)

Mode 3: Fixed 6 digits (Capital alphabet)

[Format](Data part)

<DN>mmmm,n...n

- Parameter

m [Number of Data] = Valid Range : 1 to 138

n [Print data] = Data

* 00H cannot be specified.

Mode	Service class	Country code	Postal code	Maximum print data	
				Numeric only	Alphanumeric
2	Fixed 3 digits (Numeric only)	Fixed 3 digits (Numeric only)	Max. 9 digits	123	84
3			Fixed 6 digits (Alphanumeric)		
4	Omission			138	93
6					

[Coding Example]

Mode: Transportation (Numeric only), Service class: 003, Country code: 081, Postal code: 123456789

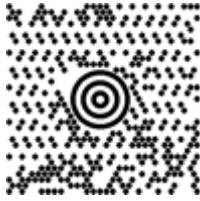

<A>
<V>100<H>200<2D20>2,003,081,123456789
<DN>0010,0123456789
<Q>2
<Z>

[Supplementary Explanation]

- Size of MaxiCode are not changed by number of data for printing.
- If parameter that is not described above is used, or number of print data does not match, symbol is not printed.
- When specifying mode 4 and mode 6, number of print data must be specified over 12. When number of print data is specified less than 11, scanner cannot read printed MaxiCode.
- The maximum number of print data varies depending on the print data combination when using the print data other than alphanumeric code.
- Barcode generation module has been modified for improvement. How the generated image looks may differ due to the change, however the read result is the same.

MaxiCode Code table

				S				I				S				O				
				B8	0	0	0	0	0	0	0	0	0	1	1	1	1	1	1	1
				B7	0	0	0	0	1	1	1	1	0	0	0	0	1	1	1	1
				B6	0	0	1	1	0	0	1	1	0	0	1	1	0	0	1	1
				B5	0	1	0	1	0	1	0	1	0	1	0	1	0	1	0	1
B4	B3	B2	B1		0	1	2	3	4	5	6	7	8	9	A	B	C	D	E	F
0	0	0	0	0			SP	0	@	P	`	p								
0	0	0	1	1			!	1	A	Q	a	q								
0	0	1	0	2			"	2	B	R	b	r								
0	0	1	1	3			#	3	C	S	c	s								
0	1	0	0	4			\$	4	D	T	d	t								
0	1	0	1	5			%	5	E	U	e	u								
0	1	1	0	6			&	6	F	V	f	v								
0	1	1	1	7			'	7	G	W	g	w								
1	0	0	0	8			(8	H	X	h	x								
1	0	0	1	9)	9	I	Y	i	y								
1	0	1	0	A			*	:	J	Z	j	z								
1	0	1	1	B			+	;	K	[k	{								
1	1	0	0	C			,	<	L	¥	l									
1	1	0	1	D			-	=	M]	m	}								
1	1	1	0	E			.	>	N	^	n	~								
1	1	1	1	F			/	?	O	_	o	DEL								

MaxiCode can specify from 01H to FFH.

[ESC+2D30] QR Code (Model 2)

Hexadecimal code	ESC	2D30	Parameter
	<1B> ₁₆	<32> ₁₆ <44> ₁₆ <33> ₁₆ <30> ₁₆	,a,bb,c,d(,ee,ff,gg)
Initial value	Nil		

Valid range and term of command	When the power is OFF	The set parameter is not maintained.
	Valid range within items	The set parameter becomes invalid.
	Valid range between items	The set parameter becomes invalid.

[Function]

Specifying QR Code (Model 2).

[Format] (Setup part)

<2D30>,a,bb,c,d(,ee,ff,gg)

- Parameter

- a [Error Correction Level]

- L : 7%
- M : 15%
- Q : 25%
- H : 30%

- b [Size of one side of cell] = Valid Range : 01 to 99 dots

- c [Data setup mode]

- 0 : Manual setup
- 1 : Automatic setup

* Note: You need to change the method of specifying print data with this setting.

- d [Concatenation mode]

- 0 : Normal mode
- 1 : Concatenation mode

Following parameter must be specified when specifying 1 (Concatenation mode) in Concatenation mode. Omit following parameter in normal mode.

- e [Number of partitions of concatenation mode] = Valid Range : 01 to 16

* Number of partitions: Specifying how many QR code are to be concatenated divided by Concatenation mode.

- f [Sequential number partitioned by concatenation mode] = Valid Range : 01 to 16

* Sequential number: Specifying what number is it of divided QR code.

- g [Concatenation mode parity data] = Valid Range : 00 to FF

* Parity data: Specifying exclusive OR of all the print data in divided QR code with HEX characters.

[Format] (Data part)

Manual setup (Data setup mode)

<DS>k,n...n : Use when input mode specification is Numeric mode, Alphanumeric mode and Kanji mode.

<DN>mmmm,n...n : Use when specifying by binary.

Automatic setup (Data setup mode)

<DN>mmmm,n...n : Change input mode automatically according to input data.

- Parameter

k [Input mode]

- 1 : Numeric mode
- 2 : Alphanumeric mode
- 3 : Kanji mode (Shift JIS Kanji)

* Specify only when specifying Manual setup in Data setting mode.

* There is binary specification other than above, but data specification command is different.

m [Number of data] = Valid Range : 1 to 2953

* Specify when specifying Automatic setup in Data setting mode or specifying binary specification in Manual setup.

n [Print data] = Data

[Format] (Version)

<QV>pp : Use when specifying the version.

- Parameter

pp [Version] = 00 to 40 (MODEL2)

* Use when fix the size of QR symbol by specifying the version. When not specified, it will be specified automatically. It will be Auto when specifying 00. The parameter error does not arise in the range from 00 to 40.

* Refer to [QR code version command] for details.

[Supplementary Explanation1]

- When specifying Kanji in <DN>, specify size that is 2 X number of Kanji characters.
- For <DN> in Automatic setup, when 80H to 9FH and E0H to FFH is specified as data, it is handed as Kanji mode, and cannot specify them as binary.

[Coding Example1]

Error correction level: 7%, Size of one side of cell: 05, Data setup mode: Manual setup, Concatenation mode: Normal



<A>

<V>100<H>200<2D30>,L,05,0,0

<DS>1,012345

<Q>2

<Z>

[Supplementary Explanation2]

- If the parameter other than the description is specified or number of print data does not match, printing is not performed.
- Data specification command in data part varies according to parameter setup or specified data.

[Coding Example2]

Error correction level: 7%, Size of one side of cell: 04, Mixed specification of Manual setup (Data setup mode)

In Manual setup, you can proceed specifying data in specified input mode (Numeric, Alphanumeric, Kanji, Binary).

<A>

<V>100<H>200

<2D30>,L,04,0,0

<DS>3,SATO

<DN>0010,0123456789

<DS>1,123

<Q>1
<Z>

[Supplementary Explanation3]

- Parameter part to be followed by Data part. Data part and data part should be specified in a row. When don't specify in a row, print result may not be secured.
- Total number of data (n) need to be less than 7000 bytes. Maximum number of blocks in data part specified in a row is 200.

[Coding Example 3]

Error correction level: 7%, Size of one side of cell: 05, Data setup mode: Manual setup,
Concatenation mode: Normal, Version 5

<A>
<V>100<H>200<2D30>,L,05,0,0
<QV>5
<DS>1,012345
<DN>0004,6789
<Q>1
<Z>

[Supplementary Explanation4]

- Specify <QV> command between <2Dxx> and <DN>/<DS>.
- When resulted in a parameter error, it will be handled in the same manner of no specification.
- It does not become a parameter error from 00 to 40 (Set the value within the range corresponding to each model).
For MODEL2, the setting range is from 00 to 40.
- Sending the data exceeding the data size of specified version will result in error and QR code is not printed.

QR Code data size list (Model 2)

Version	Error Correction	Numeric	Alpha-Numeric	Kanji	Binary
1 21 × 21	L	41	25	10	17
	M	34	20	8	14
	Q	27	16	7	11
	H	17	10	4	7
2 25 × 25	L	77	47	20	32
	M	63	38	16	26
	Q	48	29	12	20
	H	34	20	8	14
3 29 × 29	L	127	77	32	53
	M	101	61	26	42
	Q	77	47	20	32
	H	58	35	15	24
4 33 × 33	L	187	114	48	78
	M	149	90	38	62
	Q	111	67	28	46
	H	82	50	21	34
5 37 × 37	L	255	154	65	106
	M	202	122	52	84
	Q	144	87	37	60
	H	106	64	27	44
6 41 × 41	L	322	195	82	134
	M	255	154	65	106
	Q	178	108	45	74
	H	139	84	36	58
7 45 × 45	L	370	224	95	154
	M	293	178	75	122
	Q	207	125	53	86
	H	154	93	39	64
8 49 × 49	L	461	279	118	192
	M	365	221	93	152
	Q	259	157	66	108
	H	202	122	52	84
9 53 × 53	L	552	335	141	230
	M	432	262	111	180
	Q	312	189	80	130
	H	235	143	60	98
10 57 × 57	L	652	395	167	271
	M	513	311	131	213
	Q	364	221	93	151
	H	288	174	74	119

Version	Error Correction	Numeric	Alpha-Numeric	Kanji	Binary
11 61 × 61	L	772	468	198	321
	M	604	366	155	251
	Q	427	259	109	177
	H	331	200	85	137
12 65 × 65	L	883	535	226	367
	M	691	419	177	287
	Q	489	296	125	203
	H	374	227	96	155
13 69 × 69	L	1022	619	262	425
	M	796	483	204	331
	Q	580	352	149	241
	H	427	259	109	177
14 73 × 73	L	1101	667	282	458
	M	871	528	223	362
	Q	621	376	159	258
	H	468	283	120	194
15 77 × 77	L	1250	758	320	520
	M	991	600	254	412
	Q	703	426	180	292
	H	530	321	136	220
16 81 × 81	L	1408	854	361	586
	M	1082	656	277	450
	Q	775	470	198	322
	H	602	365	154	250
17 85 × 85	L	1548	938	397	644
	M	1212	734	310	504
	Q	876	531	224	364
	H	674	408	173	280
18 89 × 89	L	1725	1046	442	718
	M	1346	816	345	560
	Q	948	574	243	394
	H	746	452	191	310
19 93 × 93	L	1903	1153	488	792
	M	1500	909	384	624
	Q	1063	644	272	442
	H	813	493	208	338
20 97 × 97	L	2061	1249	528	858
	M	1600	970	410	666
	Q	1159	702	297	482
	H	919	557	235	382

Version	Error Correction	Numeric	Alpha-Numeric	Kanji	Binary
21 101 × 101	L	2232	1352	572	929
	M	1708	1035	438	711
	Q	1224	742	314	509
	H	969	587	248	403
22 105 × 105	L	2409	1460	618	1003
	M	1872	1134	480	779
	Q	1358	823	348	565
	H	1056	640	270	439
23 109 × 109	L	2620	1588	672	1091
	M	2059	1248	528	857
	Q	1468	890	376	611
	H	1108	672	284	461
24 113 × 113	L	2812	1704	721	1171
	M	2188	1326	561	911
	Q	1588	963	407	661
	H	1228	744	315	511
25 117 × 117	L	3057	1853	784	1273
	M	2395	1451	614	997
	Q	1718	1041	440	715
	H	1286	779	330	535
26 121 × 121	L	3283	1990	842	1367
	M	2544	1542	652	1059
	Q	1804	1094	462	751
	H	1425	864	365	593
27 125 × 125	L	3517	2132	902	1465
	M	2701	1637	692	1125
	Q	1933	1172	496	805
	H	1501	910	385	625
28 129 × 129	L	3669	2223	940	1528
	M	2857	1732	732	1190
	Q	2085	1263	534	868
	H	1581	958	405	658
29 133 × 133	L	3909	2369	1002	1628
	M	3035	1839	778	1264
	Q	2181	1322	559	908
	H	1677	1016	430	698
30 137 × 137	L	4158	2520	1066	1732
	M	3289	1994	843	1370
	Q	2358	1429	604	982
	H	1782	1080	457	742

Version	Error Correction	Numeric	Alpha-Numeric	Kanji	Binary
31 141 × 141	L	4417	2677	1132	1840
	M	3486	2113	894	1452
	Q	2473	1499	634	1030
	H	1897	1150	486	790
32 145 × 145	L	4686	2840	1201	1952
	M	3693	2238	947	1538
	Q	2670	1618	684	1112
	H	2022	1226	518	842
33 149 × 149	L	4965	3009	1273	2068
	M	3909	2369	1002	1628
	Q	2805	1700	719	1168
	H	2157	1307	553	898
34 153 × 153	L	5253	3183	1347	2188
	M	4134	2506	1060	1722
	Q	2949	1787	756	1228
	H	2301	1394	590	958
35 157 × 157	L	5529	3351	1417	2303
	M	4343	2632	1113	1809
	Q	3081	1867	790	1283
	H	2361	1431	605	983
36 161 × 161	L	5836	3537	1496	2431
	M	4588	2780	1176	1911
	Q	3244	1966	832	1351
	H	2524	1530	647	1051
37 165 × 165	L	6153	3729	1577	2563
	M	4775	2894	1224	1989
	Q	3417	2071	876	1423
	H	2625	1591	673	1093
38 169 × 169	L	6479	3927	1661	2699
	M	5039	3054	1292	2099
	Q	3599	2181	923	1499
	H	2735	1658	701	1139
39 173 × 173	L	6743	4087	1729	2809
	M	5313	3220	1362	2213
	Q	3791	2298	972	1579
	H	2927	1774	750	1219
40 177 × 177	L	7089	4296	1817	2953
	M	5596	3391	1435	2331
	Q	3993	2420	1024	1663
	H	3057	1852	784	1273

[ESC+2D31] QR Code (Model 1)

Hexadecimal code	ESC	2D31	Parameter
	<1B> ₁₆	<32> ₁₆ <44> ₁₆ <33> ₁₆ <31> ₁₆	,a,bb,c,d(,ee,ff,gg)
Initial value	Nil		

Valid range and term of command	When the power is OFF	The set parameter is not maintained.
	Valid range within item	The set parameter becomes invalid.
	Valid range between items	The set parameter becomes invalid.

[Function]

Specifying QR Code (Model 1).

[Format] (Setup part)

<2D31>,a,bb,c,d(,ee,ff,gg)

- Parameter

- a [Error Correction Level]

- L : 7%
- M : 15%
- Q : 25%
- H : 30%

- b [Size of one side of cell] = Valid Range : 01 to 99 dots

- c [Data setup mode]

- 0 : Manual setup
- 1 : Automatic setup

* Note: You need to change the method of specifying print data with this setting.

- d [Concatenation mode]

- 0 : Normal mode
- 1 : Concatenation mode

Following parameter must be specified when specifying 1 (Concatenation mode) in Concatenation mode. Omit following parameter in normal mode.

- e [Number of partitions of concatenation mode] = Valid Range : 01 to 16

* Number of partitions: Specifying how many QR code are to be concatenated divided by Concatenation mode.

- f [Sequential number partitioned by concatenation mode] = Valid Range : 01 to 16

* Sequential number: Specifying what number is it of divided QR code.

- g [Concatenation mode parity data] = Valid Range : 00 to FF

* Parity data: Specifying exclusive OR of all the print data in divided QR code with HEX characters.

[Format] (Data part)

Manual setup (Data setup mode)

<DS>k,n...n : Use when input mode specification is Numeric mode, Alphanumeric mode and Kanji mode.

<DN>mmmm,n...n : Use when specifying by binary.

Automatic setup (Data setup mode)

<DN>mmmm,n...n : Change input mode automatically according to input data.

- Parameter

k [Input mode]

- 1 : Numeric mode
- 2 : Alphanumeric mode
- 3 : Kanji mode (Shift JIS Kanji)

* Specify only when specifying Manual setup in Data setting mode.

* There is binary specification other than above, but data specification command is different.

m [Number of data] = Valid Range : 1 to 486

* Specify when specifying Automatic setup in Data setting mode or specifying binary specification in Manual setup.

n [Print data] = Data

[Format] (version)

<QV>pp : Specify when specifying the version.

- Parameter

pp [Version] = 00 to 14 (MODEL1)

* This setting is used when fixing the size of QR symbol with the version command. When not specified, it becomes Auto.

Specifying 00 also becomes Auto. It does not become a parameter error from 00 to 40.

* See [QR code version command] for details.

[Supplementary Explanation1]

- When specifying Kanji in <DN>, specify size that is 2 x number of Kanji characters.
- For <DN> in Automatic setup, when 80H to 9FH and E0H to FFH is specified as data, it is handed as Kanji mode, and cannot specify them as binary.

[Coding Example1]

Error correction level: 7%, Size of one side of cell: 05, Data setup mode: Manual setup, Concatenation mode: Normal



<A>

<V>100<H>200<2D31>,<L,05,0,0

<DS>1,012345

<Q>2

<Z>

[Supplementary Explanation2]

- If the parameter other than the description is specified or number of print data does not match, printing is not performed.
- Data specification command in data part varies according to parameter setup or specified data.

[Coding Example 2]

Error correction level: 7%, Size of one side of cell: 04, Mixed specification of Manual setup (Data setup mode)

In Manual setup, you can proceed specifying data in specified input mode (Numeric, Alphanumeric, Kanji, Binary).

```
<A>  
<V>100<H>200  
<2D31>,L,04,0,0  
<DS>3,SATO  
<DN>0010,0123456789  
<DS>1,123  
<Q>1  
<Z>
```

[Supplementary Explanation3]

- Parameter part to be followed by Data part. Data part and data part should be specified in a row. When do not specify in a row, print result may not be secured.

[Coding Example 3]

Error correction level: 7%, Size of one side of cell: 05, Data setup mode: Manual setup, Concatenation mode: Normal, Version 5

```
<A>  
<V>100<H>200<2D31>,L,05,0,0  
<QV>5  
<DS>1,012345  
<DN>0004,6789  
<Q>1  
<Z>
```

[Supplementary Explanation4]

- Specify <QV> command between <2Dxx> and <DN>/<DS>.
- When resulted in a parameter error, it will be handled in the same manner of no specification.
- It does not become a parameter error from 00 to 40 (Set the value within the range corresponding to each model).
Setting range(MODEL1): 00 to 14
- Sending the data exceeding the data size of specified version will result in error and QR code is not printed.

QR Code data size list (Model 1)

Version	Error Correction	Numeric	Alpha-numeric	Kanji	Binary	Version	Error Correction	Numeric	Alpha-numeric	Kanji	Binary
1 21×21	L	40	24	10	17	10 57×57	L	690	418	177	287
	M	33	20	8	14		M	526	319	135	219
	Q	25	15	6	11		Q	433	262	111	180
	H	16	10	4	7		H	291	176	74	121
2 25×25	L	81	49	20	34	11 61×61	L	800	485	205	333
	M	66	40	17	28		M	608	368	156	253
	Q	52	31	13	22		Q	493	299	126	205
	H	33	20	8	14		H	342	207	87	142
3 29×29	L	131	79	33	55	12 65×65	L	915	555	234	381
	M	100	60	25	42		M	694	421	178	289
	Q	81	49	20	34		Q	579	351	148	241
	H	52	31	13	22		H	390	236	100	162
4 33×33	L	186	113	48	78	13 69×69	L	1030	624	264	429
	M	138	84	35	58		M	790	479	202	329
	Q	114	69	29	48		Q	656	398	168	273
	H	76	46	19	32		H	454	275	116	189
5 37×37	L	253	154	65	106	14 73×73	L	1167	707	299	486
	M	191	116	49	80		M	877	531	225	365
	Q	157	95	40	66		Q	738	447	189	307
	H	105	63	27	44		H	498	302	127	207
6 41×41	L	321	194	82	134						
	M	249	151	64	104						
	Q	201	122	51	84						
	H	133	81	34	56						
7 45×45	L	402	244	103	168						
	M	311	188	80	130						
	Q	253	154	65	106						
	H	167	101	43	70						
8 49×49	L	493	299	126	206						
	M	378	229	97	158						
	Q	301	183	77	126						
	H	203	123	52	85						
9 53×53	L	585	354	150	244						
	M	441	267	113	184						
	Q	369	223	94	154						
	H	239	145	61	100						

[ESC+2D32] Micro QR Code

Hexadecimal code	ESC	2D32	Parameter
	<1B> ₁₆	<32> ₁₆ <44> ₁₆ <33> ₁₆ <32> ₁₆	,a,bb,c
Initial value	Nil		

Valid range and term of command	When the power is OFF	The set parameter is not maintained.
	Valid range within items	The set parameter becomes invalid.
	Valid range between items	The set parameter becomes invalid.

[Function]

Specifying QR Code (Micro QR Code).

[Format] (Setup part)

<2D32>,a,bb,c

- Parameter
 - a [Error Correction Level]
 - L : 7%
 - M : 15%
 - Q : 25%
 - b [Size of one side of cell] = Valid Range : 01 to 99 dots
 - c [Data setup mode]
 - 0 : Manual setup
 - 1 : Automatic setup

[Format] (Data part)

Manual setup (Data setup mode)

<DS>k,n...n : Use when input mode specification is Numeric mode, Alphanumeric mode and Kanji mode.

<DN>mmmm,n...n : Use when specifying by binary.

Automatic setup (Data setup mode)

<DN>mmmm,n...n : Change input mode automatically according to input data.

- Parameter
 - k [Input mode]
 - 1 : Numeric mode
 - 2 : Alphanumeric mode
 - 3 : Kanji mode (Shift JIS Kanji)

* There is binary specification other than above, but data specification command is different.
 - m [Number of data] = Valid Range : 1 to 15

* Specify when specifying Automatic setup in Data setting mode.
 - n [Print data] = Data

[Format] (version)

<QV>pp : Specify when specifying the version.

- Parameter

pp [Version] = 00 to 04 (MicroQR M1 to M4)

* This setting is used when fixing the size of QR symbol with the version command.
When not specified, it becomes Auto.

Specifying 00 also becomes Auto. It does not become a parameter error from 00 to 40.

* See [QR code version command] for details.

[Supplementary Explanation1]

- When specifying Kanji in <DN>, specify size that is 2 x number of Kanji characters.
- For <DN> in Automatic setup, when 80H to 9FH and E0H to FFH is specified as data, it is handed as Kanji mode, and cannot specify them as binary.

[Coding Example1]

Error correction level :7%, Size of one side of cell:04



<A>

<V>100<H>200<2D32>,L,04,0

<DS>1,012345

<Q>2

<Z>

[Supplementary Explanation2]

- If the parameter other than the description is specified or number of print data does not match, printing is not performed.
- Data specification command in data part varies according to parameter setup or specified data.

[Coding Example2]

Error correction level: 7%, Size of one side of cell: 04

Mixed specification of Manual setup (Data setup mode)

In Manual setup, you can proceed specifying data in specified input mode (Numeric, Alphanumeric, Kanji, Binary) in a row.

<A>

<V>100<H>200

<2D32>,L,04,0

<DS>3,SATO

<DN>0010,0123456789

<DS>1,123

<Q>1

<Z>

[Supplementary Explanation3]

- Parameter part to be followed by Data part. Data part and data part should be specified in a row. When do not specify in a row, print result may not be secured.

Micro QR Code Data size list

Version	Error correction	Numeric	Alphanumeric	Kanji	Binary
M1 (11x11)	L (Error detection only)	5	-	-	-
M2 (13x13)	L	10	6	-	-
	M	8	5	-	-
M3 (15x15)	L	23	14	6	9
	M	18	11	4	7
M4 (17x17)	L	35	21	9	15
	M	30	18	8	13
	Q	21	13	5	9

[Coding Example 3]

Error correction level: 7%, Size of one side of cell: 05, Data setup mode: Manual setup, Concatenation mode: Normal, printed in version M4

```
<A>
<V>100<H>200<2D32>,L,05,0,0
<QV>4
<DS>1,012345
<DN>0004,6789
<Q>1
<Z>
```

[Supplementary Explanation4]

- Specify <QV> command between <2Dxx> and <DN>/<DS>.
- When resulted in a parameter error, it will be handled in the same manner of no specification.
- It does not become a parameter error from 00 to 40 (Set the value within the range corresponding to each model).

For MicroQR, the setting range is from 00 to 04.

- Sending the data exceeding the data size of specified version will result in error and QR code is not printed.

[ESC+2D50] DataMatrix (ECC200)

Hexadecimal code	ESC	2D50	Parameter
	<1B> ₁₆	<32> ₁₆ <44> ₁₆ <35> ₁₆ <30> ₁₆	,aa,bb,ccc,ddd
Initial value	Nil		

Valid range and term of command	When the power is OFF	The set parameter is not maintained.
	Valid range within items	The set parameter becomes invalid.
	Valid range between items	The set parameter becomes invalid.

[Function]

Specifying DataMatrix Code (ECC200).

[Format] (Setup part)

<2D50>,aa,bb,ccc,ddd

- Parameter
 - a [Horizontal cell size] = Valid Range : 01 to 99 dots
 - b [Vertical cell size] = Valid Range : 01 to 99 dots
 - c [Number of cell in one line]
 - Valid Range : 010 to 144
 - 000 : (Auto-setting)
 - d [Number of cell lines]
 - Valid Range : 008 to 144
 - 000 : (Auto-setting)

[Format] (Data part)

<DN>mmmm,n...n

- Parameter
 - m [Number of data] = Valid Range : 1 to 3116
 - n [Print data] = Data
 - * When print 7EH, specify "7EH, 7EH"
 - * If Parameter other than above is specified or print data does not match, printing is not performed.

[Coding Example]

Horizontal cell size: 3 dots, Vertical cell size: 3 dots

```
<A>
<V>100<H>200<2D50>,03,03,000,000
<DN>0010,0123456789
<Z>
```

[Supplementary Explanation]

- If Parameter other than above is specified or print data do not match, printing is not performed.
- When specifying print format, secure more than 2 mm blank space in four sides of the DataMatrix for read margin for the scanner.
- When print data is 7EH, specify "7EH, 7EH". Number of data will be "0002".
- When Auto setup (000) is applied for [Number of cell in one row] and [Number of cell lines] , square DataMatrix is printed.
- The number of addressable data at data part is depending on data format. Following chart shows the number of addressable data (When the number of cell is set automatically or the maximum number of cell is specified).

	Data format	Number of data
Data format	Numeric	3116
	Alphanumeric	2335
	Binary (00H to FFH)	1556

- It is likely that symbol cannot be read by reducing the size of cell, which depends on the performance of scanner. In this case, it is required to specify the size of cell which is large enough for reading symbol.

* Symbol size of DataMatrix (ECC200) is following 30 types.

Symbol size and number of data of DataMatrix(ECC200)

	Symbol size			Maximum data digits		
	Number of cell in one line(c)	Number of cell line(d)	Number of block	Numeric	Alphanumeric	Briary
Square	10	10	1	6	3	1
	12	12	1	10	6	3
	14	14	1	16	10	6
	16	16	1	24	16	10
	18	18	1	36	25	16
	20	20	1	44	31	20
	22	22	1	60	43	28
	24	24	1	72	52	34
	26	26	1	88	64	42
	32	32	4	124	91	60
	36	36	4	172	127	84
	40	40	4	228	169	112
	44	44	4	288	214	142
	48	48	4	348	259	172
	52	52	4	408	304	202
	64	64	16	560	418	278
	72	72	16	736	550	366
	80	80	16	912	682	454
	88	88	16	1152	862	574
	96	96	16	1392	1042	694
104	104	16	1632	1222	814	
120	120	36	2100	1573	1048	
132	132	36	2608	1954	1302	
144	144	36	3116	2335	1556	
Rectangle	18	8	1	10	6	3
	32	8	2	20	13	8
	26	12	1	32	22	14
	36	12	2	44	31	20
	36	16	2	64	46	30
	48	16	2	98	72	47

* Mixture of Numeric, Alphanumeric and Control code varies according to number of characters.

DataMatrix Code table

				S	I	S	O															
				B8	0	0	0	0	0	0	0	0	1	1	1	1	1	1	1	1	1	1
				B7	0	0	0	0	1	1	1	1	0	0	0	0	1	1	1	1	1	1
				B6	0	0	1	1	0	0	1	1	0	0	1	1	0	0	1	1	1	1
				B5	0	1	0	1	0	1	0	1	0	1	0	1	0	1	0	1	0	1
B4	B3	B2	B1		0	1	2	3	4	5	6	7	8	9	A	B	C	D	E	F		
0	0	0	0	0			SP	0	@	P	`	p										
0	0	0	1	1			!	1	A	Q	a	q										
0	0	1	0	2			~	2	B	R	b	r										
0	0	1	1	3			#	3	C	S	c	s										
0	1	0	0	4			\$	4	D	T	d	t										
0	1	0	1	5			%	5	E	U	e	u										
0	1	1	0	6			&	6	F	V	f	v										
0	1	1	1	7			'	7	G	W	g	w										
1	0	0	0	8			(8	H	X	h	x										
1	0	0	1	9)	9	I	Y	i	y										
1	0	1	0	A			*	:	J	Z	j	z										
1	0	1	1	B			+	;	K	[k	{										
1	1	0	0	C			,	<	L	¥	l											
1	1	0	1	D			-	=	M]	m	}										
1	1	1	0	E			.	>	N	^	n	~										
1	1	1	1	F			/	?	O	_	o	DEL										

DataMatrix can specify from 00H to FFH.

When print 7EH, specify "7EH, 7EH".

[ESC+2D51] GS1 DataMatrix

Hexadecimal code	ESC	2D51	Parameter
	<1B> ₁₆	<32> ₁₆ <44> ₁₆ <35> ₁₆ <31> ₁₆	,aa,bb,ccc,ddd
Initial value	Nil		

Valid range and term of command	When the power is OFF	The set parameter is not maintained.
	Valid range within items	The set parameter becomes invalid.
	Valid range between items	The set parameter becomes invalid.

[Function]

Specifying GS1 DataMatrix Code.

[Format] (Setup part)

<2D51>,aa,bb,ccc,ddd

- Parameter
 - a [Horizontal cell size] = Valid Range : 01 to 99 dots
 - b [Vertical cell size] = Valid Range : 01 to 99 dots
 - c [Number of cell in one line]
 - Valid Range : 010 to 144
 - 000 : (Auto-setting)
 - d [Number of cell lines]
 - Valid Range : 008 to 144
 - 000 : (Auto-setting)

[Format] (Data part)

<DN>mmmm,n...n

- Parameter
 - m [Number of data] = Valid Range : 1 to 3116
 - n [Print data] = Data
 - * When print 7EH, specify [7EH, 7EH].
 - * When print 1BH, specify [1BH, 1BH].
 - * When print FNC1, specify [1BH, 31H].
 - * If Parameter other than above is specified or print data do not match, print is not secured.

[Coding Example]

Horizontal cell size: 3 dots, Vertical cell size: 3 dots

```
<A>
<V>100<H>200<2D51>,03,03,000,000
<DN>0014, <1B>161100123456789
<Q>2
<Z>
```

* <1B>₁₆ specifies character code "1BH".

[Supplementary Explanation]

- If Parameter other than above is specified or print data do not match, printing is not performed.
- When specifying print format, secure more than 2 mm blank space in four sides of the DataMatrix for read margin for the scanner.
- When print data is 7EH, specify [7EH, 7EH]. Number of data will be "0002".
- When [7EH] is specified solely, the command error occurs and the code will not be printed.
- When print data is 1BH, specify [1BH, 1BH]. Number of data will be "0002".
- When print data is FNC1, specify [1BH, 31H]. Number of data will be "0002".
- When [1BH] is specified solely, printing and the content of printing will not be guaranteed.
- When Auto setup (000) is applied for [Number of cell in one row] and [Number of cell lines], square DataMatrix is printed.
- When the same value other than 000 is specified (manual setting) in the "number of cell in one row" and "number of cell lines", square DataMatrix will be printed.
- When different value other than 000 is specified (manual setting) in the "number of cell in one row" and "number of cell lines", rectangle DataMatrix will be printed.
- The number of data can be specified in the data part depends on the data format. Available data number is as follows.

(Number of cell is auto setting or the maximum cell number is specified):

	Data format	Number of data
Data format	Numeric	3116
	Alphanumeric	2335
	Binary (00H to FFH)	1556

- The symbol may not be read by a scanner when the cell size is smaller. In the above case, specify enough cell size for the scanner.
- The symbol size available in the GS1 DataMatrix is limited to the 30 types in the below table. Also, the maximum number of data is limited depending on the symbol size. Refer to the "The maximum digit of the number of data" table.
- Make sure to specify 1BH and 31H at the beginning of the data.

Symbol size and number of data of GS1 DataMatrix.

	Symbol size			Maximum data digits		
	Number of cell in one line(c)	Number of cell line(d)	Number of block	Numeric	Alphanumeric	Briary
Square	10	10	1	6	3	1
	12	12	1	10	6	3
	14	14	1	16	10	6
	16	16	1	24	16	10
	18	18	1	36	25	16
	20	20	1	44	31	20
	22	22	1	60	43	28
	24	24	1	72	52	34
	26	26	1	88	64	42
	32	32	4	124	91	60
	36	36	4	172	127	84
	40	40	4	228	169	112
	44	44	4	288	214	142
	48	48	4	348	259	172
	52	52	4	408	304	202
	64	64	16	560	418	278
	72	72	16	736	550	366
	80	80	16	912	682	454
	88	88	16	1152	862	574
	96	96	16	1392	1042	694
104	104	16	1632	1222	814	
120	120	36	2100	1573	1048	
132	132	36	2608	1954	1302	
144	144	36	3116	2335	1556	
Rectangle	18	8	1	10	6	3
	32	8	2	20	13	8
	26	12	1	32	22	14
	36	12	2	44	31	20
	36	16	2	64	46	30
	48	16	2	98	72	47

* Mixture of Numeric, Alphanumeric and Control code varies according to number of characters.

GS1 DataMatrix Code table

				S				I				S				O					
				B8	0	0	0	0	0	0	0	0	0	1	1	1	1	1	1	1	1
				B7	0	0	0	0	1	1	1	1	0	0	0	0	1	1	1	1	1
				B6	0	0	1	1	0	0	1	1	0	0	1	1	0	0	1	1	1
				B5	0	1	0	1	0	1	0	1	0	1	0	1	0	1	0	1	1
B4	B3	B2	B1		0	1	2	3	4	5	6	7	8	9	A	B	C	D	E	F	
0	0	0	0	0			SP	0	@	P	`	p									
0	0	0	1	1			!	1	A	Q	a	q									
0	0	1	0	2			"	2	B	R	b	r									
0	0	1	1	3			#	3	C	S	c	s									
0	1	0	0	4			\$	4	D	T	d	t									
0	1	0	1	5			%	5	E	U	e	u									
0	1	1	0	6			&	6	F	V	f	v									
0	1	1	1	7			'	7	G	W	g	w									
1	0	0	0	8			(8	H	X	h	x									
1	0	0	1	9)	9	I	Y	i	y									
1	0	1	0	A			*	:	J	Z	j	z									
1	0	1	1	B			+	;	K	[k	{									
1	1	0	0	C			,	<	L	¥	l										
1	1	0	1	D			-	=	M]	m	}									
1	1	1	0	E			.	>	N	^	n	~									
1	1	1	1	F			/	?	O	_	o	DEL									

	Data n	Data n+1
FNC1	1BH	31H

GS1 DataMatrix can specify from 00H to FFH.

When print data is 7EH, specify [7EH, 7EH].

When print data is 1BH, specify [1BH, 1BH].

When specifying FNC1, specify [1BH, 31H].

[ESC+2D70] Aztec Code

Hexadecimal code	ESC	2D70	Parameter
	<1B> ₁₆	<32> ₁₆ <44> ₁₆ <37> ₁₆ <30> ₁₆	,a,bb,cc,dd,e,f...f
Initial value	Nil		

Valid range and term of command	When the power is OFF	The set parameter is not maintained.
	Valid range within items	The set parameter becomes invalid.
	Valid range between items	The set parameter becomes invalid.

[Function]

Specifies Aztec Code.

[Format] (Setup part)

<2D70>,a,bb,cc,dd,e,f...f

- Parameter
 - a [Symbol Type]
 - 0 : Full Range Symbol
 - 1 : Compact Symbol
 - b [ECC Percentage]
 - 0 : Default error correction level
 - 01 to 99 : Error correction percentage
 - c [Symbol Size]
 - 0 : Automatic minimization
 - 1 to 4 : 1 to 4 – layer (Compact Symbol) * Following symbol size table reference.
 - 4 to 32 : 4 to 32 – layer (Full Range Symbol) * Following symbol size table reference.
 - d [Number of symbols for structured append]
 - 0 : Encodes without append
 - 1 : Automatic Setting
 - 2 to 26 : Append structured blocks
 - e [Message ID]
 - Y : Specify Message ID for structured bound symbol
 - N : No Message ID
 - f [Message ID for structured bound symbol]
 - Printable ASCII string (0x21 to 0x7E) with maximum 24 bytes.

[Format] (Data part)

<DS>n..n // for ASCII data

<DN>mmmm,n..n // for Binary data

- Parameter
 - m [Number of Data] = 0001 to 1914
 - Set this parameter when Print data are in Binary.
 - n [Print data] = Data
 - When selecting [1BH], make sure to specify [1BH,1BH].
 - When selecting [FNC1], make sure to specify [1BH,30H]
 - When selecting [ECI], make sure to specify [1BH,*]. (** refers from 31H to 36H.)

[Coding Example]

Symbol Type: Compact, ECC Percentage: Default, Symbol Size: 2 layer, Structured Append: Without append, Message ID: No, Message ID for structured bound symbol: None, Barcode Data: THIS IS TEST.

```
<A>  
<V>0100<H>0100<L>0404  
<2D70>,1,0,2,0,N,<DS>THIS IS TEST  
<Q>1  
<Z>
```

- Generated Label



[Notes]

- When parameters other than the description are specified, symbol may not print.
- When the size of the Aztec code is small, the symbol might not be able to read according to the performance of the scanner. In that case, please magnify the size of the symbol to make it large enough by using <ESC>+L command maintaining the same ratio of magnification for both length and width.
- The smallest symbol size is 15x15 modules and largest is 151x151 modules. Available Aztec code formats and its maximum capacity are as follows:

Symbol size table

Parameter c	Format	Digit	Text	Binary data
1	15x15 Compact	13	12	6
2	19x19 Compact	40	33	19
3	23X23 Compact	70	57	33
4	27X27 Compact	110	89	53
4	31X31	128	104	62
5	37X37	178	144	87
6	41X41	232	187	114
7	45X45	294	236	145
8	49X49	362	291	179
9	53X53	433	348	214
10	57X57	516	414	256
11	61X61	601	482	298
12	67X67	691	554	343
13	71X71	793	636	394
14	75X75	896	718	446
15	79X79	1008	808	502
16	83X83	1123	900	559
17	87X87	1246	998	621

Parameter c	Format	Digit	Text	Binary data
18	91X91	1378	1104	687
19	95X95	1511	1210	753
20	101X101	1653	1324	824
21	105X105	1801	1442	898
22	109X109	1956	1566	976
23	113X113	2116	1694	1056
24	117X117	2281	1826	1138
25	121X121	2452	1963	1224
26	125X125	2632	2107	1314
27	131X131	2818	2256	1407
28	135X135	3007	2407	1501
29	139X139	3205	2565	1600
30	143X143	3409	2728	1702
31	147X147	3616	2894	1806
32	151X151	3832	3067	1914

- Aztec code is settable within the range (00H – FFH). For Binary data, user needs to set the data number properly by using the <ESC>DN command. If Data number and Print data does not match, symbol will not print properly.
- When print data is [1BH], specify [1BH,1BH]. Data number becomes [0002].
- Use [1BH,*] in pairs within input data when presenting ECI. "*" must be a value between 31H and 36H. The number in the following FLG(1) - FLG(6) are the number of digits of the data to be used for ECI.

<ESC>1→FLG(1) The number of digits specified for ECI data is 1 digit.

<ESC>2→FLG(2) The number of digits specified for ECI data is 2 digits.

<ESC>3→FLG(3) The number of digits specified for ECI data is 3 digits.

<ESC>4→FLG(4) The number of digits specified for ECI data is 4 digits.

<ESC>5→FLG(5) The number of digits specified for ECI data is 5 digits.

<ESC>6→FLG(6) The number of digits specified for ECI data is 6 digits.

e.g.)A sample data with <ESC>4 : <ESC>41111ABCDE

The scanned data when <ESC>4 will be "\001111ABCDE" ('\ may differ depending on scanner settings).

1) <ESC>4 means FLG(4). The succeeding "1111"(4 digits) will be treated as ECI data.

2) Since it is short by 2 digits, 0 is padded in the beginning to make it "\001111".

- The message ID is enabled only when it is separated to print after automatic setting with "Number of symbols for structured append" with specifying "Append structured blocks".

Aztec Code Table

					S				I				S				O						
					b8	0	0	0	0	0	0	0	0	0	1	1	1	1	1	1	1	1	
					b7	0	0	0	0	1	1	1	1	1	0	0	0	0	1	1	1	1	
					b6	0	0	1	1	0	0	1	1	1	0	0	1	1	0	0	1	1	
					b5	0	1	0	1	0	1	0	1	0	1	0	1	0	1	0	1	0	1
B4	b3	b2	b1		0	1	2	3	4	5	6	7	8	9	A	B	C	D	E	F			
0	0	0	0	0			SP	0	@	P	`	p											
0	0	0	1	1			!	1	A	Q	a	q											
0	0	1	0	2			"	2	B	R	b	r											
0	0	1	1	3			#	3	C	S	c	s											
0	1	0	0	4			\$	4	D	T	d	t											
0	1	0	1	5			%	5	E	U	e	u											
0	1	1	0	6			&	6	F	V	f	v											
0	1	1	1	7			'	7	G	W	g	w											
1	0	0	0	8			(8	H	X	h	x											
1	0	0	1	9)	9	I	Y	i	y											
1	0	1	0	A			*	:	J	Z	j	z											
1	0	1	1	B			+	;	K	[k	{											
1	1	0	0	C			,	<	L	\	l												
1	1	0	1	D			-	=	M]	m	}											
1	1	1	0	E			.	>	N	^	n	~											
1	1	1	1	F			/	?	O	_	o	DEL											

	Data n	Data n+1
FNC1	1BH	30H
ECI	1BH	31H to 36H

Aztec code is settable within the range (00H – FFH).

To set 1BH, specify [1BH,1BH]

To set FNC1, specify [1BH, 30H].

[ESC+BQ] QR Code (Compatible command)

Hexadecimal code	ESC	BQ	Parameter
	<1B> ₁₆	<42> ₁₆ <51> ₁₆	Manual setup: abcc, (ddeeff,)g(hhhh)n Auto setup: abcc,(ddeeff,)gn
Initial value	Nil		

Valid range and term of command	When the power is OFF	The set parameter is not maintained.
	Valid range within items	The set parameter becomes invalid.
	Valid range between items	The set parameter becomes invalid.

[Function]

Specifying QR code.

[Format]

[Manual setup] <BQ>abcc,(ddeeff,)g(hhhh)n

[Auto setup] <BQ>abcc,(ddeeff,)0n

- Parameter

- a [Error correction level]
 - 1 : 7% High density level (L)
 - 2 : 15% Standard level (M)
 - 3 : 30% High reliability level (H)
 - 4 : 15% High reliability level (Q)
- b [Concatenation mode]
 - 0 : Normal mode
 - 1 : Concatenation mode
- c [Size of one side of cell]
 - Valid Range : 01 to 99 (dot)
 - e.x.) cc=04

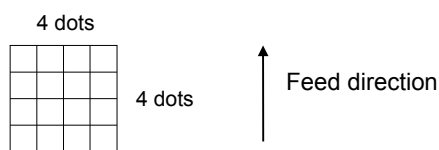

- d [No. of partitions by concatenation mode]
 - Valid range : 01 to 16
- e [Sequential number partitioned by concatenation mode]
 - Valid range : 01 to 16
- f [Concatenation mode parity data]
 - Valid range : 00 to FF
- g [Character mode]
 - 0 : Auto setup mode
 - 1 : Number mode
 - 2 : Alphanumeric mode
 - 3 : Binary mode
 - 4 : Kanji mode
- h [No. of data]
 - Valid range : 0001 to 7366 (dot)
- n [Print data] = Data

[Coding Example]

Error correction level: 30%, Concatenation mode: Normal, Size of one side of cell: 10

<A>

<V>100<H>200<BQ>3010,112345

<Q>2

<Z>

[Supplementary Explanation]

- Carry out XOR logic operation of all the partitioned print data of the QR code and then, specify this operation data in hexadecimal character. This is what we call [Parity data].
- When character mode is set to other than binary mode, it is not necessary to set data number parameter.

[Precautions during use]

- This is the command of MB2i series. Recommend the use of <2D31>.

QR Code data size list (Model 1)

Version	Error Correction	Numeric	Alpha-numeric	Kanji	Binary	Version	Error Correction	Numeric	Alpha-numeric	Kanji	Binary
1 21×21	L	40	24	10	17	10 57×57	L	690	418	177	287
	M	33	20	8	14		M	526	319	135	219
	Q	25	15	6	11		Q	433	262	111	180
	H	16	10	4	7		H	291	176	74	121
2 25×25	L	81	49	20	34	11 61×61	L	800	485	205	333
	M	66	40	17	28		M	608	368	156	253
	Q	52	31	13	22		Q	493	299	126	205
	H	33	20	8	14		H	342	207	87	142
3 29×29	L	131	79	33	55	12 65×65	L	915	555	234	381
	M	100	60	25	42		M	694	421	178	289
	Q	81	49	20	34		Q	579	351	148	241
	H	52	31	13	22		H	390	236	100	162
4 33×33	L	186	113	48	78	13 69×69	L	1030	624	264	429
	M	138	84	35	58		M	790	479	202	329
	Q	114	69	29	48		Q	656	398	168	273
	H	76	46	19	32		H	454	275	116	189
5 37×37	L	253	154	65	106	14 73×73	L	1167	707	299	486
	M	191	116	49	80		M	877	531	225	365
	Q	157	95	40	66		Q	738	447	189	307
	H	105	63	27	44		H	498	302	127	207
6 41×41	L	321	194	82	134						
	M	249	151	64	104						
	Q	201	122	51	84						
	H	133	81	34	56						
7 45×45	L	402	244	103	168						
	M	311	188	80	130						
	Q	253	154	65	106						
	H	167	101	43	70						
8 49×49	L	493	299	126	206						
	M	378	229	97	158						
	Q	301	183	77	126						
	H	203	123	52	85						
9 53×53	L	585	354	150	244						
	M	441	267	113	184						
	Q	369	223	94	154						
	H	239	145	61	100						

QR Code (Numeric mode) Code table

				S				I				S				0				
				B8	0	0	0	0	0	0	0	0	1	1	1	1	1	1	1	1
				B7	0	0	0	0	1	1	1	1	0	0	0	0	1	1	1	1
				B6	0	0	1	1	0	0	1	1	0	0	1	1	0	0	1	1
				B5	0	1	0	1	0	1	0	1	0	1	0	1	0	1	0	1
B4	B3	B2	B1		0	1	2	3	4	5	6	7	8	9	A	B	C	D	E	F
0	0	0	0	0				0												
0	0	0	1	1				1												
0	0	1	0	2				2												
0	0	1	1	3				3												
0	1	0	0	4				4												
0	1	0	1	5				5												
0	1	1	0	6				6												
0	1	1	1	7				7												
1	0	0	0	8				8												
1	0	0	1	9				9												
1	0	1	0	A																
1	0	1	1	B																
1	1	0	0	C																
1	1	0	1	D																
1	1	1	0	E																
1	1	1	1	F																

QR Code (Alphanumeric mode) Code table

				S				I				S				0				
				B8	0	0	0	0	0	0	0	0	1	1	1	1	1	1	1	1
				B7	0	0	0	0	1	1	1	1	0	0	0	0	1	1	1	1
				B6	0	0	1	1	0	0	1	1	0	0	1	1	0	0	1	1
				B5	0	1	0	1	0	1	0	1	0	1	0	1	0	1	0	1
B4	B3	B2	B1		0	1	2	3	4	5	6	7	8	9	A	B	C	D	E	F
0	0	0	0	0			SP	0		P										
0	0	0	1	1				1	A	Q										
0	0	1	0	2				2	B	R										
0	0	1	1	3				3	C	S										
0	1	0	0	4			\$	4	D	T										
0	1	0	1	5			%	5	E	U										
0	1	1	0	6				6	F	V										
0	1	1	1	7				7	G	W										
1	0	0	0	8				8	H	X										
1	0	0	1	9				9	I	Y										
1	0	1	0	A			*	:	J	Z										
1	0	1	1	B			+		K											
1	1	0	0	C					L											
1	1	0	1	D			-		M											
1	1	1	0	E			.		N											
1	1	1	1	F			/		O											

QR Code (Binary mode) Code table

				S				I				S				0				
				B8	0	0	0	0	0	0	0	0	1	1	1	1	1	1	1	1
				B7	0	0	0	0	1	1	1	1	0	0	0	0	1	1	1	1
				B6	0	0	1	1	0	0	1	1	0	0	1	1	0	0	1	1
				B5	0	1	0	1	0	1	0	1	0	1	0	1	0	1	0	1
B4	B3	B2	B1	0	1	2	3	4	5	6	7	8	9	A	B	C	D	E	F	
0	0	0	0	0		SP	0	@	P	`	p									
0	0	0	1	1		!	1	A	Q	a	q									
0	0	1	0	2		~	2	B	R	b	r									
0	0	1	1	3		#	3	C	S	c	s									
0	1	0	0	4		\$	4	D	T	d	t									
0	1	0	1	5		%	5	E	U	e	u									
0	1	1	0	6		&	6	F	V	f	v									
0	1	1	1	7		'	7	G	W	g	w									
1	0	0	0	8		(8	H	X	h	x									
1	0	0	1	9)	9	I	Y	i	y									
1	0	1	0	A		*	:	J	Z	j	z									
1	0	1	1	B		+	;	K	[k	[
1	1	0	0	C		,	<	L	¥	l										
1	1	0	1	D		-	=	M]	m	}									
1	1	1	0	E		.	>	N	^	n	~									
1	1	1	1	F		/	?	O	_	o	DEL									

QR Code can specify from 00H to 7FH, and from A0H to DFH.

QR Code (Kanji mode) Code table

	Shift JIS	0	1	2	3	4	5	6	7	8	9	A	B	C	D	E	F
記号	813F	SP	、	。	、	。	。	。	。	:	?	!	^	^	^	^	^
	814F	^	—	—	、	<	>	≠	//	全	々	×	○	—	—	—	/
	815F	\	~	//		…	…	′	′	“	”	()	[]	[]
	816F	{	}	<	>	《	》	「	」	『	』	【	】	+	-	±	×
	8180	÷	=	≠	<	>	≤	≥	∞	∴	♂	♀	*	′	”	°	¥
	8190	\$	¢	£	%	#	&	*	@	§	☆	★	○	●	◎	◇	
	819E	◆	□	■	△	▲	▽	▼	※	〒	→	←	↑	↓	=		
英・数字	824F	0	1	2	3	4	5	6	7	8	9						
	825F	A	B	C	D	E	F	G	H	I	J	K	L	M	N	O	
	826F	P	Q	R	S	T	U	V	W	X	Y	Z					
	8280	a	b	c	d	e	f	g	h	i	j	k	l	m	n	o	
	8290	p	q	r	s	t	u	v	w	x	y	z					
ひらがな	829E	あ	い	う	え	お	か	が	き	ぎ	く						
	82AE	ぐ	け	げ	こ	ご	さ	ざ	し	じ	ず	せ	ぜ	そ	ぞ	た	
	82BE	だ	ち	ち	っ	つ	づ	て	で	と	ど	な	に	ぬ	ね	の	は
	82CE	ば	ば	ひ	び	び	ふ	ぶ	ぶ	へ	べ	べ	ほ	ほ	ほ	ま	み
	82DE	む	め	も	や	や	ゆ	ゆ	よ	よ	ら	り	る	れ	ろ	わ	わ
	82EE	ゐ	ゑ	を	ん												
カタカナ	833F	ア	イ	ウ	エ	オ	カ	ガ	キ	ギ	ク						
	834F	グ	ケ	ゲ	コ	ゴ	サ	ザ	シ	ジ	ズ	セ	ゼ	ソ	ゾ	タ	
	835F	ダ	チ	ヂ	ツ	ヅ	テ	デ	ト	ド	ナ	ニ	ヌ	ネ	ノ	ハ	
	836F	バ	バ	ヒ	ビ	ビ	フ	ブ	ブ	ヘ	ベ	ベ	ホ	ポ	ポ	マ	ミ
	8380	ム	メ	モ	ヤ	ヤ	ユ	ユ	ヨ	ヨ	ラ	リ	ル	レ	ロ	ワ	ワ
	8390	ヰ	ヱ	ヲ	ン	ヅ	カ	ケ									
ギリシア文字	839E	A	B	Γ	Δ	E	Z	H	Θ	I	K	Λ	M	N	Ξ	O	
	83AE	Π	P	Σ	T	Υ	Φ	X	Ψ	Ω							
	83BE	α	β	γ	δ	ε	ζ	η	θ	ι	κ	λ	μ	ν	ξ	ο	
	83CE	π	ρ	σ	τ	υ	φ	χ	ψ	ω							
ロシア文字	843F	A	B	B	Г	Д	E	Ё	Ж	З	И	Й	К	Л	М	Н	
	844F	О	П	Р	С	Т	У	Ф	Х	Ц	Ч	Ш	Щ	Ъ	Ы	Ь	Э
	845F	Ю	Я														
	846F	a	b	b	Г	Д	E	Ё	Ж	З	И	Й	К	Л	М	Н	
	8480	о	п	р	с	т	у	ф	х	ц	ч	ш	щ	ъ	ы	ь	э
	8490	ю	я														

	Shift JIS	0	1	2	3	4	5	6	7	8	9	A	B	C	D	E	F	
ア	889E		垂	啞	娃	阿	哀	愛	挨	始	逢	葵	茜	穉	惡	握	漚	
	88AE		旭	葦	鯉	梓	任	幹	扱	宛	姐	虻	鉛	絢	綾	鮎	或	
	88BE		粟	裕	安	庵	按	暗	案	闇	鞍	杏						
イ	88BE											以	伊	位	依	偉	困	
	88CE		夷	委	威	尉	惟	意	慰	易	椅	為	畏	異	移	維	緯	胃
	88DE		萎	衣	謂	違	遺	医	井	亥	域	育	郁	礎	一	杏	溢	逸
	88EE		稻	茨	芋	鋤	允	印	咽	員	因	姻	引	飲	淫	胤	蔭	
	893F																	
ウ	893F							右	宇	烏	羽	迂	雨	卯	鷄	窺	丑	
	894F		碓	臼	渦	嘘	唄	嶺	蔚	姥	厥	浦	瓜	閨	啤	云	運	
	895F		雲															
エ	895F		荏	餌	叡	營	嬰	影	映	曳	榮	永	冰	洩	瑛	盈	穎	
	896F		穎	英	衛	詠	銳	液	疫	益	駅	悅	謁	越	閨	榎	厭	円
	8980		園	堰	奄	宴	延	怨	掩	援	沿	演	炎	焰	煙	燕	猿	綠
	8990		艶	苑	園	遠	鉛	鸞	塩									
オ	8990								於	汚	甥	凹	央	奧	往	応		
	899E			押	旺	横	欧	殴	王	翁	換	鶯	鷓	黃	岡	沖	荻	徳
	89AE		屋	億	臆	桶	杜	乙	俺	卸	恩	温	穩	音				
カ	89AE													下	化	仮	何	
	89BE		伽	伽	佳	加	可	嘉	夏	嫁	家	寡	科	暇	果	架	歌	河
	89CE		火	珂	禍	禾	稼	箇	花	苛	茄	荷	華	菓	蝦	課	嘩	貨
	89DE		迦	過	霞	蚊	俄	峨	我	牙	画	臥	芽	蛾	賀	雅	餓	駕
	89EE		介	会	解	回	塊	壞	迴	快	怪	悔	恢	懷	戒	拐	改	
	8A3F			魁	晦	械	海	灰	界	皆	繪	芥	蟹	開	階	貝	凱	劾
	8A4F		外	咳	害	崖	慨	概	涯	碍	蓋	街	該	鐘	骸	淫	馨	蛙
	8A5F		垣	柿	蛎	鈎	劃	嚇	各	廓	搨	挽	格	核	殼	獲	確	穫
	8A6F		覚	角	赫	較	郭	闊	隔	革	学	岳	樂	額	頤	掛	笠	徑
	8A80		權	棍	歛	渴	割	喝	恰	括	活	渴	滑	葛	褐	轄	且	鯉
	8A90		叶	柁	棒	靴	株	兜	甕	蒲	釜	鎌	嗜	鴨	栢	茅	萱	
	8A9E			粥	刈	苜	瓦	乾	侃	冠	寒	刊	勸	勸	卷	喚	堪	姦
	8AAE		完	官	寬	干	幹	患	感	慣	憾	換	敢	柑	桓	棺	款	款
	8ABE		汗	漢	澗	灌	環	甘	監	看	竿	管	簡	緩	缶	翰	肝	艦
	8ACE		莞	觀	諫	貫	還	鑑	間	閑	閑	陷	韓	館	館	丸	含	岸
	8ADE		巖	玩	瘡	眼	岩	翫	廣	雁	頑	頑	顛					

	Shift JIS	0	1	2	3	4	5	6	7	8	9	A	B	C	D	E	F
キ	8ADE												企	伎	危	喜	器
	8AEE	基	奇	嬉	寄	岐	希	幾	忌	揮	机	旗	既	期	棋	棄	
	8B3F		機	婦	較	氣	汽	畿	折	季	稀	紀	微	規	記	貴	起
	8B4F	軌	輝	飢	騎	鬼	龜	偽	儀	妓	宜	戲	技	擬	欺	備	疑
	8B5F	祇	義	蟻	誼	讓	掬	菊	鞠	吉	吃	喫	桔	橘	詰	砧	杵
	8B6F	黍	却	客	脚	虐	逆	丘	久	仇	休	及	吸	宮	弓	急	救
	8B80	朽	求	汲	泣	灸	球	究	窮	笈	級	糾	給	旧	牛	去	居
	8B90	巨	拒	搥	拳	渠	虛	許	距	鋸	漁	翼	魚	亨	享	京	
	8B9E		供	俠	僞	兇	競	共	凶	協	匡	卿	叫	喬	境	峽	強
	8BAE	彊	怯	恐	恭	挾	教	橋	況	狂	狹	矯	胸	脅	興	蕎	鄉
	8BBE	鏡	響	響	驚	仰	凝	亮	曉	業	局	曲	極	玉	桐	籽	僅
	8BCE	勳	均	巾	錦	斤	欣	飲	琴	禁	禽	筋	緊	芹	菌	衿	襟
	8BDE	謹	近	金	吟	銀											
ク	8BDE					九	俱	句	区	狗	玖	矩	苦	軀	驅	駁	
	8BEE	駒	具	愚	虞	喰	空	偶	寓	遇	隅	串	柳	鉏	屑	屈	
	8C3F		掘	窟	沓	靴	嚮	窪	隈	桑	栗	繰	桑	嫩	煎	君	
	8C4F	薫	訓	群	軍	郡											
ケ	8C4F					卦	袞	祁	係	傾	刑	兄	啓	圭	珪	型	
	8C5F	契	形	徑	惠	慶	慧	憩	携	敬	景	桂	涇	畦	稽	系	
	8C6F	經	繼	繫	霽	莖	荊	螢	詣	警	輕	頸	鷄	莖	迎	鯨	
	8C80	劇	戟	擊	激	隙	析	傑	決	深	穴	結	血	訣	月	件	
	8C90	儉	倦	健	兼	券	劍	喧	堅	嫌	建	憲	懸	拳	捲		
	8C9E		檢	權	牽	犬	獻	研	綱	巢	肩	見	謙	賢	軒	遣	
	8CAE	鍵	險	顯	驗	鯨	元	原	幻	弦	減	源	玄	現	絃	絃	
	8CBE	言	諺	限													
コ	8CBE				乎	個	古	呼	固	姑	孤	己	庫	孤	戸	故	枯
	8CCE	湖	狐	糊	袴	股	胡	菰	虎	誇	跨	鈷	雇	顧	鼓	互	
	8CDE	伍	午	吳	吾	娛	後	御	悟	梧	楠	瑚	暮	語	誤	護	
	8DEE	乞	鯉	交	佼	侯	候	倖	光	公	功	効	勾	厚	口	向	
	8D3F		后	喉	坑	垢	好	孔	孝	宏	工	巧	巷	幸	広	庚	
	8D4F	弘	恒	慌	抗	拘	控	攻	昂	晃	更	杭	校	梗	構	江	
	8D5F	浩	港	溝	甲	皇	硬	稿	糠	紅	缸	絞	綱	耕	考	肯	
	8D6F	腔	膏	航	荒	行	衡	講	貢	購	郊	醉	鉦	砧	鋼	閏	
	8D80	頃	香	高	鴻	剛	劫	号	合	壕	拷	濠	豪	轟	趨	克	刻

	Shift JIS	0	1	2	3	4	5	6	7	8	9	A	B	C	D	E	F
コ	8D90	告	国	殺	酷	饒	黒	獄	渡	腰	甌	忽	惚	骨	拍	込	
	8D9E		此	頃	今	困	坤	壘	婚	恨	懇	昏	昆	根	梱	混	痕
	8DAE	紺	良	魂													
サ	8DAE			些	佐	又	唆	嵯	左	差	查	沙	瑛	砂	詐	鎖	
	8DBE	裝	坐	座	挫	價	催	再	哉	塞	妻	宰	彩	才	採	裁	
	8DCE	歳	濟	災	采	厚	碎	碧	斎	細	菜	裁	載	際	劑	在	
	8DDE	材	罪	財	冴	坂	阪	堺	肴	咲	崎	埼	碕	鷺	作	削	
	8DEE	昨	榨	昨	朔	權	窄	策	錯	桜	鮭	笹	匙	冊	刷		
	8E3F		察	抄	撮	擦	札	殺	雜	卓	鯖	捌	鑄	餃	皿	晒	
	8E4F	三	傘	參	山	慘	撒	散	燦	珊	産	算	纂	蛭	讚	贊	
8E5F	酸	餐	斬	暫	殘												
シ	8E5F					仕	仔	伺	使	刺	司	史	嗣	四	士	始	
	8E6F	姉	姿	子	屍	市	師	志	指	支	孜	斯	施	旨	枝	止	
	8E80	死	氏	獅	祉	私	糸	紙	肢	脂	至	視	詞	詩	試	誌	
	8E90	語	資	陽	雌	飼	齒	事	侍	児	字	寺	慈	持	時		
	8E9E		次	滋	治	爾	聖	痔	示	而	耳	自	蒔	薛	汐	鹿	
	8EAE	式	識	曉	竺	軸	穴	零	叱	執	失	嫉	室	悉	濕	漆	
	8EBE	疾	買	実	節	篠	悃	柴	屢	茲	縞	舍	写	射	捨	散	
	8ECE	斜	煮	社	紗	者	謝	車	蛇	邪	借	勺	尺	杓	灼	爵	
	8EDE	酌	釈	錫	若	寂	弱	惹	取	守	手	朱	殊	狩	珠	種	
	8EEE	腫	趣	酒	首	儒	受	呪	授	樹	綬	需	囚	収	周		
	8F3F		宗	就	州	修	愁	拾	秀	秋	終	續	習	臭	舟	蒐	
	8F4F	衆	襲	誓	獸	輯	週	酋	集	醜	什	住	充	十	從	戎	
	8F5F	柔	汁	洪	獸	纒	重	銃	夙	宿	淑	祝	縮	肅	塾	熟	
	8F6F	出	術	述	俊	峻	春	瞬	舜	駿	准	循	旬	楯	殉	淳	
	8F80	準	潤	盾	純	巡	遵	醇	処	初	所	暑	曙	渚	庶	緒	
	8F90	署	書	薯	藉	諸	助	叙	序	徐	恕	鋤	除	傷	償		
	8F9E		勝	匠	升	召	哨	商	嘗	獎	妾	媼	宵	將	小	少	
	8FAE	尚	庄	床	廠	影	承	抄	掌	捷	昇	昌	昭	晶	松	梢	
	8FBE	棟	樵	沼	消	涉	湘	燒	照	痘	省	硝	礎	祥	稱	章	
	8FCE	笑	粧	紹	尚	葛	蔣	蕪	裝	訟	証	詔	詳	象	賞	醫	
	8FDE	鉦	鍾	鐘	障	鞞	上	丈	乘	冗	剩	城	場	壤	壤	常	
	8FEE	情	擾	柔	杖	淨	狀	疊	蒸	讓	釀	錠	囑	墟	飾		
	903F		拭	植	殖	燭	織	職	触	食	蝕	辱	尻	伸	信	侵	

	Shift JIS	0	1	2	3	4	5	6	7	8	9	A	B	C	D	E	F
シ	904F	唇	娠	寝	審	心	慎	振	新	晋	森	榛	漫	深	申	疹	真
	905F	神	秦	紳	臣	芯	薪	親	診	身	辛	進	針	震	人	仁	刃
	906F	塵	壬	尋	甚	尽	腎	訊	迅	陣	韌						
ス	906F										箭	諏	須	酢	囟	厨	
	9080	逗	吹	垂	帥	推	水	炊	腫	粹	翠	衰	遂	醉	錐	鍾	随
	9090	瑞	翹	崇	嵩	数	枢	趨	難	据	杉	摺	菅	頤	雀	裾	
	909E																
セ	909E					世	瀬	欵	是	凄	制	勢	姓	征	性	成	政
	90AE	整	星	晴	棲	栖	正	清	牲	生	盛	精	聖	声	製	西	誠
	90BE	誓	請	逝	醒	青	静	齐	稅	脆	隻	席	惜	戚	斥	昔	析
	90CE	石	積	籍	績	青	責	赤	跡	蹟	碩	切	拙	接	撰	折	設
	90DE	窃	節	説	雪	絶	舌	蟬	仙	先	干	占	宣	專	尖	川	戰
	90EE	扇	撰	栓	栴	泉	浅	洗	染	潜	煎	爛	旋	穿	箭	線	
	913F		繼	羨	諫	舛	船	薦	詮	賤	踐	選	遷	錢	銑	閃	鮮
	914F	前	善	漸	然	全	禪	繕	繕	櫃							
ソ	914F									增	盟	岨	措	曾	曾	楚	
	915F	狙	疏	疎	礎	祖	租	粗	素	組	蘇	訴	阻	溯	鼠	僧	創
	916F	双	叢	倉	喪	壯	奏	爽	宋	層	匝	惣	惣	搜	掃	掃	掻
	9180	操	早	曹	巢	植	槽	漕	燥	争	復	相	窓	糟	総	綜	聡
	9190	草	莊	葬	蒼	藻	装	走	送	遭	鎗	霜	騒	像	増	憎	
	919E		臟	蔵	贈	造	促	側	則	即	息	捉	束	測	足	速	俗
	91AE	属	賊	族	統	卒	袖	其	揃	存	孫	尊	損	村	遜		
タ	91AE															他	多
	91BE	太	汰	説	唾	墮	妥	情	打	柁	舵	楢	陀	駄	驛	体	堆
	91CE	対	耐	岱	帯	待	怠	態	戴	替	泰	滯	胎	腿	苔	袋	貸
	91DE	退	逮	隊	黛	觸	代	台	大	第	醍	題	鷹	滝	灘	卓	啄
	91EE	宅	托	挾	拓	沢	濯	琢	託	鐸	濁	諾	茸	夙	蛸	只	
	923F		叩	但	達	辰	奪	脱	異	豎	迪	棚	谷	狸	鱧	禪	誰
	924F	丹	單	嘆	坦	担	探	旦	歎	淡	瀟	炭	短	端	葦	綻	耽
925F	胆	蛋	誕	鍛	団	壇	彈	断	暖	檀	段	男	談				
チ	925F													値	知	地	
	926F	弛	恥	智	池	痴	稚	置	致	蜘	遲	馳	築	畜	竹	筑	蓄
	9280	逐	秩	窒	茶	嫡	着	中	仲	宙	忠	抽	昼	柱	注	虫	衷
	9290	註	耐	鑄	駐	構	瀟	猪	苧	著	貯	丁	兆	淵	喋	寵	

	Shift JIS	0	1	2	3	4	5	6	7	8	9	A	B	C	D	E	F	
子	929E		粘	帳	疔	吊	張	彫	微	懲	挑	幅	朝	潮	練	町	眺	
	92AE		聽	脹	腸	蝶	調	謀	超	跳	姚	長	頂	鳥	勅	抄	直	朕
	92BE		沈	珍	賈	鎮	陳											
ツ	92BE						津	壁	椎	楯	追	錮	痛	通	塚	樽	捆	
	92CE		槻	佃	漬	柘	辻	蕨	綴	鏝	椿	漬	坪	壺	燻	軸	爪	吊
	92DE		約	鶴														
テ	92DE			亭	低	停	偵	刺	貞	呈	堤	定	帝	底	庭	廷	弟	
	92EE		悌	抵	挺	提	梯	汀	碇	禎	程	締	艇	訂	諦	蹄	遁	
	933F			邸	鄭	釘	鼎	泥	擢	擢	敵	滴	的	笛	適	鎗	溺	哲
	934F		徽	撤	轍	迭	鉄	典	填	天	展	店	添	纏	甜	貼	転	顛
	935F		点	伝	殿	殿	田	電										
ト	935F							兎	吐	堵	塗	妬	屠	徒	斗	杜	渡	
	936F		登	莖	賭	途	都	錠	砥	砥	努	度	土	奴	怒	倒	党	冬
	9380		凍	刀	唐	塔	塘	套	宕	島	嶋	悼	投	搭	東	桃	構	棟
	9390		盜	淘	湯	湯	灯	燈	当	痘	禱	等	答	筒	糖	統	到	
	939E			董	蕩	蕩	討	騰	豆	踏	逃	透	鐙	陶	頭	騰	關	働
	93AE		動	同	堂	導	懂	撞	洞	睡	童	胴	葡	道	銅	峠	鎗	匱
	93BE		得	德	洩	特	督	禿	篤	毒	独	読	拆	椽	凸	突	椽	届
	93CE		嵩	苔	夷	西	游	噸	屯	惇	敦	沌	豚	遁	頓	吞	曼	鈍
ナ	93DE		奈	那	内	乍	凧	薙	謎	灘	捺	綱	槽	馴	絹	暇	南	楠
	93EE		軟	難	汝													
ニ	93EE				二	尼	弑	迹	匂	賑	肉	虹	廿	日	乳	入		
	943F			如	尿	並	任	妊	忍	認								
又	943F									濡								
ネ	943F									襦	袴	寧		葱	猫	熱	年	
	944F		念	捻	燃	粘												
ノ	944F						乃	晒	之	竺	囊	惱	濃	納	能	腦	臙	
	945F		農	覗	蚤													
ハ	945F				巴	把	播	霸	杷	波	派	琶	破	婆	罵	芭	馬	
	946F		俳	庖	拝	排	敗	杯	盃	牌	背	肺	鞞	配	倍	培	媒	梅
	9480		楪	煤	狽	買	売	賠	陪	暹	蠅	秤	矧	菽	伯	剥	博	拍
	9490		柏	泊	白	箔	粕	舶	薄	迫	曝	漠	爆	縛	莫	駁	麥	
	949E			函	箱	谿	箸	肇	筈	榿	幅	肌	畑	島	八	鉢	澆	免
	94AE		醜	髮	伐	罰	抜	筏	闊	鳩	嘶	塙	蛤	隼	伴	判	半	反

	Shift JIS	0	1	2	3	4	5	6	7	8	9	A	B	C	D	E	F	
ハ	94BE 94CE	叛 采	帆 煩	搬 頒	斑 飯	板 挽	汜 晚	汎 番	版 盤	犯 警	班 蕃	畔 蠻	繁	般	藩	販	範	
ヒ	94CE 94DE 94EE 953F 954F 955F 956F	彼 詐 鼻 檢 廟 賣	悲 費 鼻 姬 描 頻	扉 避 終 媛 病 敏	批 非 神 紐 秒 瓶	披 飛 匹 百 苗	斐 桶 疋 謬 錯	比 販 髒 依 餒	泌 備 彥 彪 蒜	疲 尾 膝 標 蛭	皮 微 菱 水 鱒	碑 批 肘 漂 品	秘 毘 粥 瓢 彬	匪	卑	否	妃	庇
フ	956F 9580 9590 959E 95AE	斧 武 福 憤	普 舞 腹 扮	浮 葡 複 焚	父 蕪 覆 齏	不 符 部 覆 粉	付 腐 封 淵 糞	埠 膚 楓 弗 紛	夫 芙 風 弘 弄	婦 譜 葦 沸 文	富 負 露 仏 聞	富 賦 伏 物 聞	布 赴 副 劓	府 阜 復 分	怖 附 幅 吻	扶 侮 服 噴	敷 撫 墳	
ヘ	95AE 95BE 95CE	弊 備	柄 變	並 片	蔽 篇	閉 編	陛 辺	米 返	頁 遍	僻 便	壁 勉	癖 媿	併 碧 弁	丙	併	兵	嬭	幣
ホ	95CE 95DE 95EE 963F 964F 965F 966F	圃 俸	捕 包	步 果	甫 報	補 奉	輔 宝	穂 峰	募 峯	墓 崩	墓 庖	戊 抱	暮 捧	保 母	簿	蒼	鋪 做	
マ	9680 9690 969E	摩 鱗	磨 樹	魔 亦	麻 僕	埋 又	妹 抹	昧 末	枚 沫	每 迄	哩 侶	摸 蘭	幕 磨	膜 万	枕 慢	鯖 滿	証	
ミ	969E 96AE			味 眠	未 寐	魅 已	箕 箕	岬 密	密 蜜	湊 湊	羨 珍	脈 脈	妙					
ム	96AE			務	夢	無	牟	矛	霧	鷓	掠	婿	娘					
メ	96AE 96BE														冥	名	命	
モ	96BE 96CE															摸	模	
		茂	妄	孟	毛	猛	盲	網	耗	蒙	儲	木	默	目	李	勿	餅	

	Shift JIS	0	1	2	3	4	5	6	7	8	9	A	B	C	D	E	F
モ	96DE	尤	戾	羽	實	問	悶	紋	門	匆							
ヤ	96DE 96EE									也	冶	夜		爺	耶	野	弥
ユ	96EE 973F 974F												愉	愈	油	癒	
ヨ	974F 975F 976F 9780												有	幽	悠	憂	
ラ	9780 9790												揚	搖	擁	曜	
リ	9790 979E 97AE 97BE 97CE												利	史	履	李	
ル	97CE 97DE																
レ	97DE 97EE 983F																
ロ	983F 984F 985F																
ワ	985F 986F																

	Shift JIS	0 1 2 3	4 5 6 7	8 9 A B	C D E F
一	989E	弑 巧 丕			
丨	989E		个 非		
丿	989E		丿 并		
丩	989E			丩 义 乖 乘	
乙	989E				亂
丿	989E 98AE	舒			丿 豫 幸
二	98AE	式 于 亞	亟		
十	98AE		十 亢 京	毫 壹	
人	98AE 98BE 98CE 98DE 98EE 993F 994F	仞 伉 仵 价 佩 佰 倩 伴 俸 倚 佸 個 僎 假 會 信 尠 僎 傳 僎 僎 僎 僎	伉 佚 估 佛 來 俞 儘 倪 倪 倥 倥 倥 僎 僎 倥 倥 僎 僎 僎 僎	从 仍 佻 佻 佻 佻 俶 俶 俶 俶 倣 倣 倣 倣 僎 僎 僎 僎 僎 僎 僎 僎	仄 仆 仞 仗 修 侏 佻 佻 僎 俚 侗 佛 倣 倣 們 僎 僎 僎 僎 僎 僎 僎 僎 僎
儿	994F			儿 兀 兒	兌 免 兢 競
入	995F	兩 愈			
八	995F	兮 冀			
冂	995F		冂 回 册 冉	冂 冂 冂 冂	
冂	995F 996F	寫 幕			冂 冂 冂 冂
丷	996F	丷 决	冂 冲 冰 况	冂 冂 冂 冂	
几	996F 9980	風			几 處 凡 凭
凵	9980	凵 函			
刀	9980 9990 999E	刃 剝 剪 剝 剝 剝 剝 剝 辦	刊 剝 剝 剝 剝 剝 剝 剝	剝 剝 剝 剝 剝 剝 剝 剝	剝 剝 剝 剝 剝 剝 剝 剝
力	999E 99AE	劬 劬 勤	劬 劬 劬 劬	劬 劬 劬 劬	劬 劬 劬 劬
勹	99AE	勹 匆 旬	勹 勹 勹 勹		
匕	99AE			匕	
匚	99AE			匚 匚 匚	匚 匚

	Shift JIS	0	1	2	3	4	5	6	7	8	9	A	B	C	D	E	F		
匚	99AE																匚 區		
十	99BE	尗	卅	卅	卅	卂	卂												
卜	99BE								卞										
卩	99BE									卩	卩	卩	卩						
厂	99BE																厂 廛 廛 厦		
	99CE	廛	廛	廛															
厶	99CE				厶	厶	厶	厶	厶										
又	99CE									又	又	又	又						
口	99CE													叮	叨	叭	叭	吁	咄
	99DE	呀	听	吭	吼	吮	吮	吮	吞	呖	咏	呵	咎	呖	呱	呷	呷	咄	咄
	99EE	咒	呻	咀	嗽	咄	咄	咄	哇	号	威	啞	咬	哄	哈	咨			
	9A3F		咫	晒	咄	咄	咄	咄	哥	哦	睡	唔	哩	咄	哭	咄	咄	咄	咄
	9A4F	啖	啖	啖	啖	啖	啖	啖	啖	啖	啖	啖	啖	啖	啖	啖	啖	啖	啖
	9A4F	啖	啖	啖	啖	啖	啖	啖	啖	啖	啖	啖	啖	啖	啖	啖	啖	啖	啖
	9A5F	啖	啖	啖	啖	啖	啖	啖	啖	啖	啖	啖	啖	啖	啖	啖	啖	啖	啖
	9A6F	啖	啖	啖	啖	啖	啖	啖	啖	啖	啖	啖	啖	啖	啖	啖	啖	啖	啖
	9A80	啖	啖	啖	啖	啖	啖	啖	啖	啖	啖	啖	啖	啖	啖	啖	啖	啖	啖
	9A90	啖	啖	啖	啖	啖	啖	啖	啖	啖	啖	啖	啖	啖	啖	啖	啖	啖	啖
口	9A90									口	囧	囧	囧	囧	囧	囧	囧		
	9A9E	囧	囧	囧	囧	囧	囧	囧	囧	囧	囧	囧	囧	囧	囧	囧	囧		
土	9A9E									土	坏	址	坏	坏	坏	坏	坏		
	9AAE	坩	坩	坩	坩	坩	坩	坩	坩	坩	坩	坩	坩	坩	坩	坩	坩		
	9ABE	坩	坩	坩	坩	坩	坩	坩	坩	坩	坩	坩	坩	坩	坩	坩	坩		
	9ACE	坩	坩	坩	坩	坩	坩	坩	坩	坩	坩	坩	坩	坩	坩	坩	坩		
	9ADE	坩	坩	坩	坩	坩	坩	坩	坩	坩	坩	坩	坩	坩	坩	坩	坩		
士	9ADE				壯	壺	壺	壺	壺	壺									
夕	9ADE									夕									
文	9ADE										文	文	文						
夕	9ADE													夕	夕	夕			
大	9ADE																夫		
	9AEE	夫	夫	夫	夫	夫	夫	夫	夫	夫	夫	夫	夫	夫	夫	夫	夫		
女	9B3F		奸	妁	妁	倭	倭	妁	妁	媧	媧	媧	媧	媧	媧	媧	媧		
	9B4F	媧	媧	媧	媧	媧	媧	媧	媧	媧	媧	媧	媧	媧	媧	媧	媧		
	9B5F	媧	媧	媧	媧	媧	媧	媧	媧	媧	媧	媧	媧	媧	媧	媧	媧		
	9B6F	媧	媧	媧	媧	媧	媧	媧	媧	媧	媧	媧	媧	媧	媧	媧	媧		

	Shift JIS	0	1	2	3	4	5	6	7	8	9	A	B	C	D	E	F
子	9B6F				子	孕	孚	孛	孛	孩	執	孛	孛	學	孛	孛	
宀	9B6F																宀
	9B80	它	宀	宀	宀	宀	宀	宀	宀	宀	宀	宀	宀	宀	宀	宀	宀
	9B90	寶															寶
寸	9B90		尗	尗	尗	對											
小	9B90					尔	尗										
尗	9B90							尗	尗								
尸	9B90									尸	尹	屍		屍	屍	屍	
	9B9E		屍	屍	屍	屬											
尗	9B9E					尗											
山	9B9E						山	山	山	屹	岌	岑	岔	岌	岌	岌	岌
	9BAE	岌	岌	岌	岌	岌	岌	岌	岌	岌	岌	岌	岌	岌	岌	岌	岌
	9BBE	岌	岌	岌	岌	岌	岌	岌	岌	岌	岌	岌	岌	岌	岌	岌	岌
	9BCE	岌	岌	岌	岌	岌	岌	岌	岌	岌	岌	岌	岌	岌	岌	岌	岌
《《	9BCE																《《
工	9BDE	巫															
巳	9BDE		巳	巳													
巾	9BDE				巾	巾	巾	巾	巾	巾	巾	巾	巾	巾	巾	巾	巾
	9BEE	巾	巾	巾	巾												
干	9BEE				干	干											
幺	9BEE					幺	麼										
广	9BEE									广	庠	廂	廂	厦	厦	厦	
	9C3F		庠	庠	庠	庠	庠	庠	庠	庠	庠	庠	庠	庠	庠	庠	
廂	9C3F																廂
井	9C4F	井	井	井	井	井											
弋	9C4F					弋	弋										
弓	9C4F							弓	弓	弓	弓	弓	弓	弓	弓	弓	弓
彡	9C5F	彡	彡	彡	彡												
彡	9C5F					彡	彡										
彡	9C5F						彡	彡	彡	彡	彡	彡	彡	彡	彡	彡	彡
	9C6F	彡	彡	彡	彡	彡	彡										
心	9C6F					心	心	心	心	心	心	心	心	心	心	心	心
	9C80	心	心	心	心	心	心	心	心	心	心	心	心	心	心	心	心
	9C90	心	心	心	心	心	心	心	心	心	心	心	心	心	心	心	心

	Shift JIS	0	1	2	3	4	5	6	7	8	9	A	B	C	D	E	F
心	9C9E		忪	悛	悛	悛	悛	悛	悛	悛	悛	悛	悛	悛	悛	悛	悛
	9CAE		悛	悛	悛	悛	悛	悛	悛	悛	悛	悛	悛	悛	悛	悛	悛
	9CBE		悛	悛	悛	悛	悛	悛	悛	悛	悛	悛	悛	悛	悛	悛	悛
	9CCE		悛	悛	悛	悛	悛	悛	悛	悛	悛	悛	悛	悛	悛	悛	悛
	9CDE		悛	悛	悛	悛	悛	悛	悛	悛	悛	悛	悛	悛	悛	悛	悛
	9CEE		悛	悛	悛	悛	悛	悛	悛	悛	悛	悛	悛	悛	悛	悛	悛
戈	9CEE									戈	戍	戍		戍	戍	戍	
	9D3F		戍	戍	戍	戍	戍	戍	戍								
尸	9D3F									尸							
手	9D3F									扌	扌	扌	扌	扌	扌	扌	扌
	9D4F		扌	扌	扌	扌	扌	扌	扌	扌	扌	扌	扌	扌	扌	扌	扌
	9D5F		扌	扌	扌	扌	扌	扌	扌	扌	扌	扌	扌	扌	扌	扌	扌
	9D6F		扌	扌	扌	扌	扌	扌	扌	扌	扌	扌	扌	扌	扌	扌	扌
	9D80		扌	扌	扌	扌	扌	扌	扌	扌	扌	扌	扌	扌	扌	扌	扌
	9D90		扌	扌	扌	扌	扌	扌	扌	扌	扌	扌	扌	扌	扌	扌	扌
	9D9E		扌	扌	扌	扌	扌	扌	扌	扌	扌	扌	扌	扌	扌	扌	扌
	9DAE		扌	扌	扌	扌	扌	扌	扌	扌	扌	扌	扌	扌	扌	扌	扌
攴	9DAE													攴	攴	攴	
	9DBE		攴	攴	攴	攴	攴	攴	攴	攴	攴	攴	攴	攴	攴	攴	攴
斗	9DBE																斗
	9DCE		斗														
斤	9DCE		斤														
方	9DCE			方	方	方	方	方	方	方	方	方	方				
无	9DCE												无	无			
日	9DCE													日	日	日	
	9DDE		日	日	日	日	日	日	日	日	日	日	日	日	日	日	日
	9DEE		日	日	日	日	日	日	日	日	日	日	日	日	日	日	日
	9E3F		日	日	日	日	日	日	日	日	日	日	日	日	日	日	日
日	9E3F									日	日	日					
	9E4F		日	日	日	日	日	日	日					日	日	日	日
木	9E4F		木	木	木	木	木	木	木	木	木	木	木	木	木	木	木
	9E5F		木	木	木	木	木	木	木	木	木	木	木	木	木	木	木
	9E6F		木	木	木	木	木	木	木	木	木	木	木	木	木	木	木

	Shift JIS	0	1	2	3	4	5	6	7	8	9	A	B	C	D	E	F		
木	9E80	梳	栉	杵	档	桷	椴	梟	桔	梭	椴	條	椰	挺	檣	柝	桴		
	9E90	梵	栢	栳	栲	栳	栳	栳	栳	栳	栳	栳	栳	栳	栳	栳	栳	栳	
	9E9E		栳	栳	栳	栳	栳	栳	栳	栳	栳	栳	栳	栳	栳	栳	栳	栳	
	9EAE	栳	栳	栳	栳	栳	栳	栳	栳	栳	栳	栳	栳	栳	栳	栳	栳	栳	
	9EBE	栳	栳	栳	栳	栳	栳	栳	栳	栳	栳	栳	栳	栳	栳	栳	栳	栳	
	9ECE	栳	栳	栳	栳	栳	栳	栳	栳	栳	栳	栳	栳	栳	栳	栳	栳	栳	栳
	9EDE	栳	栳	栳	栳	栳	栳	栳	栳	栳	栳	栳	栳	栳	栳	栳	栳	栳	栳
	9EEE	栳	栳	栳	栳	栳	栳	栳	栳	栳	栳	栳	栳	栳	栳	栳	栳	栳	栳
	9F3F		栳	栳	栳	栳	栳	栳	栳	栳	栳	栳	栳	栳	栳	栳	栳	栳	栳
	9F4F		栳	栳	栳	栳	栳	栳	栳	栳	栳	栳	栳	栳	栳	栳	栳	栳	栳
欠	9F4F								欸	欸	盜	欸	欸	歌	歌	歌	歌		
	9F5F	欸	欸	欸	欸	欸													
止	9F5F					歸													
歹	9F5F							歹	歹	歹	歹	歹	歹	歹	歹	歹	歹		
	9F6F	歹	歹	歹	歹	歹													
夂	9F6F					夂	夂	夂	夂	夂									
母	9F6F									母	母								
毛	9F6F										毛			毛	毛	毛	毛		
	9F80	毛	毛																
氏	9F80			氏															
气	9F80			气		气	气	气											
水	9F80							水	水	水	水	水	水	水	水	水	水		
	9F90	水	水	水	水	水	水	水	水	水	水	水	水	水	水	水	水	水	
	9F9E		水	水	水	水	水	水	水	水	水	水	水	水	水	水	水	水	
	9FAE	水	水	水	水	水	水	水	水	水	水	水	水	水	水	水	水	水	
	9FBE	水	水	水	水	水	水	水	水	水	水	水	水	水	水	水	水	水	
	9FCE	水	水	水	水	水	水	水	水	水	水	水	水	水	水	水	水	水	
	9FDE	水	水	水	水	水	水	水	水	水	水	水	水	水	水	水	水	水	
	9FEE	水	水	水	水	水	水	水	水	水	水	水	水	水	水	水	水	水	
	E03F		水	水	水	水	水	水	水	水	水	水	水	水	水	水	水	水	
	E04F	水	水	水	水	水	水	水	水	水	水	水	水	水	水	水	水	水	
E05F	水	水	水	水	水	水	水	水	水	水	水	水	水	水	水	水	水		
E06F	水	水	水	水	水	水	水	水	水	水	水	水	水	水	水	水	水		
火	E06F					火	火	火	火	火	火	火	火	火	火	火	火		

	Shift JIS	0	1	2	3	4	5	6	7	8	9	A	B	C	D	E	F
火	E080	烙	焉	烽	焜	焙	煥	熙	熙	煎	榮	煌	煖	煬	煨	煨	煨
	E090	熨	熨	熬	熨	熨	熨	熨	熨	燻	燎	燠	燠	燠	燠	燠	燠
	E09E		熨	熨	熨	熨	熨	熨									
爪	E09E								爭	爬	爰	爲					
爻	E09E												爻	爻	爻	爻	爻
片	E09E														片	片	片
	EOAE	腭	腭														
牛	EOAE		牴	牴		犂	犂	犂	犂	犂	犂	犂	犂				
犬	EOAE													犹	豺	狙	狎
	EOBE	狎	狎	狎	狎	狎	狎	狎	狎	狎	狎	狎	狎	狎	狎	狎	狎
	EOCE	狎	狎	狎	狎	狎	狎	狎	狎	狎	狎	狎	狎	狎	狎	狎	狎
王	EOCE														珈	玳	玳
	EODE	玻	珀	珥	珥	珥	珥	珥	珥	珥	珥	珥	珥	珥	玳	玳	玳
	EOEE	璠	璠	璠	璠	璠	璠	璠	璠	璠	璠	璠	璠	璠	璠	璠	璠
瓜	E13F		瓠	瓠													
瓦	E13F				𠄎	𠄎	𠄎	𠄎	𠄎	𠄎	𠄎	𠄎	𠄎	𠄎	𠄎	𠄎	𠄎
	E14F	𠄎	𠄎	𠄎													
甘	E14F				𠄎												
生	E14F				𠄎												
用	E14F				𠄎												
田	E14F					𠄎	𠄎	𠄎	𠄎	𠄎	𠄎	𠄎	𠄎	𠄎	𠄎	𠄎	𠄎
	E15F	𠄎	𠄎	𠄎	𠄎	𠄎	𠄎	𠄎	𠄎	𠄎	𠄎	𠄎	𠄎	𠄎	𠄎	𠄎	𠄎
疒	E15F													疒	疒	疒	疒
	E16F	疒	疒	疒	疒	疒	疒	疒	疒	疒	疒	疒	疒	疒	疒	疒	疒
	E180	疒	疒	疒	疒	疒	疒	疒	疒	疒	疒	疒	疒	疒	疒	疒	疒
	E190	疒	疒	疒	疒	疒	疒	疒	疒	疒	疒	疒	疒	疒	疒	疒	疒
	E19E	疒	疒	疒	疒	疒	疒	疒	疒	疒	疒	疒	疒	疒	疒	疒	疒
𠄎	E19E		𠄎	𠄎	𠄎												
白	E19E					𠄎	𠄎	𠄎	𠄎	𠄎	𠄎	𠄎	𠄎	𠄎	𠄎	𠄎	𠄎
皮	E19E															𠄎	𠄎
	E1AE	𠄎	𠄎	𠄎													
血	E1AE			𠄎	𠄎	𠄎	𠄎	𠄎	𠄎	𠄎	𠄎	𠄎	𠄎	𠄎	𠄎	𠄎	𠄎
目	E1AE														𠄎	𠄎	𠄎
	E1BE	𠄎	𠄎	𠄎	𠄎	𠄎	𠄎	𠄎	𠄎	𠄎	𠄎	𠄎	𠄎	𠄎	𠄎	𠄎	𠄎

	Shift JIS	0	1	2	3	4	5	6	7	8	9	A	B	C	D	E	F
目	E10E E1DE	舉	睛	睛	睛	睜	睜	瞞	瞞	噴	暖	瞿	瞿	瞿	瞿	瞿	瞿
矛	E1DE		矜														
矢	E1DE			矣		矮											
石	E1DE E1EE E23F		磳	磳	磳	磳	磳	磳	磳	磳	磳	磳	磳	碎	磳	磳	磳
示	E23F E24F		祕	祕	祕	祕	祕	祕	祕	禪	禪	禪	禪	祀	詞	祗	崇
禺	E24F													禺	禺		
禾	E24F E25F E26F		秬	秬	秬	秬	秬	秬	秬	粟	粟	稱	稻		粟	稷	稷
穴	E26F E280		窟	窟	窟	窟	窟	窟	窟	窈	窗	窈	窈	窈	窈	窈	窈
立	E280 E290		竦	竦	竦				竦	奸	紛	氈	站	佇	竝	竝	竝
竹	E290 E29E E2AE E2BE E2CE E2DE		筵	筵	筵	筵	筵	筵	筵	筵	筵	筵	筵	筵	筵	筵	筵
米	E2DE E2EE		糝	糝	糝	糝	糝	糝	糝	糝	糝	糝	糝	糝	糝	糝	糝
糸	E2EE E33F E34F E35F E36F E380 E390		紉	紉	紉	紉	紉	紉	紉	紉	紉	紉	紉	紉	紉	紉	紉
缶	E390 E39E		罇	罇	罇	罇	罇	罇	罇					缸	缸		

	Shift JIS	0	1	2	3	4	5	6	7	8	9	A	B	C	D	E	F
网	E39E E3AE								网 罕	罔 采 罾 罟				電 罽 罾 罿			
羊	E3AE E3BE								羌 羔 羴	羴 玲 羴 羯				羴 羴 羴 羴			
羽	E3BE				翅 翠				翊 翕 翔 翯	翦 翮 翳 翹				翹			
老	E3BE															耆 耄 耋	
耒	E3CE								耒 耘 耜 耜	耨 耨							
耳	E3CE E3DE								耿 聃	聃 聆 聃 聃				聚 聃 聃 聃			
聿	E3DE								聿 聿	聿 聿							
肉	E3DE E3EE E43F E44F E45F													肱 肱 肱 脩	肚 肺 胃 肱		
臣	E45F													臧			
至	E45F													臺 臻			
臼	E45F E46F															臬 舂 舂	
舌	E46F				舍 舐				舐								
舟	E46F E480								舩 舫 舫	舫 舫 舫 舫				舫 舫 舫 舫			
艮	E480								艮								
色	E480								艷								
艸	E480 E490 E49E E4AE E4BE E4CE E4DE E4EE E53F E54F								艸	艾 芍 芒 莞	艾 芍 芒 莞	艾 芍 芒 莞	艾 芍 芒 莞	艾 芍 芒 莞	艾 芍 芒 莞	艾 芍 芒 莞	艾 芍 芒 莞
		苜 苜 苜 苜	苜 苜 苜 苜	苜 苜 苜 苜	苜 苜 苜 苜	苜 苜 苜 苜	苜 苜 苜 苜	苜 苜 苜 苜	苜 苜 苜 苜	苜 苜 苜 苜	苜 苜 苜 苜	苜 苜 苜 苜	苜 苜 苜 苜	苜 苜 苜 苜	苜 苜 苜 苜	苜 苜 苜 苜	苜 苜 苜 苜
		苜 苜 苜 苜	苜 苜 苜 苜	苜 苜 苜 苜	苜 苜 苜 苜	苜 苜 苜 苜	苜 苜 苜 苜	苜 苜 苜 苜	苜 苜 苜 苜	苜 苜 苜 苜	苜 苜 苜 苜	苜 苜 苜 苜	苜 苜 苜 苜	苜 苜 苜 苜	苜 苜 苜 苜	苜 苜 苜 苜	苜 苜 苜 苜
		苜 苜 苜 苜	苜 苜 苜 苜	苜 苜 苜 苜	苜 苜 苜 苜	苜 苜 苜 苜	苜 苜 苜 苜	苜 苜 苜 苜	苜 苜 苜 苜	苜 苜 苜 苜	苜 苜 苜 苜	苜 苜 苜 苜	苜 苜 苜 苜	苜 苜 苜 苜	苜 苜 苜 苜	苜 苜 苜 苜	苜 苜 苜 苜
		苜 苜 苜 苜	苜 苜 苜 苜	苜 苜 苜 苜	苜 苜 苜 苜	苜 苜 苜 苜	苜 苜 苜 苜	苜 苜 苜 苜	苜 苜 苜 苜	苜 苜 苜 苜	苜 苜 苜 苜	苜 苜 苜 苜	苜 苜 苜 苜	苜 苜 苜 苜	苜 苜 苜 苜	苜 苜 苜 苜	苜 苜 苜 苜
		苜 苜 苜 苜	苜 苜 苜 苜	苜 苜 苜 苜	苜 苜 苜 苜	苜 苜 苜 苜	苜 苜 苜 苜	苜 苜 苜 苜	苜 苜 苜 苜	苜 苜 苜 苜	苜 苜 苜 苜	苜 苜 苜 苜	苜 苜 苜 苜	苜 苜 苜 苜	苜 苜 苜 苜	苜 苜 苜 苜	苜 苜 苜 苜
		苜 苜 苜 苜	苜 苜 苜 苜	苜 苜 苜 苜	苜 苜 苜 苜	苜 苜 苜 苜	苜 苜 苜 苜	苜 苜 苜 苜	苜 苜 苜 苜	苜 苜 苜 苜	苜 苜 苜 苜	苜 苜 苜 苜	苜 苜 苜 苜	苜 苜 苜 苜	苜 苜 苜 苜	苜 苜 苜 苜	苜 苜 苜 苜
		苜 苜 苜 苜	苜 苜 苜 苜	苜 苜 苜 苜	苜 苜 苜 苜	苜 苜 苜 苜	苜 苜 苜 苜	苜 苜 苜 苜	苜 苜 苜 苜	苜 苜 苜 苜	苜 苜 苜 苜	苜 苜 苜 苜	苜 苜 苜 苜	苜 苜 苜 苜	苜 苜 苜 苜	苜 苜 苜 苜	苜 苜 苜 苜
		苜 苜 苜 苜	苜 苜 苜 苜	苜 苜 苜 苜	苜 苜 苜 苜	苜 苜 苜 苜	苜 苜 苜 苜	苜 苜 苜 苜	苜 苜 苜 苜	苜 苜 苜 苜	苜 苜 苜 苜	苜 苜 苜 苜	苜 苜 苜 苜	苜 苜 苜 苜	苜 苜 苜 苜	苜 苜 苜 苜	苜 苜 苜 苜
		苜 苜 苜 苜	苜 苜 苜 苜	苜 苜 苜 苜	苜 苜 苜 苜	苜 苜 苜 苜	苜 苜 苜 苜	苜 苜 苜 苜	苜 苜 苜 苜	苜 苜 苜 苜	苜 苜 苜 苜	苜 苜 苜 苜	苜 苜 苜 苜	苜 苜 苜 苜	苜 苜 苜 苜	苜 苜 苜 苜	苜 苜 苜 苜

	Shift JIS	0	1	2	3	4	5	6	7	8	9	A	B	C	D	E	F
艸	E55F	蘋	蘋	蘭	蘆	龍	蘇	蔞	蘿								
虍	E55F									虍	廌	虍	虍	虍	虍		
虫	E55F															虱	蚋
	E56F	蚩	蚪	蚋	蚌	蚶	蚯	蛄	蛆	蚰	蛉	蠊	蛇	蝮	蝮	蚤	蚤
	E580	蚊	蛛	蛇	蟻	蟻	蜈	蠍	蠍	蛻	蚤	蟬	蝻	蝻	蝻	蝻	蝻
	E590	蟻	蜻	蜥	蜈	蜚	蠊	蜈	蜈	蚶	蝻	蝻	蝻	蝻	蝻	蝻	蝻
	E59E		蝻	蝻	蝻	蝻	蝻	蝻	蝻	蝻	蝻	蝻	蝻	蝻	蝻	蝻	蝻
	E5AE	蝻	蝻	蝻	蝻	蝻	蝻	蝻	蝻	蝻	蝻	蝻	蝻	蝻	蝻	蝻	蝻
	E5BE	蝻	蝻	蝻	蝻	蝻	蝻	蝻	蝻	蝻	蝻	蝻	蝻	蝻	蝻	蝻	蝻
血	E5BE									衄	衄						
行	E5BE											衄	衄	衄	衄		
衣	E5BE																衫
	E5CE	衾	衾	袂	袂	袂	袂	袂	袂	袂	袂	袂	袂	袂	袂	袂	袂
	E5DE	袂	袂	袂	袂	袂	袂	袂	袂	袂	袂	袂	袂	袂	袂	袂	袂
	E5EE	袂	袂	袂	袂	袂	袂	袂	袂	袂	袂	袂	袂	袂	袂	袂	袂
	E63F		袂	袂	袂	袂	袂	袂	袂	袂	袂	袂	袂	袂	袂	袂	袂
西	E63F									西	覃	覈	覈				
見	E63F															覈	覈
	E64F	覈	覈	覈	覈	覈	覈	覈	覈	覈	覈	覈	覈	覈	覈	覈	覈
角	E64F									觚	觚	觚	觚	觚	觚		
言	E64F																訃
	E65F	訃	訃	訃	訃	訃	訃	訃	訃	訃	訃	訃	訃	訃	訃	訃	訃
	E66F	訃	訃	訃	訃	訃	訃	訃	訃	訃	訃	訃	訃	訃	訃	訃	訃
	E680	訃	訃	訃	訃	訃	訃	訃	訃	訃	訃	訃	訃	訃	訃	訃	訃
	E690	訃	訃	訃	訃	訃	訃	訃	訃	訃	訃	訃	訃	訃	訃	訃	訃
E69E		訃	訃	訃	訃	訃	訃	訃	訃	訃	訃	訃	訃	訃	訃	訃	
谷	E69E															谷	
E6AE	谷																
豆	E6AE		豈	豈	豈	豈											
豕	E6AE					豕	豕	豕									
豸	E6AE									豸	豸	豸	豸	豸	豸	豸	豸
	E6BE	豸	豸	豸													
貝	E6BE			賈	賈	賈	賈	賈	賈	貳	貳	貳	賈	賈	賈	賈	賈
	E6CE	賈	賈	賈	賈	賈	賈	賈	賈	賈	賈	賈	賈	賈	賈	賈	賈

	Shift JIS	0	1	2	3	4	5	6	7	8	9	A	B	C	D	E	F
赤	E6CE E6DE																赧
走	E6DE		走	趙	趙												
足	E6DE E6EE E73F E74F		跟	跣	跣	跣	跣	跣	跣	跣	跣	跣	跣	跣	跣	跣	跣
身	E74F E75F													躬	躬	躬	躬
車	E75F E76F E780		軋	軋	軋	軋	軋	軋	軋	軋	軋	軋	軋	軋	軋	軋	軋
辛	E780																
辵	E780 E790 E79E E7AE		逦	逦	逦	逦	逦	逦	逦	逦	逦	逦	逦	逦	逦	逦	逦
邑	E7AE E7BE									邨	邨	邨	邨	邨	邨	邨	邨
酉	E7BE E7CE									酏	酏	酏	酏	酏	酏	酏	酏
采	E7CE									糶	糶						
里	E7CE										量						
金	E7CE E7DE E7EE E83F E84F E85F E86F		釵	鉗	鉗	鉗	鉗	鉗	鉗	鉗	鉗	鉗	鉗	鉗	鉗	鉗	鉗
門	E86F E880 E890		闕	闕	闕	闕	闕	闕	闕	闕	闕	闕	闕	闕	闕	闕	闕
阜	E890					阡	阡	阡	阡	阡	阡	阡	阡	阡	阡	阡	阡

	Shift JIS	0 1 2 3	4 5 6 7	8 9 A B	C D E F
阜	E89E	陟 陟 陟	陟 陟 陟 陟	陟 陟 陟 陟	陟 陟 陟 陟
康	E8AE	康 康			
佳	E8AE	佳 佳	佳 佳 佳 佳	佳 佳 佳	
雨	E8AE			電	電 電 電 電
	E8BE	電 電 電 電	電 電 電 電	電 電 電 電	電 電 電 電
青	E8CE	靜			
非	E8CE	非			
面	E8CE	面 面	面		
革	E8CE		勒 鞞 鞞	鞞 鞞 鞞 鞞	鞞 鞞 鞞 鞞
	E8DE	鞞 鞞 鞞 鞞	鞞 鞞 鞞 鞞	鞞 鞞	
韋	E8DE			韋 韋	
韭	E8DE				韭 韭 韭
音	E8DE				竟
	E8EE	韶 鈞			
頁	E8EE	頤 頤	頤 頤 頤 頤	頤 頤 頤 頤	頤 頤 頤 頤
	E93F	頤 頤 頤			
風	E93F		風 風 風 風	風 風 風	
食	E93F			純	鈇 鈇 鈇 鈇
	E94F	餠 餠 餠 餠	餠 餠 餠 餠	餠 餠 餠 餠	餠 餠 餠 餠
	E95F	餠 餠 餠 餠			
首	E95F		首 首		
香	E95F		香		
馬	E95F		馭	馮 馮 馮 馮	駝 駝 駝 駝
	E96F	馮 馮 馮 馮	馮 馮 馮 馮	馮 馮 馮 馮	馮 馮 馮 馮
	E980	馮 馮 馮 馮	馮 馮 馮 馮	馮 馮 馮 馮	
骨	E980				肝 股 股 股
	E990	體 體 體 體			
高	E990		高		
髟	E990		髟 髟 髟	髟 髟 髟 髟	髟 髟 髟
	E99E	髟 髟 髟	髟 髟 髟 髟		
門	E99E			門 門 門 門	門 門
豐	E99E				豐
高	E99E				高
鬼	E9AE	魄 魃 魏 魃	魃 魃 魃		

	Shift JIS	0	1	2	3	4	5	6	7	8	9	A	B	C	D	E	F
魚	E9AE								魴	魷	鮪	鮑	鮑	鮪	鮫	鮫	鮪
	E9BE	鮪	鮪	鮪	鮪	鮪	鮪	鮪	鮪	鮪	鮪	鮪	鮪	鮪	鮪	鮪	鮪
	E9CE	鮪	鮪	鮪	鮪	鮪	鮪	鮪	鮪	鮪	鮪	鮪	鮪	鮪	鮪	鮪	鮪
	E9DE	鮪	鮪	鮪	鮪	鮪	鮪	鮪	鮪	鮪	鮪						
鳥	E9DE													鳩	鳩	鳩	
	E9EE	鳩	鳩	鳩	鳩	鳩	鳩	鳩	鳩	鳩	鳩	鳩	鳩	鳩	鳩	鳩	鳩
	EA3F		鳩	鳩	鳩	鳩	鳩	鳩	鳩	鳩	鳩	鳩	鳩	鳩	鳩	鳩	鳩
	EA4F	鳩	鳩	鳩	鳩	鳩	鳩	鳩	鳩	鳩	鳩	鳩	鳩	鳩	鳩	鳩	鳩
	EA5F	鳩	鳩	鳩													
齒	EA5F				齒	齒	齒										
鹿	EA5F							鹿	鹿	鹿	鹿	鹿	鹿	鹿	鹿	鹿	
妻	EA5F															妻	妻
	EA6F	妻	妻	妻													
麻	EA6F				麻												
黃	EA6F					黃											
黍	EA6F					黍	黍	黍									
黑	EA6F									黑	黑	黑	黑	黑	黑	黑	
	EA80	黑	黑	黑													
册	EA80				册	册	册										
龜	EA80						龜	龜	龜								
鼓	EA80									鼓	鼓						
鼠	EA80										鼠		鼠				
鼻	EA80													鼻			
齊	EA80														齊		
齒	EA80															齒	
	EA90	齒	齒	齒	齒	齒	齒	齒	齒	齒	齒	齒					
龍	EA90												龍				
龜	EA90													龜			
禽	EA90														禽		

[ESC+BV] MaxiCode (Compatible command)

Hexadecimal code	ESC	BV	Parameter
	<1B> ₁₆	<42> ₁₆ <56> ₁₆	a,b,c,ddddddddd,eee,fff,n...n
Initial value	Nil		

Valid range and term of command	When the power is OFF	The set parameter is not maintained.
	Valid range within items	The set parameter becomes invalid.
	Valid range between items	The set parameter becomes invalid.

[Function]

Specifying MaxiCode.

[Format]

<BV>a,b,c,ddddddddd,eee,fff,n...n

- Parameter
 - a [Symbol number] = Valid Range : 1 to 8
 - b [Number of symbol digit] = Valid Range : 1 to 8
 - c [Mode]
 - 2 : Transportation only
 - 3 : Transportation only
 - 4 : Standard symbol
 - 6 : Reader programing
 - d [Postal code] = Valid Range : 0 to 999999999 (Mode 2)
000000 to 999999 (Mode 3)
 - * Mode 2: Max 9 digits (Numeric only)
 - * Mode 3: Fixed 6 digits (Capital alphabet)
 - e [Country code] = Valid Range : 001 to 999
 - f [Service class] = Valid Range : 001 to 999
 - n [Low priority message] = Alphanumeric/Symbol

Mode	Service class	Country code	Postal code	Maximum print data	
				Numeric only	Alphanumeric
2	Fixed 3 digits (Numeric only)	Fixed 3 digits (Numeric only)	Max. 9 digits	123	84
3			Fixed 6 digits (Alphanumeric)		
4	Omission			138	93
6					

[Coding Example]

```
<A>
<V>100<H>200<BV>1,1,2,123456789,001,002,SAHTHA
<Q>2
<Z>
```

[Supplementary Explanation]

- Size of MaxiCode are not changed by number of data for printing.
- If parameter that is not described above is used, or number of print data does not match, symbol is not printed.
- When specifying mode 4 and mode 6, number of print data must be specified over 12. When number of print data is specified less than 11, scanner cannot read printed MaxiCode.

[Precautions during use]

- This is the command of MB2i series. Recommend the use of <2D20>.

MaxiCode Code table

					S				I				S				O			
				B8	0	0	0	0	0	0	0	0	1	1	1	1	1	1	1	1
				B7	0	0	0	0	1	1	1	1	0	0	0	0	1	1	1	1
				B6	0	0	1	1	0	0	1	1	0	0	1	1	0	0	1	1
				B5	0	1	0	1	0	1	0	1	0	1	0	1	0	1	0	1
B4	B3	B2	B1		0	1	2	3	4	5	6	7	8	9	A	B	C	D	E	F
0	0	0	0	0			SP	0	@	P	`	p								
0	0	0	1	1			!	1	A	Q	a	q								
0	0	1	0	2			~	2	B	R	b	r								
0	0	1	1	3			#	3	C	S	c	s								
0	1	0	0	4			\$	4	D	T	d	t								
0	1	0	1	5			%	5	E	U	e	u								
0	1	1	0	6			&	6	F	V	f	v								
0	1	1	1	7			'	7	G	W	g	w								
1	0	0	0	8			(8	H	X	h	x								
1	0	0	1	9)	9	I	Y	i	y								
1	0	1	0	A			*	:	J	Z	j	z								
1	0	1	1	B			+	;	K	[k	{								
1	1	0	0	C			,	<	L	¥	l									
1	1	0	1	D			-	=	M]	m	}								
1	1	1	0	E			.	>	N	^	n	~								
1	1	1	1	F			/	?	O	_	o	DEL								

MaxiCode can specify from 1H to FFH.

[ESC+BK] PDF417 (Compatible command)

Hexadecimal code	ESC	BK	Parameter
	<1B> ₁₆	<42> ₁₆ <4B> ₁₆	aabbcddeefffg...g(,h)
Initial value	Nil		
Valid range and term of command	When the power is OFF	The set parameter is not maintained.	
	Valid range within items	The set parameter becomes invalid.	
	Valid range between items	The set parameter becomes invalid.	

[Function]

Specifying PDF417.

[Format]

<BK>aabbcddeefffg...g(,h)

- Parameter
 - a [Minimum module width] = Valid range : 01 to 27 dots
 - b [Minimum module height] = Valid range : 01 to 72 dots
 - c [Security level] = Valid range : 0 to 8
 - d [No. of data code words per digit]
 - Valid range : 01 to 30
 - 00 : Automatic (Width varies depending on the No. of data specified)
 - e [Digit No. per symbol]
 - Valid range : 03 to 90
 - 00 : Automatic (Height varies depending on the No. of data specified)
 - f [Digit No. of data] = Valid data : 0001 to 2681
 - g [Print data] = Data
 - h [PDF code type]
 - When omitted : PDF417
 - T : Truncated scale
 - M : Micro PDF

[Coding Example]

Minimum module width: 03 dots, Minimum module height: 09 dots, Security level: 3, Number of data codewords per line: 03, Digit Number of line per symbol: 18

```
<A>
<V>100<H>200<BK>0309303180010PDF1234567
<Q>2
<Z>
```

[Supplementary Explanation]

- Minimum module width can be set to 01 and 02; however, this may not be read properly.
- 01, 02, and 03 are designable for Minimum module height however; it may cause a reading problem.
- When d=e=00, aspect ratio will be at 1:2 based on the number of print data.
- When specifying security level high, parameter d or e should have large number.
- Maximum number of digit of data is 2,681, but it varies depending on Minimum module size, Security level and type of print data.

- When parameter d and e does not match number of data, print may not be performed properly.
- When Micro PDF is specified by PDF type, number per symbol is specified by number of data codeword per line, and accordingly maximum number of data digit is specified. For details, refer to "Symbol size and number of data" below.
- When specifying Micro PDF by PDF code type, security level is disabled.

[Point]

- Sequential number is not available.
- Specifying print position by automatic line feed is not available.
- Print 00H to FFH is available.
- Format registration is available.
- Enlarging minimum module size improves print quality.
- Increasing security level improves read rate.
- Print height varies depending on the character such as numeric only, alphabet only or mixture of numeric and alphabets.

[Precautions during use]

- This is the command of MB2i series. Recommend the use of <2D10>.

* Symbol size of Micro PDF417 is following 34 types in the table below.

[Symbol size and number of data of MicroPDF417]

Symbol size		Maximum number of data		
Cols(c)	Rows(d)	Alphabet (A to Z)	Numeric	Binary mode
1	11	6	8	3
	14	12	17	7
	17	18	26	10
	20	22	32	13
	24	30	44	18
	28	38	55	22
2	8	14	20	8
	11	24	35	14
	14	36	52	21
	17	46	67	27
	20	56	82	33
	23	64	93	38
	26	72	105	43
3	6	10	14	6
	8	18	26	10
	10	26	38	15
	12	34	49	20
	15	46	67	27

Symbol size		Maximum number of data		
Cols(c)	Rows(d)	Alphabet (A to Z)	Numeric	Binary mode
	20	66	96	39
	26	90	132	54
	32	114	167	68
	38	138	202	82
	44	162	237	97
4	4	14	20	8
	6	22	32	13
	8	34	49	20
	10	46	67	27
	12	58	85	34
	15	76	111	45
	20	106	155	63
	26	142	208	85
	32	178	261	106
	38	214	313	128
44	250	366	150	

- Mix of Alphabet (Capital letter, small letter), Numeric and Control code varies depending on number of combined characters.

PDF417 Code table

				S	I	S	O														
				B8	0	0	0	0	0	0	0	0	1	1	1	1	1	1	1	1	1
				B7	0	0	0	0	1	1	1	1	0	0	0	0	1	1	1	1	1
				B6	0	0	1	1	0	0	1	1	0	0	1	1	0	0	1	1	1
				B5	0	1	0	1	0	1	0	1	0	1	0	1	0	1	0	1	1
B4	B3	B2	B1		0	1	2	3	4	5	6	7	8	9	A	B	C	D	E	F	
0	0	0	0	0			SP	0	@	P	`	p									
0	0	0	1	1			!	1	A	Q	a	q									
0	0	1	0	2			~	2	B	R	b	r									
0	0	1	1	3			#	3	C	S	c	s									
0	1	0	0	4			\$	4	D	T	d	t									
0	1	0	1	5			%	5	E	U	e	u									
0	1	1	0	6			&	6	F	V	f	v									
0	1	1	1	7			'	7	G	W	g	w									
1	0	0	0	8			(8	H	X	h	x									
1	0	0	1	9)	9	I	Y	i	y									
1	0	1	0	A			*	:	J	Z	j	z									
1	0	1	1	B			+	;	K	[k	{									
1	1	0	0	C			,	<	L	¥	l										
1	1	0	1	D			-	=	M]	m	}									
1	1	1	0	E			.	>	N	^	n	~									
1	1	1	1	F			/	?	O	_	o	DEL									

PDF417 can specify from 00H to FFH.

[ESC+BX] DataMatrix (ECC200) (Compatible command)

Hexadecimal code	ESC	BX	Parameter
	<1B> ₁₆	<42> ₁₆ <58> ₁₆	aabbccddeeffghh
Initial value	Nil		

Valid range and term of command	When the power is OFF	The set parameter is not maintained.
	Valid range within items	The set parameter becomes invalid.
	Valid range between items	The set parameter becomes invalid.

[Function]

Specifying DataMatrix (ECC200).

[Format] (Setup part)

<BX>aabbccddeeffghh

- Parameter
 - a [Format ID]
Valid Range : 01 (Fixed)
 - b [Error correction level]
Valid Range : 20 (Fixed)
 - c [Cell width]
Valid Range : 01 to 99 (dot per cell)
 - d [Cell pitch]
Valid Range : 01 to 99 (dot per cell)
 - e [Number of cells per line]
Valid Range : 010 to 144
000 : (Auto setup)
 - f [Number of cell lines]
Valid Range : 008 to 414
000 : (Auto setup)
 - g [Mirror image]
Valid Range : 0 (Fixed)
 - h [Size of guide cell]
Valid Range : 01 (Fixed)

[Supplementary Explanation]

- 01 and 02 are designable for [Cell width] and [Cell Pitch]; however, they may not be read properly. In this case, 00 will be an error.
- If 000 is specified for both [No. of cells per line] and [Number of cell lines], optimum matrix size is set automatically based on the Number of data.

[Precautions during use]

- This is the command of MB2i series. Recommend the use of <2D50>.

[ESC+DC] DataMatrix (ECC200) Data Specify (Compatible command)

Hexadecimal code	ESC	DC	Parameter
	<1B> ₁₆	<44> ₁₆ <43> ₁₆	n...n
Initial value	Nil		

Valid range and term of command	When the power is OFF	The set parameter is not maintained.
	Valid range within items	The set parameter becomes invalid.
	Valid range between items	The set parameter becomes invalid.

[Function]

Specifying data for DataMatrix (ECC200).

[Format] (Data specification part)

<DC>n...n

- Parameter

n [Print data] = Data

[Coding Example]

Cell width: 02, Cell pitch: 02, Number of cells per line: 000 (Auto setup), Number of cell lines: 000 (Auto setup), Print data: 1234567890

```
<A>
<V>100<H>200
<BX>01200202000000001
<DC>1234567890
<Q>2
<Z>
```

[Supplementary Explanation]

- DataMatrix (ECC200) can specify from 00H to FFH except for printer control code of 05H, 10H, 11H, 18H, 1BH. When specifying control code for data, use DataMatrix<2D50>.

	Data format	Number of data
Data format	Numeric	3116
	Alphanumeric	2335
	Binary (00H to FFH)	1556

* Value in above table shows the maximum number of data that can be specified as barcode data.

[Precautions during use]

- This is the command of MB2i series. Recommend the use of <2D50>.

[ESC+FX] DataMatrix (ECC200) Sequential Number (Compatible command)

Hexadecimal code	ESC	FX	Parameter
	<1B> ₁₆	<46> ₁₆ <58> ₁₆	aaabccdddeee
Initial value	Nil		

Valid range and term of command	When the power is OFF	The set parameter is not maintained.
	Valid range within items	The set parameter becomes invalid.
	Valid range between items	The set parameter becomes invalid.

[Function]

Specifying sequential number for DataMatrix.

[Format] (Sequential number part)

<FX>aaabccdddeee

- Parameter
 - a [Number of duplication to print]
Valid Range : 001 to 999
 - b [Flag of increase and decrease]
+ : Increment
- : Decrement
 - c [Number of increase and decrease]
Valid Range : 001 to 999
 - d [Specification of digit position]
Valid Range : 001 to 999
 - e [Number of digit]
Valid Range : 001 to 999

[Coding Example]

Number of duplication to print: 001, Flag of increase and decrease: +, Number of increase and decrease: 001, Digit position: 005, Number of digit: 003

```
<A>
<V>100<H>200
<FX>001+001005003
<BX>01100202000000001
<DC>00006000
<Q>2
<Z>
```

[Precautions during use]

- This is the command of MB2i series. Recommend the use of <2D50>.

GS1 DataMatrix (ECC200) Code table (<DC>)

				S				I				S				O					
				B8	0	0	0	0	0	0	0	0	0	1	1	1	1	1	1	1	1
				B7	0	0	0	0	1	1	1	1	0	0	0	0	1	1	1	1	1
				B6	0	0	1	1	0	0	1	1	0	0	1	1	0	0	1	1	1
				B5	0	1	0	1	0	1	0	1	0	1	0	1	0	1	0	1	0
B4	B3	B2	B1		0	1	2	3	4	5	6	7	8	9	A	B	C	D	E	F	
0	0	0	0	0			SP	0	@	P	`	p									
0	0	0	1	1			!	1	A	Q	a	q									
0	0	1	0	2			"	2	B	R	b	r									
0	0	1	1	3			#	3	C	S	c	s									
0	1	0	0	4			\$	4	D	T	d	t									
0	1	0	1	5			%	5	E	U	e	u									
0	1	1	0	6			&	6	F	V	f	v									
0	1	1	1	7			'	7	G	W	g	w									
1	0	0	0	8			(8	H	X	h	x									
1	0	0	1	9)	9	I	Y	i	y									
1	0	1	0	A			*	:	J	Z	j	z									
1	0	1	1	B			+	;	K	[k	[
1	1	0	0	C			,	<	L	¥	l										
1	1	0	1	D			-	=	M]	m]									
1	1	1	0	E			.	>	N	^	n	~									
1	1	1	1	F			/	?	O	_	o	DEL									

GS1 DataMatrix (ECC200) can specify from 00H to FFH except for printer control code of 05H, 10H, 11H, 18H, 1BH.

When specifying 7EH, specify [7EH, 7EH].

[ESC+QV] QR code version

Hexadecimal code	ESC	QV	Parameter
	<1B> ₁₆	<51> ₁₆ <56> ₁₆	aa
Initial value	aa=00		

Valid range and term of command	When the power is OFF	The set parameter is not maintained.
	Valid range within items	The set parameter is in effect until a new specification is made.
	Valid range between items	The set parameter becomes a default value in the next item <A>.

[Function]

Specifying any QR code version can print the code with fixed cell size.

When not specified, it becomes the auto setting.

[Format]

<QV>aa

- Parameter

a [Version number]

Valid range : 00 to 40

(Specifying this range does not become a parameter error.

An error may arise for some QR code types, while analyzing the image.)

Print valid MODE1 : 00 to 14 (00: Auto setting)

MODE2 : 00 to 40 (00: Auto setting)

MicroQR : 00 to 04 (M1 to M4) (00: Auto setting)

[Coding Example 1]

MODEL 1, Error correction: H, Cell size font: 05, Manual setting, Normal mode, Version 14

<A>

<V>100<H>100 <2D31>,H,05,0,0

<QV>14

<DN>0011,0123456789X

<Q>1

<Z>

[Coding Example 2]

MODEL 2, Error correction: H, Cell size font: 05, Manual setting, Normal mode, Version 35

<A>

<V>100<H>100 <2D30>,H,05,0,0

<QV>35

<DN>0011,0123456789X

<Q>1

<Z>

[Coding Example 3]

MicroQR, Error correction: L, Cell size font: 05, Manual setting, Version M3

<A>

<V>100<H>100 <2D32>,L,05,0

<QV>3

<DN>005,01234

<Q>1

<Z>

[Supplemental Explanation]

- MODEL 1: up to 14, MODEL 2 up to 40, MicroQR: up to 4
The valid parameter range is from 0 to 40 and it varies depending on the QR code type.
- For MicroQR, 1 to 4 correspond with M1 to M4.
- Specifying <QV> 0 becomes Auto (Default: Compatible with the existing code).
- Sending the data exceeding the data size of specified version will result in error and QR code will not be printed.
- Specify the <QV> command in between <2Dxx> and <DN>/<DS>.
- It does not affect other than QR code.
- When resulted in a parameter error, it will be handled in the same manner of no specification.

[About the version]

Refer to the specifications of QR code for details.

Refer to the QR code specification for details. Version 1: 21 x 21 cell, Version 2: 25 x 25 cell, ..., Version 40: 177 x 177 cell.

For MicroQR, M1 to M4 = 11 x 11 to 17 x 17 cell, smaller than MODEL 1/2.

Graphic Command

[ESC+G] Graphic Print

Hexadecimal code	ESC	G	Parameter
	<1B> ₁₆	<47> ₁₆	abbbcccn...n
Initial value	Nil		

Valid range and term of command	When the power is OFF	The set parameter is not maintained.
	Valid range within items	The set parameter becomes invalid.
	Valid range between items	The set parameter becomes invalid.

[Function]

Specifying the print of graphic.

[Format]

<G>abbbcccn...n

- Parameter
 - a [Data specification by HEX and BIN]
 - H : Hex data
Specify graphic data as 2 characters of ASCII 0-F which is equal to 8 dots, output it as hex code corresponding to ASCII.
 - B : Binary data
Specify graphic data as one byte of binary which is equal to 8 dots.
 - b [Specification of crosswise graphic area per byte] = Valid range: Refer to the table below.
 - c [Specification of lengthwise graphic area per byte] = Valid range: Refer to the table below.
 - n [Graphic data]

[Coding Example 1]

[H: HEX data] is specified for [Data specification by HEX and BIN]

[□] is printed with the below specification.

```
<A>
<V>50<H>50
<G>H001001<4646383138313831383138314646>16
<Q>1
<Z>
```

[Coding Example 2]

[B: Binary data] is specified as [Data specification by HEX and BIN]

[□] is printed with the below specification.

```
<A>
<V>50<H>50
<G>B001001<FF8181818181FF>16
<Q>1
```

<Z>

[Supplementary Explanation]

- Specification of [B] has shorter program description than that of specification [H]; and, transfer data length is 50 percent shorter. This could be advantage in data capacity.
- Specification of Rotation <%> and Enlargement <L> are available.
- <L> command should be placed just before <G> command.
- When using rotation <%> and enlargement <L> commands at the same time, specify <%> command before <L>.
- The crosswise maximum byte and lengthwise maximum byte are specified in the table below, however, it is possible to specify up to 999 bytes to have compatibility with MB2i series.
The graphic data less than 2,937,600 bytes can be printed.
- The calculation of graphic data size is [crosswise maximum byte x lengthwise maximum byte x 8].

[Initial value of parameter and Valid Range]

Head density	Crosswise max. bytes	Lengthwise max. bytes
203 dpi	55	400

[ESC+GM] BMP File Print

Hexadecimal code	ESC	GM	Parameter
	<1B> ₁₆	<47> ₁₆ <4D> ₁₆	aaaaa,n...n
Initial value	Nil		

Valid range and term of command	When the power is OFF	The set parameter is not maintained.
	Valid range within items	The set parameter becomes invalid.
	Valid range between items	The set parameter becomes invalid.

[Function]

Specifying the print of BMP file created by such as Image editing application.

[Format]

<GM>aaaaa,n...n

- Parameter

a [Total bytes of BMP file]

n [Data]

[Coding Example]

<A>

<V>50<H>50<GM>04500,<424D00...00>₁₆

<Q>2

<Z>

[Supplementary Explanation]

- Data is sent in binary data (Outputs 8-dot, one byte in binary all at once) (BMP file size = Total byte size, BMP file data = data).
- When [Total bytes of BMP file] is not matching the transfer data, this may become the cause of malfunction.
- Total bytes are the file size displayed at [Property] and such.
- BMP file is available in Black/White mode only. In color mode, printing is not guaranteed. Also, this command is not valid for BMP compressed file.
Make sure that the file extension is set to [BMP] before printing.
- Rotation <%> and Enlargement <L> are available.
- Enlargement <L> should be placed just before this command.
- When using rotation <%> and enlargement <L> commands at the same time, specify <%> command before <L>.

[ESC+GP] PCX File Print

Hexadecimal code	ESC	GP	Parameter
	<1B> ₁₆	<47> ₁₆ <50> ₁₆	aaaaa,n...n
Initial value	Nil		

Valid range and term of command	When the power is OFF	The set parameter is maintained.
	Valid range within items	The set parameter becomes invalid.
	Valid range between items	The set parameter becomes invalid.

[Function]

Specifying the print of PCX file created by such as Image editing application.

[Format]

<GP>aaaaa,n...n

- Parameter
 - a [Total bytes of PCX file]
 - n [Data]

[Coding Example]

```
<A>
<V>50<H>50<GP>04500,XXXXXXXXXXXXX
<Q>2
<Z>
```

[Supplementary Explanation]

- Data is sent in binary data (Outputs 8-dot, one byte in binary all at once) (PCX file size = Total byte size, PCX file data = data).
- If [Total bytes of PCX file] is not matching the transfer data, this may become the cause of malfunction.
- Total bytes are the file size displayed at [Property] and such.
- PCX file is available in Black/White mode only. In color mode, printing will not be performed due to command error. Also, this command is not valid for PCX compressed file.
Make sure that the file extension is set to [PCX] before printing.
- Rotation <%> and Enlargement <L> are available.
- Enlargement <L> should be placed just before this command.
- When using rotation <%> and enlargement <L> commands at the same time, specify <%> command before <L>.

System Command

[ESC+CS] Print Speed

Hexadecimal code	ESC	CS	Parameter
	<1B> ₁₆	<43> ₁₆ <53> ₁₆	aa
Initial value	Refer to the table below.		
Valid range and term of command	When the power is OFF	The set parameter is maintained.	
	Valid range within items	The set parameter is valid until the next valid setting.	
	Valid range between items	The set parameter is valid until the next valid setting.	

[Function]

Specifying the speed of printing.

[Format]

<CS>aa

- Parameter

a [Print speed] = Refer to the table below.

[Coding Example]

<A>
<CS>4
<Z>

[Supplementary Explanation]

- Print speed value specified by the command or LCD is maintained.
- When operation mode is linerless cutter, the maximum speed will be 4 inches/sec, and initial value will be 4 inches/seconds. No command error will occur when 5 inches/seconds and the maximum value of each model is specified. In this case, no value will be set.

[Notes]

- If the value over valid range is specified, command error will occur and print speed will not be changed.
- Use default set operation of the printer to set back the value to the initial one.

[Parameter Initial Value and Specified Range]

Head density	Initial value [aa]	Parameter Valid Range	Print speed corresponding to parameter
203 dpi	4	3,4,5,6	3: 3 (inch/s) 76.2 (mm/s) 4: 4 (inch/s) 101.6 (mm/s) 5: 5 (inch/s) 127.0 (mm/s) 6: 6 (inch/s) 152.4 (mm/s)

[ESC+#F] Print Darkness

Hexadecimal code	ESC	#F	Parameter
	<1B> ₁₆	<23> ₁₆ <46> ₁₆	ab or aab
Initial value	Refer to the table below.		

Valid range and term of command	When the power is OFF	The set parameter is maintained.
	Valid range within items	The set parameter is valid until the next valid setting.
	Valid range between items	The set parameter is valid until the next valid setting.

[Function]

Specifies print darkness.

[Format]

<#F>ab

<#F>aab

- Parameter

a [Print darkness level specification]

1 ↑ Lightest

2

3

4

5

6

7

8

9

10 ↓ Darkest

b [Print darkness specification]

A to F (omissible)

This parameter is usually "A".

The parameter valid range differs depending on the model. (Refer to the table below)

[Coding Example]

<A>

<#F>5A

<Z>

[Supplementary Explanation]

- Print darkness value specified by the command or LCD is maintained.

[Notes]

- If the value over valid range is specified, command error will occur and print darkness will not be changed.
- Initial value is settable by default setting operation of the printer.

[Print darkness level range]

Initial value	Parameter valid range	When setting outside of valid range
5	1, 2, 3, 4, 5, 6, 7, 8, 9, 10	Command error will occur when other values than parameter valid range in the left is specified.

[Print darkness range]

Initial value	Parameter valid range	When setting outside of valid range
A	A	From B to F are reserved. The same darkness as A. Print darkness other than from A to F will be replaced with A. (It will not be a command error.)

[ESC+#E] Print Darkness (MB2i series compatible command)

Hexadecimal code	ESC	#E	Parameter
	<1B> ₁₆	<23> ₁₆ <45> ₁₆	ab
Initial value	Nil		

Valid range and term of command	When the power is OFF	The set parameter is maintained.
	Valid range within items	The set parameter is valid until the next valid setting.
	Valid range between items	The set parameter is valid until the next valid setting.

[Function]

Specifies print darkness.

[Format]

<#E>ab

- Parameter
 - a [Print darkness level specification]
 - 1 ↑ Lightest
 - 2
 - 3
 - 4
 - 5 ↓ Darkest
 - b [Print darkness specification]
 - A to F (omissible)
 - This parameter is usually "A".
 - The parameter valid range differs depending on the model. (Refer to the table below)

[Coding Example]

```
<A>
<#E>3A
<Z>
```

[Supplementary Explanation]

- Print darkness value specified by the command.

[Notes]

- This command is for the compatibility with MB2i series. The print darkness level obtained by DC2+PB, and the print darkness level on the display screen becomes twice the value set by this command.

[Print darkness level range]

Head density	Parameter valid range	When setting outside of valid range
203 dpi	1,2,3,4,5	Command error will occur when other values than parameter valid range in the left is specified.

[Print darkness range]

Parameter valid range	When setting outside of valid range
A	From B to F are reserved. The same darkness as A. Print darkness other than from A to F will be replaced with A. (It will not be a command error.)

[ESC+A1] Media Size

Hexadecimal code	ESC	A1	Parameter
	<1B> ₁₆	<41> ₁₆ <31> ₁₆	aaaabbbb VaaaaHbbbb
Initial value	Nil		

Valid range and term of command	When the power is OFF	The set parameter is not maintained.
	Valid range within items	The set parameter is valid until the next valid setting.
	Valid range between items	The set parameter is valid until the next valid setting.

[Function]

Specifying media size.

[Format]

<A1>aaaabbbb (A, B fixed) *Label size is less than 9999.

<A1>VaaaaHbbbb (A, B variable)

- Parameter

a [Height of label] = Valid range: Refer to the table below.

b [Width of label] = Valid range: Refer to the table below.

[Valid Range]

Head density	Width of label (dots)	Height of label (dots)
203 dpi	1 to 440	1 to 8000

[Coding example 1]

Label length: 800 dots, label width: 640 dots

<A>

<A1>08000640

<Z>

[Coding example 2]

Label length: 800 dots, label width: 640 dots

<A>

<A1>V800H640

<Z>

[Coding example 3]

Label length: 1200 dots, label width: 40 dots

<A>

<A1>12000040

<Z>

[Coding example 4]

Label length: 1200 dots, label width: 40 dots

<A>
<A1>V1200H40
<Z>

[Coding example 5]

Label length: 11200 dots, label width: 240 dots

<A>
<A1>V11200H240
<Z>

[Supplementary Explanation]

- If using the label smaller than the head width, use this command for specifying the label size and adjust the start point position corresponding to the label size.
- For specifying the label size, include the size of backing paper.

(Side alignment)

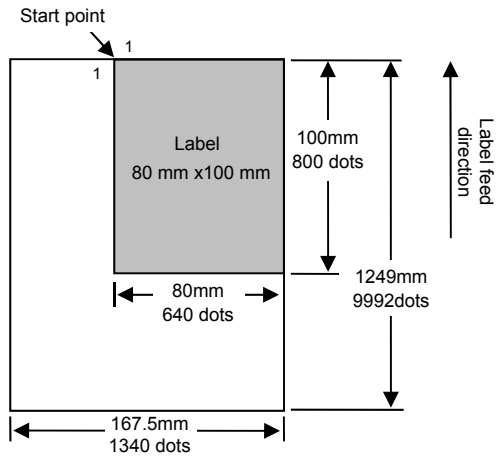

(Center alignment)

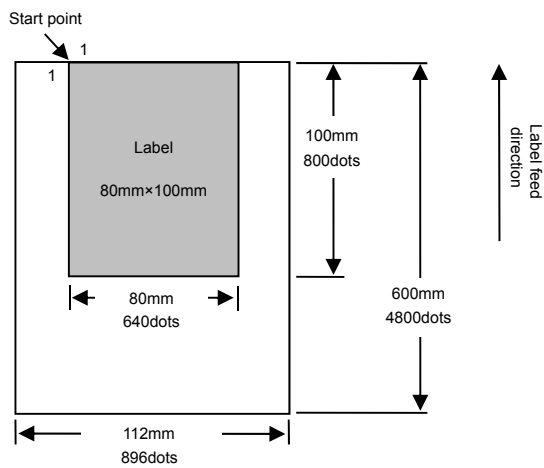

[ESC+A3] Base Reference Point

Hexadecimal code	ESC	A3	Parameter
	<1B> ₁₆	<41> ₁₆ <33> ₁₆	VabbbbHcdddd
Initial value	a=+,b=00000,c=+,d=0000		

Valid range and term of command	When the power is OFF	The set parameter is not maintained. (with the start point correction)
		The set parameter is maintained. (without the start point correction)
	Valid range within items	The set parameter is valid until the next valid setting.
	Valid range between items	The set parameter is valid until the next valid setting.

[Function]

Changing the start point coordinate in User mode of the printer (normally).

[Format]

<A3>VabbbbHcdddd

- Parameter
 - a [Vertical start point correction sign] = +, -
 - b [Vertical start point correction (No. of dots)] = Refer to the table below
 - c [Horizontal start point correction sign] = +, -
 - d [Horizontal start point correction (No. of dots)] = Refer to the table below

[Coding Example]

```
<A>
<A3>V+10H+10
<Z>
```

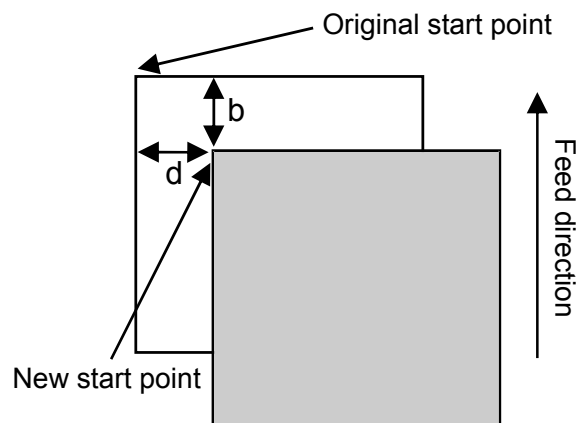

[Supplementary Explanation]

- If changing start point correction and being located outside of printing area, printing may not be performed.
- When changing start point correction through multiple label formats, correction will affect all of the formats.

NOTE:

- This command is effective prior to the User mode settings of printer LCD.
- The offset value specified by the start point correction <A3> with the start point correction sign is not saved. Thus, the offset value specified by the <A3> command is maintained until the change is made by the next <A3> or the power is off (See [Valid range and saving parameter]).
- The offset value specified by the <A3> command without the sign (+/-) is registered also in the user mode of the printer LCD. Thus, the offset value specified by the <A3> command is maintained even the power is off. However this is a format to be compatible with MB2i series. Please specify the sign (+/-) in normal operation (See [Valid range and saving parameter]).

[Valid range and saving parameter]

Head density	Horizontal start point correction (dots)	Vertical start point correction (dots)
203 dpi	0 to 300	0 to 300

Head density	Horizontal start point correction (dots)	Vertical start point correction (dots)	Saving parameter
203 dpi	-300 to +300	-300 to +300	With (+/-) sign: Not saved Without (+/-) sign: Saved ^{*1}

*1 The setting "without sign" is only applicable to MB2i series. Please specify the sign (+/-) in normal operation .

[ESC+EP] Print End Position

Hexadecimal code	ESC	EP	Parameter
	<1B> ₁₆	<45> ₁₆ <50> ₁₆	[,aaaaa]
Initial value	Nil		

Valid range and term of command	When the power is OFF	The set command is not maintained.
	Valid range within items	The set command becomes invalid.
	Valid range between items	The set command becomes invalid.

[Function]

Specifying the label stop position in the sensor ignored mode.

[Format]

<EP>[,aaaaa]

- Parameter

a [print stop position] = Refer to the table below.

[Range of specification]

Head density	Length of label(dots)
203 dpi	0 to 8000

[Coding Example]

```
<A>
<A1>14240832
<Z>
<A>
<V>100<H>200<P>2<L>0202<XS>ABCD
<Q>2
```

<EP>

<Z>

Example) 8 dots/mm

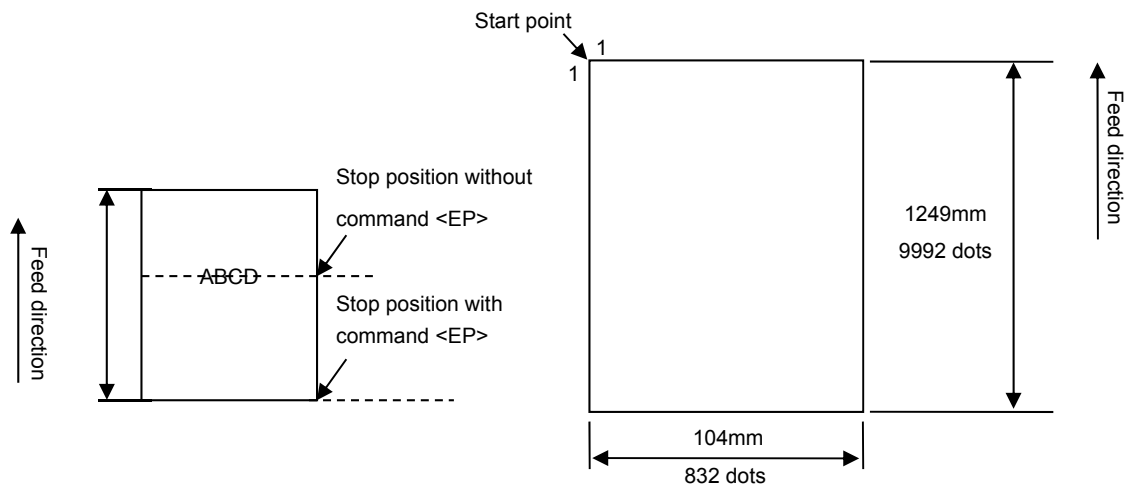

[Coding Sample 2]

```
<A>
<V>100<H>200<P>2<L>0202<XS>ABCD
<Q>2
<EP>,128
<Z>
```

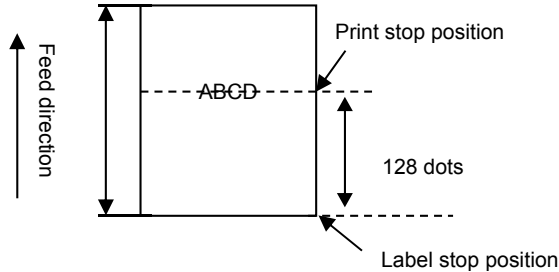

[Supplementary Explanation]

- Use this command in the sensor invalid mode.
- Use this command in combination with Label Size <A1>.
- When you specify the parameter, the last position of printing + value specified in parameter will be the stop position of label.
However, if last position of printing + position specified in parameter exceeds label length, the size is truncated to label length.
- If you specify label size <A1> in Format Registration <YS> and Form Overlay Registration <&S> make sure to specify Print End Position <EP> when you specify Format Call <YR> and Form Overlay Call <&R>.
- The label stop position depends on the following combination. The table below shows which commands will be adopted by the combination of <A1> ~ LCD setting items.

<A1>	<EP>		LCD setting item	Adopted command	Remarks
	Without parameter	With parameter			
○	○	-	-	<A1>	
○	-	○	-	<EP>	
○	-	-	○	LCD(Print End Position)	If you do not specify of the <EP>.
○	○	-	○	<A1>	
○	-	○	○	<EP>	
-	○	-	-	<A1>	If after power ON, <A1> is designated once.
-	○	-	-	LCD(Label Length)	If after power ON, <A1> is not specified even once.
-	-	○	-	<EP>	
-	-	-	○	LCD(Print End Position)	If you do not specify of the <EP>.
-	○	-	○	<A1>	If after power ON, <A1> is designated once.

<A1>	<EP>		LCD setting item	Adopted command	Remarks
	Without parameter	With parameter			
				LCD(Label Length)	If after power ON, <A1> is not specified even once.
-	-	o	o	<EP>	

[ESC+*] Memory Clear

Hexadecimal code	ESC	*	Parameter
	<1B> ₁₆	<2A> ₁₆	a
Initial value	Nil		

Valid range and term of command	When the power is OFF	The set parameter is not maintained.
	Valid range within items	The set parameter becomes invalid.
	Valid range between items	The set parameter becomes invalid.

[Function]

Clears print jobs and specific item in memory.

[Format]

<*>a

- Parameter
 - a Item to be cleared
 - Not specified : Single item buffer, Receive buffer, Edit buffer (reprint is not possible)
Multi item buffer, Receive buffer, Edit buffer (Clears job in parsing)
 - T : User defined characters
 - & : Form overlay
 - X : All clear
(Receive buffer, Edit buffer, User defined characters, form overlay)
Note the job, which is currently in progress, will not be cleared.

[Coding Example1] Clear receive and edit buffer

```
<A>
<*>
<Z>
```

[Coding Example2] All clear

```
<A>
<*>X
<Z>
```

[Coding Example3] Clear user-defined characters

```
<A>
<*>T
<Z>
```

[Supplementary Explanation]

- Set this command between Start code <A> and Stop code <Z>.
- This command <*> (a=X) will clear all the data sent before the command. However, the data which is completely parsed before the command will not be cleared. X will also clear user-defined characters and form overlay.

[Notes]

- After the command <*> is executed, have an interval of more than 100 ms before sending next print data.
- The job in printing will not be terminated by the command <*>.

[ESC+@] Offline

Hexadecimal code	ESC	@	Parameter
	<1B> ₁₆	<40> ₁₆	Nil
Initial value	Nil		

Valid range and term of command	When the power is OFF	The set command is not maintained.
	Valid range within items	The set command becomes invalid.
	Valid range between items	The set command becomes invalid.

[Function]

Set printer offline.

[Format]

<@>

[Coding Example]

<A>
<@>
<Z>

[Supplementary Explanation]

- Set this command between Start code<A> and Stop code<Z>.
- When this command is used at offline state, the printer goes offline when the printer status becomes online next time.

[ESC+C] Reprint

Hexadecimal code	ESC	C	Parameter
	<1B> ₁₆	<43> ₁₆	Nil
Initial value	Nil		

Valid range and term of command	When the power is OFF	The set command is not maintained.
	Valid range within items	The set command becomes invalid.
	Valid range between items	The set command becomes invalid.

[Function]

Specifies to reprint the last label.

[Format]

<C>

[Coding Example]

<A>
<C>
<Z>

[Supplementary Explanation]

- Since the last print data will be cleared by powering off, reprint operation will not be available after the printer rebooted.
- The forced tear-off command <TK> does not execute reprinting.

[Notes]

- In case the print data contains sequential numbering by command <F>, the same number will be printed.

[ESC+E] Auto Line Feed

Hexadecimal code	ESC	E	Parameter
	<1B> ₁₆	<45> ₁₆	aaa
Initial value	Nil		

Valid range and term of command	When the power is OFF	The set parameter is not maintained.
	Valid range within items	The set parameter becomes invalid.
	Valid range between items	The set parameter becomes invalid.

[Function]

Specifies amount of line spacing and CR (Line feed).

[Format]

<E>aaa

- Parameter

a [line spacing] = valid range : 0 to 999 dots

[Coding Example]

<A>

<E>10

<V>100<H>200<P>2<L>0304<XM>ABCDE+CR

FGHIJ+CR

<Q>2

<Z>

[Supplementary Explanation]

- When CR (0DH) is specified, linefeed based on line pitch will be performed.
- Rotation command <%> can be used in combination with this command.
- The command <E> may be used in a job and change the line spacing as necessary.
- Specify this command before designating the consecutive print of 1-line.
- Specifying this command executes the line feed regardless of CR/LF deletion setting.
- Performing auto linefeed by the designation of CR (0DH), print start position of linefeed will be determined based on the pitch specified with <E> and the value specified with Horizontal Print Position <H> designated after <E>. In case that <H> is specified several times after <E>, return position by CR (0DH) will be at the end of <H>.

[Print sample]

<A><E>0
<V>100<H>100
<XM>ABC
<V>100<H>150
<XM>ABC+CR
DEF
<Z>

Font data to specify the base
reference point
<V>100<H>100<XM>ABC

Font data to specify the base
reference point
<V>100<H>150<XM>ABC+CR

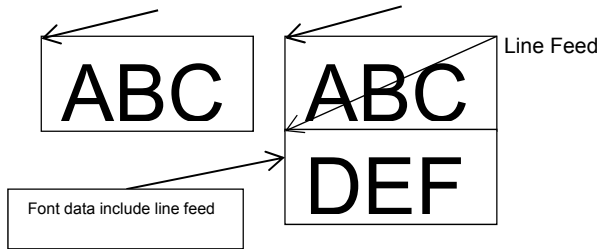

[ESC+PG] Designation of Registration on Printer Motion (MB2i series compatible command)

Hexadecimal code	ESC	E	Parameter
	<1B> ₁₆	<50> ₁₆ <47> ₁₆	abcdefghijklmnopqrs
Initial value	Refer to the table below		

Valid range and term of command	When the power is OFF	The set parameter is not maintained.
	Valid range within items	The set parameter is valid until the next valid setting.
	Valid range between items	The set parameter is valid until the next valid setting.

[Function]

Gives offset to media's stop position on the fly.

[Format]

<PG>abcdefghijklmnopqrs

- Parameter

Using ASCII code for parameter. For the detailed parameter, refer to the table below.

[Coding Example]

<A>

**<PG><33 33 41 31 30 31 30 30 31 32 38 30 30 33 38 34 2B 30 30 31 2B 30 30
31 2B 30 30 2B 30 30 2B 30 30 30 30 30 30 30>₁₆**

<Z>

Describing parameter value in ASCII code.

<30>₁₆<30>₁₆<02>₁₆.....<00>₁₆

[Supplementary Explanation]

- This command is not necessary in the normal label printing operation.
- Operation settings specified with this command are still in effect after turning off the printer.
- The same setting are accessible from the printer setting tool.

[Note]

- This command is for MB2i series. Please use Language Common Command DC2+PA.
- It is required to validate PT compatible setting (COMP_PT_PG) at [SBPL] section of Language Common Command DC2+PA to use this command.

Parameter

No.	Item	Explanation	Digit number	Remarks
a	Print speed	1: Max. 75 mm/sec 2: Max. 103 mm/sec	1	
b	Print darkness level	1: Lightest 2: Light 3: Normal 4: Dark 5: Darkest	1	*1
c	Print darkness range	A to C	1	*1
d	Backfeed (Dispenser)	1: Motion 1 (Head position) 2: Motion 2 (Dispensing position) 3: No backfeed	1	
	Backfeed (Linerless)	1: Head position, no initial paper feed movement 2: Head position, with initial paper feed movement 3: No backfeed, no initial paper feed movement		*2
e	Zero slash	0: Disable 1: Enable	1	
f	Kanji code	0: JIS code 1: Shift JIS code	1	
g	Initial feed	0: Disable 1: Enable	1	
h	Proportional pitch	0: Release of proportional pitch 1: Designation of proportional pitch	1	
i	Height of label	0001 to 1280 dots	4	
j	Width of label	0001 to 0384 dots (4 digits)	4	
k	Vertical start point correction	1st digit: +, - (4 digits) 2nd to 4th digit: 000 to 300	4	
l	Horizontal start point correction	1st digit: +, - (4 digits) 2nd to 4th digit: 000 to 300	4	
m	Label pitch offset	1st digit: +, - (3digits) 2nd to 4th digit: 00 to 99	3	*3
n	Tear-off offset	1st digit: +, - (3digits) 2nd to 4th digit: 00 to 99	3	*3
o	Dispenser offset	1st digit: +, - (3digits) 2nd to 4th digit: 00 to 99	3	*3
p	Auto power off	000: No auto power off (3 digits)	3	

No.	Item	Explanation	Digit number	Remarks
		001 to 999 minutes		
q	Print mode	0 : Label printing mode (1digit) 1 : Journal printing mode (mode 1) 2 : Dual-color Label printing mode 3 : Dual-color Journal printing mode 4 : Linerless label printing mode (mode 1) 5 : Journal printing mode (mode 2) 6 : Linerless label printing mode (mode 2)	1	*4 *5
r	Print operation mode	0: Tear-off (1 digit) 1: Continuous	1	*5
s	Sensor type	0: Reflective sensor (I-mark) (1 digit) 1: See-thru sensor (Gap)	1	*5 *6

*1 The darkness level will be twice as what was set. For darkness, A will be applied for specifying either A, B or C.

Value set with <PG>	Value in PW
1A, 1B, 1C	2A
2A, 2B, 2C	4A
3A, 3B, 3C	6A
4A, 4B, 4C	8A
5A, 5B, 5C	10A

*2 The linerless behavior in PW2 will be limited only to "Head position, no initial feed movement". Therefore, the printer works as "1: Head position, no initial feed movement" even if "2: Head position, with initial feed movement" or "3: No backfeed, no initial feed movement" are set.

*3 The following table explains the behavior of each offset. (range of PT208e)

	Range of PT208 (dots) Valid range with <PG>	Range of PW208m/PW208 (dots)
Label pitch offset	-40 to 99	-90 to 99
Tearoff offset	-99 to 99	-99 to 99
Dispenser offset	-40 to 99	-20 to 99

Note: If a value below -20 is set in dispenser offset, it will be replaced with the minimum range of -20 for PW.

*4 Dual-color printing is out of specification for PW2. When you specify "2: Dual-color Label printing mode", the printer will work as "0: Label printing mode", and when you specify "3: Dual-color Journal printing mode" it will work as "1: Journal printing mode (mode 1)".

*5 The below is the table of combinations for the print mode, print operation mode and sensor type.

Configuration with <PG>			Behavior of PW printer	
q.Print mode	r.Print operation mode	s.Sensor type	Print operation	Sensor type
0: Print label	0: Tear-off	0: I-Mark sensor	Tear-off	I-Mark sensor
2: Dual-color Label printing		1: Gap sensor		Gap sensor

Configuration with <PG>			Behavior of PW printer	
q.Print mode	r.Print operation mode	s.Sensor type	Print operation	Sensor type
	1: Continuous	0: I-Mark sensor	Continuous	I-Mark sensor
		1: Gap sensor		Gap sensor
4: Linerless printing 5: Dual-color linerless printing 6: Linerless printing mode (Motion 2)	-	-	Linerless	I-Mark sensor
1: Journal printing	0: Tear-off	-	Tear-off	Sensor disabled
3: Dual-color journal printing mode	1: Continuous	-	Continuous	Sensor disabled

*6 The GAP sensor cannot be specified for PW208mNX. The old value stays instead.

[ESC+PO] Offset

Hexadecimal code	ESC	PO	Parameter
	<1B> ₁₆	<50> ₁₆ <4F> ₁₆	abcc
Initial value	a=0, b=+, cc=00		

Valid range and term of command	When the power is OFF	The set parameter is not maintained.
	Valid range within items	The set parameter is valid until the next valid setting.
	Valid range between items	The set parameter is valid until the next valid setting.

[Function]

Gives offset to media's stop position on the fly.

[Format]

<PO>abcc

- Parameter
 - a Offset
 - 1 : Dispenser
 - 2 : Tear-off
 - 3 : Continuous
 - 4 : Linerless
 - b Offset direction
 - + : Feed forward
 - : Backward
 - c Amount of offset = Valid range : 00 to 99 (dot)

[Coding Example]

<A>
<PO>3+08
<Z>

[Supplementary Explanation]

- This command does not need to be set in normal printing.
- Please specify an appropriate value when the printing is off, which is unique for each printer. Printer will not work properly if you do not specify appropriate value.

[ESC+IG] Sensor Type

Hexadecimal code	ESC	IG	Parameter
	<1B> ₁₆	<49> ₁₆ <47> ₁₆	a
Initial value	a=1		

Valid range and term of command	When the power is OFF	The set parameter is maintained.
	Valid range within items	The set parameter is valid until the next valid setting.
	Valid range between items	The set parameter is valid until the next valid setting.

[Function]

Specifies the sensor type.

[Format]

<IG>a

- Parameter
 - a [Sensor type]
 - 0 : Reflective (I-mark)
 - 1 : Transmissive (Gap)
 - 2 : Sensor disabled

[Coding Example]

<A>
<IG>1
<Z>

[Supplementary Explanation]

- The setting by this command is normally not needed.
- The set parameter is maintained after turning off the printer.
- Do not use this command while printing operation as sensor may not work properly.
- Receiving print command after changing the sensor type executes printing after backfeed except specifying the "ignore sensor" to the sensor type. Feed motion is not performed after turning the printer's power off and then power on.
- When printer operation mode is set to [Dispense], the range will be available only in 0: Reflective sensor (I-MARK), and 1: Transmissive sensor (GAP). There will be no command error when 2:Ignore sensor is specified. In this case, no value will be set.
- When printer operation mode is set to [Linerless cutter], the range will be available only in 0: Reflective sensor (I-MARK) and 2: Ignore sensor. When 1: Transmissive sensor (GAP) is specified, there will be no command error. In this case, no value will be set.
- No value will be set when 1: Transmissive sensor (GAP) is specified because PW208mNX does not have any transmissive sensors (GAP).

[ESC+PM] Print mode

Hexadecimal code	ESC	PM	Parameter
	<1B> ₁₆	<50> ₁₆ <4D> ₁₆	a
Initial value	a=0		

Valid range and term of command	When the power is OFF	The set parameter is maintained.
	Valid range within items	The set parameter is valid until the next valid setting.
	Valid range between items	The set parameter is valid until the next valid setting.

[Function]

Specifies print mode.

[Format]

<PM>a

- Parameter
 - a Print mode
 - 0 : Continuous
 - 1 : Tear-off
 - 7 : Dispenser (head position)
 - 8 : Dispenser (dispenser position)
 - C : Linerless (tear-off position)
 - D : Dispenser (no backfeed)

[Coding Example]

```
<A>
<PM>0
<Z>
```

[Supplementary Explanation]

- The valid print operation mode depends on printer model.

Model	Specify print operation mode
PW208mNX	Continuous, Tear-off, Linerless (tear-off position)
PW208NX	Continuous, Tear-off, Dispenser (head position), Dispenser (dispenser position) Linerless (tear-off position), Dispenser (no backfeed)

Printer does not shift to the specified print operation mode if anything other than the above is specified.

- The below explains how each print operation mode works.

(0) Continuous

The printer stays still after printing.

(1) Tear-off

The media will be fed up to the tear-off edge after printed. Then the printer, after receiving next print data, will back feed the next label to the print head position.

(7) Dispense (Head position)

Back feeds the labels to head position after dispensing.

(8) Dispense (Dispense position)

The media will be fed up to the head position after data receiving and the label will be fed to the dispense position after printing.

(C) Linerless cutter operation (tear-off position)

The media will be fed up to the head position after data receiving and the label will be fed to the dispense position after printing.

(D) Dispense(No back feed)

No back feed.

- PW208mNX dispenser mode is set automatically when the cover is closed. (Printer will be set to dispenser mode when you have the dispenser bar on the dispenser mode position) Backfeed motion needs to be set if you specify dispenser with this command.

[ESC+KM] Mincho (Kanji)

Hexadecimal code	ESC	KM	Parameter
	<1B> ₁₆	<4B> ₁₆ <4D> ₁₆	Nil
Initial value	Nil		

Valid range and term of command	When the power is OFF	The set parameter is maintained.
	Valid range within items	The set parameter is valid until the next valid setting.
	Valid range between items	The set parameter is valid until the next valid setting.

[Function]

Sets Kanji font style to Mincho.

[Format]

<KM>

[Coding Example]

<A>
<KM>
<V>100<H>200<P>2<L>0304
<K1>H82508A94816A83548367815B
<KG>
<V>200<H>200<P>2<L>0304
<K1>H82508A94816A83548367815B
<Q>2
<Z>

[Supplementary Explanation]

- This command can be used more than once in single item.

[ESC+KG] Gothic (Kanji)

Hexadecimal code	ESC	KG	Parameter
	<1B> ₁₆	<4B> ₁₆ <47> ₁₆	Nil
Initial value	Nil		

Valid range and term of command	When the power is OFF	The set parameter is maintained.
	Valid range within items	The set parameter is valid until the next valid setting.
	Valid range between items	The set parameter is valid until the next valid setting.

[Function]

Sets Kanji font style to Gothic.

[Format]

<KG>

[Coding Example]

```
<A>  
<KG>  
<V>100<H>200<P>2<L>0304  
<K1>H82508A94816A83548367815B  
<KG>  
<V>200<H>200<P>2<L>0304  
<K1>H82508A94816A83548367815B  
<Q>2  
<Z>
```

[Supplementary Explanation]

- This command can be used more than once in single item.

[ESC+CE] European code page

Hexadecimal code	ESC	CE	Parameter
	<1B> ₁₆	<43> ₁₆ <45> ₁₆	a...a(,b)
Initial value	Nil		

Valid range and term of command	When the power is OFF	The set parameter is maintained.
	Valid range within items	The set parameter is valid until the next valid setting.
	Valid range between items	The set parameter is valid until the next valid setting.

[Function]

Specify the European code page to be used.

[Format]

<CE>a...a(,b)

- Parameter

a [Code page name] = Valid range : refer to the [Code page parameter] in the next page.

b [Code page setting maintain] = Valid range : P (fixed)

Specify [P] to retain selected code page. (omissible)

When omitted, the selected code page is not retained.

[Coding Example1] Win 1253 setting

```
<A>
<V>100<H>200<P>2<L>0304<CE>1253<XU>ABCDE
<Q>2
<Z>
```

[Coding Example1] DOS 855 setting

```
<A>
<V>100<H>200<P>2<L>0304<CE>855<XU>ABCDE
<Q>2
<Z>
```

[Code page parameter]

Parameter a	Official name	Supplemental explanation
858	DOS 858	Multilingual Latin 1 + Euro character Default Code page proprietary to SATO.
88591	ISO 8859/1	ISO 8859-1 Latin 1
88592	ISO 8859/2	ISO 8859-2 Latin 2
88599	ISO 8859/9	ISO 8859-9 Latin 5
850	DOS 850	Latin 1 Multilingual
852	DOS 852	Latin 2
855	DOS 855	Cyrillic
857	DOS 857	Turkish

Parameter a	Official name	Supplemental explanation
737	DOS 737	Greek
866	DOS 866	Cyrillic II
1250	Win 1250	Central Europe
1251	Win 1251	Cyrillic
1252	Win 1252	Western Latin 1
1253	Win 1253	Greek
1254	Win 1254	Turkish
1257	Win 1257	Baltic
869	IBM 869	IBM 869 Greek
201	X0201	Japanese X0201
UTF-8	UTF-8	Unicode encoding in UTF-8

[Code page support font]

Following bitmap fonts are extended for supporting European code page.

Font name	Size	Font type
U	5x9	Helvetica
S	8x15	Universal Condensed
M	13x20	Universal Condensed
WB	18x30	Universal
WL	28x52	Sans Serif Bold
XU	5x9	Helvetica
XS	17x17	Universal Condensed Bold
XM	24x24	Universal Condensed Bold
XB	48x48	Universal Condensed Bold
XL	48x48	Universal

Refer to the European code page specification for the print character set.

[ESC+TK] Forced Tear Off

Hexadecimal code	ESC	TK	Parameter
	<1B> ₁₆	<54> ₁₆ <4B> ₁₆	Nil
Initial value	Nil		

Valid range and term of command	When the power is OFF	The set parameter is not maintained.
	Valid range within items	The set parameter becomes invalid.
	Valid range between items	The set parameter becomes invalid.

[Function]

Executes Tear off compulsory.

[Format]

<TK>

[Coding Example]

<A>
<TK>
<Z>

[Supplementary Explanation]

- This command can be specified only in Tear off mode.
- With this command, the printer executes Tear off motion without waiting the time set by command <ESC+TW>. If the next data is received before Tear off motion, Tear off is executed compulsory.
- This command cannot be used in combination with other commands. Please send the command independently.

[Notes]

- This command can be used to shorten print time set at Option Waiting Time, if it is sure that there is no following item.

[ESC+TW] Option Waiting Time

Hexadecimal code	ESC	TW	Parameter
	<1B> ₁₆	<54> ₁₆ <57> ₁₆	aaa
Initial value	aaa = 000		

Valid range and term of command	When the power is OFF	The set parameter is maintained.
	Valid range within items	The set parameter becomes invalid.
	Valid range between items	The set parameter becomes invalid.

[Function]

Specifies waiting time for optional device.

[Format]

<TW>aaa

- Parameter

aaa [Waiting time] = Valid range : 000, 005 to 200 (unit: 100ms)

[Coding Example] (waiting time = 1.5 seconds)

<A>

<TW>015

<Z>

[Supplementary Explanation]

- This command specifies, in Tear-off mode, the waiting time between print completion and Tear-off motion.
- The set parameter becomes valid soon after receiving the command and will be retained after power off.

[ESC+CL] Delete CR/LF

Hexadecimal code	ESC	CL	Parameter
	<1B> ₁₆	<43> ₁₆ <4C> ₁₆	a
Initial value	Nil		

Valid range and term of command	When the power is OFF	The set parameter is maintained.
	Valid range within items	The set parameter is valid until the next valid setting.
	Valid range between items	The set parameter is valid until the next valid setting.

[Function]

Deletes CR/LF included in print commands.

[Format]

<CL>a

- Parameter
 - a [Delete CR/LF]
 - 0 : Do not delete CR/LF
 - 1 : Deletes CR/LF

[Coding Example]

<A>
<CL>1
<Z>

[Supplementary Explanation]

- Delimit Start of Data Transmission <A> and End of Data Transmission <Z> with this command for use.
- This command cannot be used in combination with other commands.

Intelligent Command

[ESC+IK] Label Feed Control

Hexadecimal code	ESC	IK	Parameter
	<1B> ₁₆	<49> ₁₆ <4B> ₁₆	a(,bbbb)
Initial Value	Nil		

Valid range and term of command	When the power is OFF	The set parameter is not maintained.
	Valid range within items	The set parameter becomes invalid.
	Valid range between items	The set parameter becomes invalid.

[Function]

Feeding forward or backward for the specified number of labels.

[Format]

<IK>a(,bbbb)

- Parameter

a [Feed direction]

0 : Forward feed

1 : Backfeed

b [Number of label feed]

Valid Range : Refer to the table described below. (Omissible only for forward feed.)

Feeds one label when omitting this parameter.

[Coding Example1]

When 120 dots feeding forward the media

<A>

<IK>0,120

<Z>

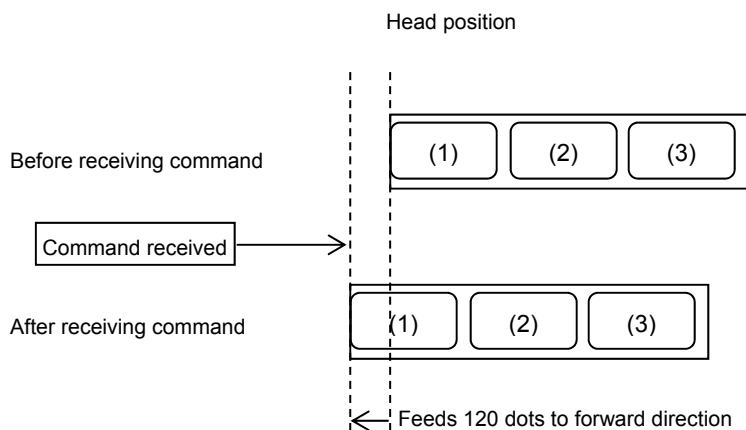

When print data is received without returning to the original position with <IK>1,120, printing will start from the current stop position.

[Coding Example2]

When feeding one label

```
<A>
<IK>0
<Z>
```

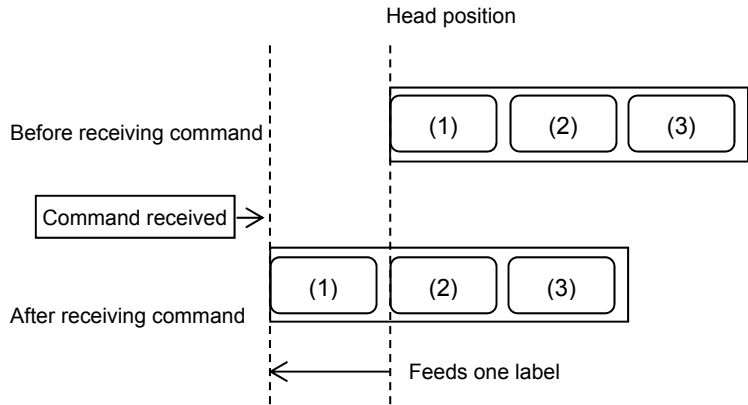

[Supplementary Explanation]

- Delimit Start of Data Transmission <A> and End of Data Transmission <Z> with this command. When specifying this command with the same item as print data, the command will be ignored.
- When setting [Label feed direction] to [1: Backfeed], length of label feed needs to be checked. If this length is very long, it may cause overlapped prints or label may fall off the platen and result in detection error as paper-end.
- When omitting [No. of label feed] in forward feed, printer motion will be similar to label feed motion when pressing the FEED key in offline state.
- Label feed motion with this command will be activated at the time of online.
- When omitting [No. of label feed] in backfeed, label feed will not be performed due to command error.
- When the specified feed value is outside of valid range, printing will not be performed due to command error.
- Actual feed distance may be different from the set value according to the individual difference of each printer, supplies and operating environment. Recommend to adjust the feed value before operation.
- In cutter and dispenser mode, do not attempt to backfeed right after cutting and dispensing label.
- Printer always feeds 20 mm of label using <IK>0 (omit the amount of feeding label) when sensor is set to disabled.

[Valid Range]

Head density	Media feed direction = Forward direction feed length (dots)	Media feed direction = Backward direction feed length (dots)
203 dpi	20 to 1600	20 to 100

Common commands for all languages

The common commands are the commands independent from the applications such as SBPL, SZPL.

The common specifications of the common command for all languages will be described as follows.

- The structure begins from [DC2]<12>₁₆ and two characters follow it.
- When the two characters follow [DC2] are not the common commands, nothing will be returned and the data after that will be ignored.
- The command to specify the data size will wait the data until the data size satisfies the specified size and no data will be returned.
- When initializing the printer, turning the printer's power off and updating the printer, [NAK]<15>₁₆ will be returned. However, the cancel request command can be received.
- It runs after resuming from power-save mode when the printer is in power-saving mode or resuming from power-save mode, and returns [ACK]<06>₁₆ or [NAK]<15>₁₆. However, the reset command and the power off command and the cancel request command can be received.
- The common commands cannot be used when the printer is set to the non-standard mode.

[DC2+PA] Printer setting command

Command	DC2	PA	Parameter
Hexadecimal code	<12> ₁₆	<50> ₁₆ <41> ₁₆	a...a,bb,c...c,d...d,(,ee,f...f,g...g,h...h,i...i)...
Initial Value	None		

Valid range and term of command	When turning off the power	The set parameter is maintained.
	Valid range	The set parameter is valid until the next setting.
	Printer operation in progress	The command cannot be received during the printer operation. ([NAK] return)
	Error	Commands cannot be received even if an error is occurring. ([NAK] return)

[Function]

These are commands to save printer settings.

[Format]

DC2(12H) + PA,a...a,bb,c...c,d...d,(,ee,f...f,g...g,h...h)...

Data sample)

[PA], PA,87,CA,35,SPEED:2

LABELV:12345

LABELH:456

,SB,39,ZEROSLASH:0

SHOTAI:0

PROPORTIONAL:0

[Parameters]

Symbol	Parameter name	Valid range	Acquisition method
a	Total number of data in bytes * Total number of data in bytes after parameter "b". Does not include the comma in between parameter "a" and "b".	0 to 524277	Acquire until ",",
b(e...)	Identifier	CA: Common settings CB: Notification system IL: LAN settings IU: USB settings IW: WLAN settings IB: Bluetooth settings IN: NFC settings * IN is only for PW208NX/ PW208mNX. SB: SBPL setting SZ: SZPL settings SP: SPOS settings (reserve)	Acquire fixed two-character

Symbol	Parameter name	Valid range	Acquisition method
		SC: SCPL settings (reserve)	
c(f...)	Data size of settings in bytes * The size of setting information is equivalent to the bytes by section from parameter d. The comma in between the sections is not included.	0 to 524277	Acquire until ",",
d(g...)	Setting data * text format * Items that need to be encrypted to perform encryption	Refer to the table of [Setting data] below.	Data sized of setting information

[Setting data format]

"Name of setting item" + ":" + "Setting data" + "Line feed(0DH, 0AH)"

h...h:i...i[CR][LF](j...j:k...k[CR][LF])...

[Setting data]

Symbol	Parameter name	Valid range	Acquisition method
h(j ...)	Setting item	See Settings Table	Valid until ":"
i(k ...)	Setting data	See Settings Table	Valid until "[CR][LF]"

Data sample)

SPEED:4

LEVEL:5

[Return data format (normal)]

[ACK]<06>₁₆

[Return data format (when a command error occurs)]

[NAK]<15>₁₆

[Exception processing]

Parameter name	Exception condition	
	A value outside the range is specified	The specified size and received size are different
Total number of data in bytes	Command Error	Command Error *1 *2
Identifier	Invalid identifier (skip)	Command Error
Data size of settings in bytes	Command Error	Command Error *3
Setting item	Invalid setting item (skip)	
Setting data	Invalid setting item (skip)	

*1 If the data size from the first identifier (bb) to the last data item does not match the data size of setting information, and the data size calculated from the format, a command error will occur.

*2 However, nothing will be returned until receiving the number of data equals to the total number of data bytes.

*3 If the data during the receipt of the setting information data size from the beginning of the setting information data is not ",", a command error occurs.

Terminology	Description
Command Error	All items are not set. The data received after a command error is determined is not considered as a parameter of this command.
Invalid identifier	The corresponding setting information data (data equivalent to the succeeding setting information data size) is ignored.
Invalid item	The data of one item (data up to [CR] [LF]) is ignored.

[Supplementary information]

- If the sum of the total data size and configuration information data size does not match, an error will occur and they will not be set.
- If the data size of settings and data size of actual settings do not match, an error will occur and the value will not be set.
- Setting for each identifier and setting item can be omitted.
- Setting for each identifier and setting item can be in random order.
- When re-setting a setting with same identifier, the last value that was set will be enabled.
- If the value in setting was out of range, then the setting item will have an error and will be skipped.
- No malfunction will occur when a character string with the same name as the setting item was set.
e.g.) When you set "DeviceName" as setting value for the setting item named "DeviceName".
- Do not send this command when the printer is printing. Use this command in the standby status.

[Setting saving function]

This command proceeds the setting when the item name and the setting value were specified basically. However, the problem may occur when the setting data are set in order of receiving the data because the setting item can be omitted and set in random order. These items will be saved firstly and set after all the received data were analyzed.

The target items and their setting process are described as follows.

Target item	Setting process											
[PRINTER] Time zone [PRINTER] Date [PRINTER] Time	The time zone must be set firstly because the time difference calculated from the local time is necessary for setting the date and time.											
[PRINTER] Main port [PRINTER] Sub port	Settings of the main port and sub-port cannot be duplicated, and the duplicated code will be ignored.											
[BLUETOOTH] ISI [BLUETOOTH] ISW [BLUETOOTH] PSI [BLUETOOTH] PSW	<ul style="list-style-type: none"> • When "ISI" is smaller than "ISW", it is not set. • There is a function that when "0" is set to both "ISI" and "ISW", Bluetooth module does not respond to the search. Regarding this function, to avoid conflicting settings, setting it under following condition. <table border="1" data-bbox="735 1832 1431 2033"> <thead> <tr> <th>ISI</th> <th>ISW</th> <th>Process</th> </tr> </thead> <tbody> <tr> <td rowspan="2">="0"</td> <td>= "0"</td> <td>Set</td> </tr> <tr> <td>≠ "0"</td> <td>Do not set</td> </tr> <tr> <td>≠ "0"</td> <td>= "0"</td> <td>Do not set</td> </tr> </tbody> </table>	ISI	ISW	Process	="0"	= "0"	Set	≠ "0"	Do not set	≠ "0"	= "0"	Do not set
ISI	ISW	Process										
="0"	= "0"	Set										
	≠ "0"	Do not set										
≠ "0"	= "0"	Do not set										

Target item	Setting process			
		ISI	ISW	Process
			≠"0"	Set
	<ul style="list-style-type: none"> When "PSI" is smaller than "PSW", it is not set. 			
[BLUETOOTH] Delete pairing information	There are 10 pairing information and they are arrayed. You cannot delete them one by one because the deleted area is filled with next data and the number will be inconsistent. You can delete the data when you know all the pairing information to be deleted.			
[SBPL] STX [SBPL] ETX [SBPL] ESC [SBPL] ENQ [SBPL] CAN [SBPL] NULL [SBPL] OFFLINE	Each control code cannot be duplicated, and the duplicated code will be ignored.			
[SZPL] Command Head [SZPL] Control head [SZPL] Delimiter	Each control code cannot be duplicated, and the duplicated code will be ignored.			

[Encryption of data]

The method for encryption shall be bit inversion plus conversion of binary to ASCII. Therefore there will be twice as much data after encryption.

Table) Table of encryption code

Original		Encrypted		Original		Encrypted		Original		Encrypted	
Character	code [HEX]	Character (SJIS)	code [HEX]	Character	code [HEX]	Character (SJIS)	code [HEX]	Character	code [HEX]	Character (SJIS)	code [HEX]
Space	20	df	64 66	@	40	bf	62 66	`	60	9f	39 66
!	21	de	64 65	A	41	be	62 65	a	61	9e	39 65
"	22	dd	64 64	B	42	bd	62 64	b	62	9d	39 64
#	23	dc	64 63	C	43	bc	62 63	c	63	9c	39 63
\$	24	db	64 62	D	44	bb	62 62	d	64	9b	39 62
%	25	da	64 61	E	45	ba	62 61	e	65	9a	39 61
&	26	d9	64 39	F	46	b9	62 39	f	66	99	39 39
'	27	d8	64 38	G	47	b8	62 38	g	67	98	39 38
(28	d7	64 37	H	48	b7	62 37	h	68	97	39 37
)	29	d6	64 36	I	49	b6	62 36	i	69	96	39 36
*	2A	d5	64 35	J	4A	b5	62 35	j	6A	95	39 35
+	2B	d4	64 34	K	4B	b4	62 34	k	6B	94	39 34
,	2C	d3	64 33	L	4C	b3	62 33	l	6C	93	39 33
-	2D	d2	64 32	M	4D	b2	62 32	m	6D	92	39 32
.	2E	d1	64 31	N	4E	b1	62 31	n	6E	91	39 31
/	2F	d0	64 30	O	4F	b0	62 30	o	6F	90	39 30

Original		Encrypted		Original		Encrypted		Original		Encrypted	
Character	code [HEX]	Character (SJIS)	code [HEX]	Character	code [HEX]	Character (SJIS)	code [HEX]	Character	code [HEX]	Character (SJIS)	code [HEX]
0	30	cf	63 66	P	50	af	61 66	p	70	8f	38 66
1	31	ce	63 65	Q	51	ae	61 65	q	71	8e	38 65
2	32	cd	63 64	R	52	ad	61 64	r	72	8d	38 64
3	33	cc	63 63	S	53	ac	61 63	s	73	8c	38 63
4	34	cb	63 62	T	54	ab	61 62	t	74	8b	38 62
5	35	ca	63 61	U	55	aa	61 61	u	75	8a	38 61
6	36	c9	63 39	V	56	a9	61 39	v	76	89	38 39
7	37	c8	63 38	W	57	a8	61 38	w	77	88	38 38
8	38	c7	63 37	X	58	a7	61 37	x	78	87	38 37
9	39	c6	63 36	Y	59	a6	61 36	y	79	86	38 36
:	3A	c5	63 35	Z	5A	a5	61 35	z	7A	85	38 35
;	3B	c4	63 34	[5B	a4	61 34	{	7B	84	38 34
<	3C	c3	63 33	\	5C	a3	61 33		7C	83	38 33
=	3D	c2	63 32]	5D	a2	61 32	}	7D	82	38 32
>	3E	c1	63 31	^	5E	a1	61 31	~	7E	81	38 31
?	3F	c0	63 30	_	5F	a0	61 30				

[A list of setting items]

[PRINTER] section

Name of Setting item	Setting value	Default Vale.	R/W	initial	Contents of Setting item
				CA	
SPEED	"3": 3inches/sec "4": 4inches/sec "5": 5inches/sec "6": 6inches/sec (Linerless : 3-4) (Dispenser : 3-4)	4	R/W	○	Print speed <CS>
LEVEL	"1": Darkness 1 "2": Darkness 2 "3": Darkness 3 "4": Darkness 4 "5": Darkness 5 "6": Darkness 6 "7": Darkness 7 "8": Darkness 8 "9": Darkness 9 "10": Darkness 10	5	R/W	○	Print darkness level <#F>
CONCENTRATION	"A" "B" "C" "D" "E" "F"	A	R/W	○	Print darkness <#F>
LABELV	"1" to "8000"(dot)	1760	R/W	○	Vertical size of label
LABELH	"1" to "440"(dot)	440	R/W	○	Horizontal size of label
PITCHOFFSET	"-99" to "99"(dot)	0	R/W	○	Pitch offset
BASEV	"-300" to "300"(dot)	0	R/W	○	Pitch offset
BASEH	"-300" to "300"(dot)	0	R/W	○	Offset of vertical base reference point <A3>
PRINT	"0": Continuous "1": Tear-off "4": Linerless	0	R/W	○	Offset of horizontal base reference point <A3>
PEEL	"0": Motion 3 (No backfeed) "1": Motion 1 (Thermal head position) "2": Motion 2 (Dispenser position)	1	R/W	○	Dispenser motion (backfeed motion) <PM>
NONSEPA	"2": Motion 2 (Dispenser position)	2	R/W	○	Linerless motion (Backfeed motion) <PM>
TEAR_OFFSET	"-99" to "99" (dot)	0	R/W	○	Tear-off Offset adjust <PO>
DISP_OFFSET	"-99" to "99" (dot)	0	R/W	○	Dispenser Offset adjust <PO>
TYPE	"1": Direct thermal	1	R/W	○	Print method <PH>
SENSOR	PW208NX: "0": Disable sensor "1": GAP "2": I-MARK PW208mNX: "0": Disable sensor "2": I-MARK (Continuous or Tear-off : 0,1,2) (Linerless : 0,2) (Dispenser : 1,2)	PW208NX : 2 PW208mNX : 0	R/W	○	Sensor type <IG> Sensor value of the active print mode.

[PRINTER] section

Name of Setting item	Setting value	Default Vale.	R/W	initial	Contents of Setting item
				CA	
PEND_TYPE	PW208NX: "0": I-MARK "1": GAP PW208mNX "0": I-MARK	0	R/W	○	Type of paper end sensor * NAK returns when GAP is selected at PW208mNX.
MEDIA_CHECK	"0": Disable "1": Enable	0	R/W	○	Media check
HEADCHECK	"0": Disable "1": Normal range "2": Barcode range	1	R/W	○	Head check mode
HEADCHECK_MODE	"0": Check one page "1": Specify start and end "2": Specify number of pages	0	R/W	○	Head check mode
HEADCHECK_PAGE	"1" to "9999"	1	R/W	○	Number of headcheck pages
LANGUAGE	"0": English "22": Japanese	0	R/W	○	Language settings
POWER_SAVE	0: Disable 5 to 999 sec	5	R/W	○	Power saving setting
BUZZER	"0": /Buzzer off "3": /Buzzer on	3	R/W	○	Buzzer volume
ADJUSTPITCH	"-30" to "30"(dot)	0	R/W	-	Adjust print position
ADJUSTOFFSET	"-30" to "30"(dot)	0	R/W	-	Offset adjust
OPTIONTIME	"0", "5" to "200"(x 100 ms)	0	R/W	○	Waiting time in tearoff mode for next data <TW>
AUTO_ONLINE	"0": Disable "1": Enable	1	R/W	○	Automatic measurement of label length
FEED	"0": Disable "1": Enable	0	R/W	○	Initial feed
ONLINE_FEED	"0": Disable "1": Enable	0	R/W	○	Online feed <LF>
IGNORE_CRLF	"0": Do not remove CR/LF "1": Remove CR/LF	0	R/W	○	Ignore CR/LF <CL>
BYTECOMMAND	"0": Disable "1": Enable	0	R/W	○	Remove CAN/DLE <1B>
IMLVL_RL	"0" to "127": reflective sensor level (Receiving light)	63	R/W	-	Adjust reflective sensor level (Receiving light)
IMLVL_LE	"0" to "3": reflective sensor level (Light emission)	2	R/W	-	Adjust reflective sensor level (Light emission)
IM_SL	"0.0": Automatic setting "0.1" to "3.3": Manual setting	0.0	R/W	-	Reflective sensor slice level
GAPLVL_RL	PW208NX: "0" to "127": transmissive sensor level(Receiving light) PW208mNX: None	63	R/W	-	Adjust transmissive sensor level (Receiving light)
GAPLVL_LE	PW208NX: "0" to "7": transmissive sensor level (Light emission) PW208mNX: None	4	R/W	-	Adjust transmissive sensor level (Light emission)

[PRINTER] section

Name of Setting item	Setting value	Default Vale.	R/W	initial	Contents of Setting item
				CA	
GAP_SL	PW208NX: "0.0": Automatic setting "0.1" to "3.3": Manual setting PW208mNX:None	0.0	R/W	-	Transmissive sensor slice level
PRIORITY	"0": Prioritize command "1": Prioritize LCD setting	0	R/W	○	Priority setting
PRINT_AREA	"0": Normal	0	R/W	○	Move printing area
ADJUSTDARK	"0" to "99"	50	R/W	-	Adjust darkness
OP_FEED	"0" to "2040"(dot)	0	R/W	○	Optional feed volume
PASS_SET	"0": Disable "1": Enable	0	R/W	-	Input password
ALL_QTY	"0": Disable "1": Enable	0	R/W	○	Display total number of labels to print
HEX_DUMP_MODE	"0": Disable "1": Enable	0	R/W	○	HEX DUMP MODE of Enable/Disable
APP_MODE	"SB": SBPL "SZ": SZPL "SP": SPOS "SC": SCPL * PW208NX/208mNX only	-	R	-	Application mode
APP_MODE_AUTO	"SB": SBPL "SZ": SZPL "SP": SPOS "SC": SCPL * PW208NX/208mNX only	-	R	-	Application mode of AUTO mode
REPRINT	"0": Disable "1": Enable	0	R/W	○	Reprint
INSTALL_SECURITY	"0": Disable "1": USB "2": Always	0	R/W	-	Install Security Password control for pkg install
PRINTEND_POSITION	"0" to "8000"(dot)	0	R/W	○	Print End Position
LEVEL_BAR	"1": Darkness 1 "2": Darkness 2 "3": Darkness 3 "4": Darkness 4 "5": Darkness 5 "6": Darkness 6 "7": Darkness 7 "8": Darkness 8 "9": Darkness 9 "10": Darkness 10	5	R/W	○	Print darkness level (Barcode) <#F>
CONCENTRATION_BAR	"A" "B" "C" "D" "E" "F"	A	R/W	○	Print darkness (barcode) <#F>
DISPLVL_RL	PW208NX: 0 to "31": Adjust reflective sensor level (Receiving light) PW208mNX: None	16	R/W	-	Adjust reflective sensor level (Receiving light)
DISPLVL_LE	PW208NX: "0" to "7": Adjust reflective sensor level (Light emission) PW208mNX: None	4	R/W	-	Adjust reflective sensor level (Light emission)

[PRINTER] section

Name of Setting item	Setting value	Default Vale.	R/W	initial	Contents of Setting item
				CA	
PRINT_CONTROL	"0": reserved "1": reserved "2": reserved	0	R/W	○	Print control settings(reserved)
DISPENSE_MODE	PW208NX: "0": Auto "2": Disable PW208mNX: "1": Manual "2": Disable	PW208NX: 0 PW208mNX: 2	R/W	○	Sets dispenser behavior
AUTO_POWER_OFF	"0": Disable 1 to 999 (sec)	0	R/W	○	Turns off power automatically
LARGE_ICON	"0": Disable "1": Enable	0	R/W	○	Shows large icons
ECO_CHARGE	"0": Disable "1": Enable	0	R/W	○	Ecological charging
FULL_CHARGE_OF F	"0": Disable "1": Enable	1	R/W	○	Turns off power after full charge
COLD_MODE	"0": Disable "1": Enable	0	R/W	○	Controls low temperature printing
LINELVL_RL	PW208NX: "0" to "31": Adjusts linerless sensor level (reception) PW208mNX: None	16	R/W	-	Adjusts linerless sensor level(reception)
LINELVL_LE	PW208NX: "0" to "7": Adjusts linerless sensor level (emission) PW208mNX: None	4	R/W	-	Adjusts linerless sensor level(emission)
POWER_SAVE2	0: Disable 5 to 999 (sec)	PW208NX/PW208mNX: 5	R/W	○	Power saving setting 2
ACTIVE_PRINT	"0": Continuous "1": tear-off "2": Dispenser "4": Linerless	1	R	-	Active print motion
ACTIVE_SENSOR	"0": Disable sensor "1": GAP "2": I-MARK (Continuous or Tear-off : 0,1,2) (Linerless : 0,2) (Dispenser : 1,2)	PW208NX: 2 PW208mNX: 0	R	-	Active Sensor type * NAK is returned when GAP is selected for PW208mNX
SENSOR_CONTINUOUS	"0": Disable sensor "1": GAP "2": I-MARK	PW208NX: 2 PW208mNX: 0	R/W	○	Sensor type (Continuous) <IG>
SENSOR_TEAROFF	"0": Disable sensor "1": GAP "2": I-MARK	PW208NX: 2 PW208mNX: 0	R/W	○	Sensor type (Tear-off) <IG>
SENSOR_PEEL	PW208NX: "0": Disable sensor "1": GAP "2": I-MARK PW208mNX: None	2	R/W	○	Sensor type (Dispenser) <IG>
SENSOR_LINERLESS	"0": Disable sensor "2": I-MARK	2	R/W	○	Sensor type (Linerless) <IG>
UNIT	"0": Dot "1": inch "2": mm	0	R/W	○	Unit * Only applicable to PW208NX/ PW208mNX

[COUNT]

Name of Setting item	Setting value	Default Vale.	R/W	initial	Contents of Setting item
				CB	
PRTCLN	"0": Disable "1": Enable	0	R/W	○	Notification for printer cleanup
PRTCLN_ITV_COUNT	"10" to "1000" (m)	150	R/W	○	Distance to display notification for printer cleanup
PRTCLN_COUNT	"XXXX" *Unit: 1 / 24 mm	-	R	-	Cleaning distance
HDCHG	"0": Disable "1": Enable	0	R/W	○	Notification for replacing thermal head
HDCHG_ITV_COUNT	"10" to "100" (km)	30	R/W	○	Distance to display notification for replacing thermal head
HDCHG_COUNT	"XXX" * Unit: 1 / 24 mm	-	R	-	Print distance of a thermal head
ROLLER	"0": Disable "1": Enable	0	R/W	○	Notification for replacing platen roller
ROLLER_ITV_COUNT	"10" to "100" (km)	30	R/W	○	Distance to display notification for replacing platen roller
ROLLER_COUNT	"XXX" * Unit: 1 / 24 mm	-	R	-	Distance of the platen roller
BATTERY_CYCLE_COUNT	"XXX"	-	R	-	Battery cycle count

[LAN]

Name of Setting item	Setting value	Default Vale.	R/W	initial	Contents of Setting item
				IL	
DHCPv4	PW208NX: "0": Disable "1": Enable PW208mNX: None	1	R/W	-	DHCPv4 setting
IPv4_ADDRESS	PW208NX: AAA.BBB.CCC.DDD Allow "0" to "255" for A – D PW208mNX: None	0.0.0.0	R/W	-	IPv4 Address
IPv4_SUBNETMASK	PW208NX: AAA.BBB.CCC.DDD Allow "0" to "255" for A – D PW208mNX: None	255.255.255.0	R/W	-	IPv4 Subnet mask
IPv4_DEFGATEWAY	PW208NX: AAA.BBB.CCC.DDD Allow "0" to "255" for A – D PW208mNX: None	0.0.0.0	R/W	-	IPv4 Default gateway
IPv4_DNSPrimaryIPAddress	PW208NX: AAA.BBB.CCC.DDD Allow "0" to "255" for A – D PW208mNX m: None	0.0.0.0	R/W	-	IPv4 DNS primary address
IPv4_DNSSecondaryIPAddress	PW208NX: AAA.BBB.CCC.DDD Allow "0" to "255" for A – D PW208mNX: None	0.0.0.0	R/W	-	IPv4 DNS secondary address
IPv6_ADDSET	PW208NX: "0": AUTO "1": DHCP "2": Manual Setting PW208mNX: None	0	R/W	-	IPv6 address setting
IPv6_ADDRESS	PW208NX: AAAA: BBBB: CCCC: DDDD: EEEE: FFFF: GGGG: HHHH Specified in the ASCII of 128bit A to H is "0" to "FFFF" A to H is Omissible. PW208mNX: None	0: 0: 0: 0: 0: 0: 0: 0	R/W	-	IPv6 address
IPv6_ROUTER	PW208NX: AAAA: BBBB: CCCC: DDDD: EEEE: FFFF: GGGG: HHHH Specified in the ASCII of 128bit A to H is "0" to "FFFF" A to H is Omissible. PW208mNX: None	0: 0: 0: 0: 0: 0: 0: 0	R/W	-	IPv6 Default Router
IPv6_PREFIX	PW208NX: 1 to 128 PW208mNX: None	64	R/W	-	IPv6 Subnet prefix
IPv6_DNSPrimaryIPAddress	PW208NX: AAAA: BBBB: CCCC: DDDD: EEEE: FFFF: GGGG: HHHH Specified in the ASCII of 128bit A to H is "0" to "FFFF" A to H is Omissible. PW208mNX: None	0: 0: 0: 0: 0: 0: 0: 0	R/W	-	IPv6 DNS primary address
KEEPALIVETIME	PW208NX: "30" to "300"(seconds) PW208mNX: None	180	R/W	o	Keep alive time

[LAN]

Name of Setting item	Setting value	Default Vale.	R/W	initial	Contents of Setting item
				IL	
KEEPAVIVECOUNT	PW208NX: "1" to "99"(times) PW208mNX: None	17	R/W	○	Keep alive count
SOCKET_CANCEL	PW208NX: "0": Normal mode "1": Compatible mode PW208mNX: None	0	R/W	○	Socket compatibility
PROTOCOL	"1": Status 4 (ENQ) "2": Status 3 "4": NONE	1	R/W	○	Communication protocol (For SBPL)
PORT1	PW208NX: "1" to "65535" PW208mNX: None	1024	R/W	○	Port 1
PORT2	PW208NX: "1" to "65535" PW208mNX: None	1025	R/W	○	Port 2 The number is set in priority order of Port 3>Port 2>Port 1
PORT3	PW208NX: "1" to "65535" PW208mNX: None	9100	R/W	○	Port 3 The number is set in priority order of Port 3>Port 2>Port 1
SNMP	PW208NX: "0": Disable "1": Enable PW208mNX: None	PW208NX: 1	R/W	○	SNMP settings
SNMP_R_VERSION	PW208NX: "0": 1 2c 3 "1": 1 2c "2": 3 "3": Disable PW208mNX: None	0	R/W	○	SNMP Version
SNMP_R_COMMUNITY_NAME	PW208NX: Max 32 digit character *Encrypted data PW208mNX: None	public (empty string to disable)	R/W	○	Read-only community name
SNMP_R_USERNAME	PW208NX: Max 32 digit character *Encrypted data PW208mNX: None	rouser (empty string to disable)	R/W	○	Read-only user name
SNMP_R_SECURITY	PW208NX: "0": none "1": Authentication "2": Privacy PW208mNX: None	none	R/W	○	Read-only security
SNMP_R_AUTHPROTOCOL	PW208NX: "0": MD5 "1": SHA PW208mNX: None	0	R/W	○	Read-only Authentication protocol
SNMP_R_AUTHPASSWORD	PW208NX: String of 8 to 32 digits *Encrypted data PW208mNX: None	mypassword	R/W	○	Read-only Authentication password
SNMP_R_PRIVPROTOCOL	PW208NX: "0": DES "1": AES PW208mNX: None	0	R/W	○	Read-only Encryption protocol

[LAN]

Name of Setting item	Setting value	Default Vale.	R/W	initial	Contents of Setting item
				IL	
SNMP_R_PRIVPASS	PW208NX: String of 8 to 32 digits *Encrypted data PW208mNX: None	mypassword	R/W	○	Read-only Encryption password
SNMP_RW_VERSION	PW208NX: "0": 1 2c 3 "1": 1 2c "2": 3 "3": Disable PW208mNX: None	0	R/W	○	SNMP Version
SNMP_RW_COMMUNITY_NAME	PW208NX: Max 32 digit character *Encrypted data PW208mNX: None	private (empty string to disable)	R/W	○	Read Write community name
SNMP_RW_USERNAME	PW208NX: Max 32 digit character *Encrypted data PW208mNX: None	rwuser (empty string to disable)	R/W	○	Read Write user name
SNMP_RW_SECURITY	PW208NX: "0": none "1": Authentication "2": Privacy PW208mNX: None	none	R/W	○	Read Write security
SNMP_RW_AUTHPROTOCOL	PW208NX: "0": MD5 "1": SHA PW208mNX: None	0	R/W	○	Read Write Authentication protocol
SNMP_RW_AUTHPASS	PW208NX: String of 8 to 32 digits *Encrypted data PW208mNX: None	mypassword	R/W	○	Read Write Authentication password
SNMP_RW_PRIVPROTOCOL	PW208NX: "0": DES "1": AES PW208mNX: None	DES	R/W	○	Read Write Encryption protocol
SNMP_RW_PRIVPASS	PW208NX: String of 8 to 32 digits *Encrypted data PW208mNX: None	mypassword	R/W	○	Read Write Encryption password
SNMP_TRAP	PW208NX: "0": Disable "1": Enable PW208mNX: None	0	R/W	○	Trap
SNMP_TRAP_VERSION	PW208NX: "0": SNMPv1 "1": SNMPv2c "2": SNMPv3 PW208mNX: None	0	R/W	○	Trap version
SNMP_TRAP_DESTINATIONS	PW208NX: "1": Destination1 "2": Destination2 "3": Destination3 PW208mNX: None	1	R/W	○	Trap Destinations

[LAN]

Name of Setting item	Setting value	Default Vale.	R/W	initial	Contents of Setting item
				IL	
SNMP_TRAP_IPVERSION	PW208NX: "4": IPv4 "6": IPv6 PW208mNX: None	4	R/W	○	Trap IP Version
SNMP_TRAP_DESTINATION1v4	PW208NX: AAA.BBB.CCC.DDD Allow "0" to "255" for A – D PW208mNX: None	0.0.0.0	R/W	○	IPv4 Trap Destination1
SNMP_TRAP_DESTINATION1v6	PW208NX: AAAA: BBBB: CCCC: DDDD: EEEE: FFFF: GGGG: HHHH Specified in the ASCII of 128bit A to H is "0" to "FFFF" A to H is Omissible. PW208mNX: None	0: 0: 0: 0: 0: 0: 0: 0	R/W	○	IPv6 Trap Destination1
SNMP_TRAP_DESTINATION2v4	PW208NX: AAA.BBB.CCC.DDD Allow "0" to "255" for A – D PW208mNX: None	0.0.0.0	R/W	○	IPv4 Trap Destination2
SNMP_TRAP_DESTINATION2v6	PW208NX: AAAA: BBBB: CCCC: DDDD: EEEE: FFFF: GGGG: HHHH Specified in the ASCII of 128bit A to H is "0" to "FFFF" A to H is Omissible. PW208mNX: None	0: 0: 0: 0: 0: 0: 0: 0	R/W	○	IPv6 Trap Destination2
SNMP_TRAP_DESTINATION3v4	PW208NX: AAA.BBB.CCC.DDD Allow "0" to "255" for A – D PW208mNX: None	0.0.0.0	R/W	○	IPv4 Trap Destination3
SNMP_TRAP_DESTINATION3v6	PW208NX: AAAA: BBBB: CCCC: DDDD: EEEE: FFFF: GGGG: HHHH Specified in the ASCII of 128bit A to H is "0" to "FFFF" A to H is Omissible. PW208mNX: None	0: 0: 0: 0: 0: 0: 0: 0	R/W	○	IPv6 Trap Destination3
SNMP_TRAP_COMMUNITY	PW208NX: Max 32 digit character * Encrypted data PW208mNX: None	trapcom	R/W	○	Trap community name
SNMP_TRAP_USER	PW208NX: Max 32 digit character * Encrypted data PW208mNX: None	trapuser	R/W	○	Trap user name
SNMP_TRAP_ENGINEID	PW208NX: Even number 10 to 64 digits PW208mNX: None	Number generated from Unique Code	R/W	○	Trap Engine ID
SNMP_TRAP_SECURITY	PW208NX: "0": none "1": Authentication "2": Privacy PW208mNX: None	none	R/W	○	Trap Security

[LAN]

Name of Setting item	Setting value	Default Vale.	R/W	initial	Contents of Setting item
				IL	
SNMP_TRAP_AUT HPCOL	PW208NX: "0": MD5 "1": SHA PW208mNX: None	0	R/W	○	Trap Authentication protocol
SNMP_TRAP_AUT HPASS	PW208NX: String of 8 to 32 digits * Encrypted data PW208mNX: None	mypassword	R/W	○	Trap Authentication password
SNMP_TRAP_PRI VPCOL	PW208NX: "0": DES "1": AES PW208mNX: None	DES	R/W	○	Trap Encryption protocol
SNMP_TRAP_PRI VPASS	PW208NX: String of 8 to 32 digits * Encrypted data PW208mNX: None	mypassword	R/W	○	Trap Encryption password
LPD	PW208NX: "0": Disable "1": Enable PW208mNX: None	1	R/W	○	LPD
FTP	PW208NX: "0": Disable "1": Enable PW208mNX: None	0	R/W	○	FTP
ACTIVE_NETWORK	PW208NX: "2": WLAN PW208mNX: None	-	R	-	LAN/WLAN Switching (Auto)

[USB]

Name of Setting item	Setting value	Default Value	R/W	initial	Contents of Setting item
				IU	
PROTOCOL	"0": Status4 "2": NONE	0	R/W	○	Communication protocol (for SBPL)

[WLAN] * PW208mNX: WLAN is not equipped.

Name of Setting item	Setting value	Default Value	R/W	initial	Contents of Setting item
				IW	
DHCPv4_WLAN	"0": Static "1": DHCP	1	R/W	○	DHCPv4 setting
IPv4_ADDRESS_WLAN	AAA.BBB.CCC.DDD Allow "0" to "255" for A - D	0.0.0.0	R/W	○	Ipv4 Address
IPv4_SUBNETMASK_WLAN	AAA.BBB.CCC.DDD Allow "0" to "255" for A - D	255.255.255.0	R/W	○	IPv4 Subnet mask
IPv4_DEFGATEWAY_WLAN	AAA.BBB.CCC.DDD Allow "0" to "255" for A - D	0.0.0.0	R/W	○	IPv4 Default gateway
IPv4_DNSPrimaryIPAddress_WLAN	AAA.BBB.CCC.DDD Allow "0" to "255" for A - D	0.0.0.0	R/W	○	IPv4 DNS primary address

[WLAN] * PW208mNX: WLAN is not equipped.

Name of Setting item	Setting value	Default Value	R/W	initial	Contents of Setting item
				IW	
IPv4_DNSSecondaryIPAddress_WLAN	AAA.BBB.CCC.DDD Allow "0" to "255" for A - D	0.0.0.0	R/W	○	IPv4 DNS secondary address
IPv6_ADDSET_WLAN	"0": AUTO "1": DHCP "2": Manual Setting "3": Disable	3	R/W	○	IPv6 address setting
IPv6_ADDRESS_WLAN	AAAA: BBBB: CCCC: DDDD: EEEE: FFFF: GGGG: HHHH Specified in the ASCII of 128bit A to H is "0" to "FFFF" A to H is Omissible.	0: 0: 0: 0: 0: 0: 0: 0	R/W	○	IPv6 address
IPv6_ROUTER_WLAN	AAAA: BBBB: CCCC: DDDD: EEEE: FFFF: GGGG: HHHH Specified in the ASCII of 128bit A to H is "0" to "FFFF" A to H is Omissible.	0: 0: 0: 0: 0: 0: 0: 0	R/W	○	IPv6 Default Router
IPv6_PREFIX_WLAN	1 to 128	64	R/W	○	IPv6 Subnet prefix
IPv6_DNSPrimaryIPAddress_WLAN	AAAA: BBBB: CCCC: DDDD: EEEE: FFFF: GGGG: HHHH Specified in the ASCII of 128bit A to H is "0" to "FFFF" A to H is Omissible.	0: 0: 0: 0: 0: 0: 0: 0	R/W	○	IPv6 DNS primary address
WLANMODE	"0": Infrastructure mode "1": Ad Hoc mode	1	R/W	○	Select WLAN Mode
ESSID	1 to 32 digit long character	SATO_PRINTER	R/W	○	SSID
HIDEESSID	"0": Disable "1": Enable	1	R/W	○	Hidden SSID
CHANNEL	"1" to "11" "1" to "13" *The range follows Region.	6	R/W	○	Channel number
WLANNETWORKSECINF	"0": None "1": WEP "2": WPA+WPA2 "3": WPA2 "4": Dynamic WEP	0	R/W	○	Infrastructure mode Network security
WLANNETWORKSECAD	"0": None "1": WEP	0	R/W	○	Ad Hoc mode Network security
WEPAUTH	"0": Open System "1": Shared Key	0	R/W	○	WEP key
WEPKEY1	5 or 13 digit character 10 or 26 digit hexadecimal * Encrypted data	String of empty	W	○	WEP key 1
WEPKEY2	5 or 13 digit character 10 or 26 digit hexadecimal * Encrypted data	String of empty	W	○	WEP key 2
WEPKEY3	5 or 13 digit character 10 or 26 digit hexadecimal * Encrypted data	String of empty	W	○	WEP key 3
WEPKEY4	5 or 13 digit character 10 or 26 digit hexadecimal * Encrypted data	String of empty	W	○	WEP key 4
WEPKEYINDEX	"1" to "4"	1	R/W	○	WEP key index

[WLAN] * PW208mNX: WLAN is not equipped.

Name of Setting item	Setting value	Default Value	R/W	initial	Contents of Setting item
				IW	
WPAAUTH	"0": Personal (PSK), "1": Enterprise (802.1x) "2": CCKM	0	R/W	○	WPA authentication
PSK	8-63 ASCII or 64 HEX digits * Encrypted data	String of empty	W	○	PSK *WPA Auth is PSK
EAPMODE	"0": FAST "1": LEAP "2": PEAP "3": TLS "4": TTLS	0	R/W	○	EAP Mode *WPA Auth is not PSK
INNER_FAST	"0": MSCHAPv2 "1": GTC "2": TLS	"0": MSCHAPv2	R/W	○	Inner Method if EAP Mode=FAST
INNER_PEAP	"0": MSCHAPv2 "1": GTC "2": MD5 "3": OTP "4": TLS	"0": MSCHAPv2	R/W	○	Inner Method if EAP Mode=PEAP
INNER_TTLS	"0": MSCHAPv2 "1": MSCHAP "2": CHAP "3": PAP "4": EAP-GTC "5": EAP-MD5 "6": EAP-MSCHAPv2 "7": EAP-OTP "8": EAP-TLS	"0": MSCHAPv2	R/W	○	Inner Method if EAP Mode=TTLS
EAP_USERNAME	0-63 digit long characters	NULL	R/W	○	EAP authentication user name
EAP_PASSWORD	0-32 digit long characters * Encrypted data	String of empty	W	○	EAP authentication password
EAP_ANON	0-63 digit long characters	NULL	R/W	○	Anon. Outer ID If EAP Mode=FASE,PEAP,TTLS
EAP_VERIFY	"0": Disable "1": Enable	1	R/W	○	Verify Server Cert. Not for LEAP
EAP_PRIVATEKEY	0-64 digit long characters * Encrypted data	String of empty	W	○	Private Key P/W
EAP_AUTO_PAC	"0": Disable "1": Enable	0	R/W	○	PAC Auto Provisioning If EAP Mode=FAST
EAP_PAC_PASS	0-64bytes * Encrypted data	String of empty	W	○	PAC Password If EAP=FAST & Auto prov.=off
SignalLevel1	-85 dBm	-	R	-	Threshold for electrical field strength 1
SignalLevel2	-74 dBm	-	R	-	Threshold for electrical field strength 2
SignalLevel3	-64 dBm	-	R	-	Threshold for electrical field strength 3
FWversion	x.x.x.	-	R	-	Firmware version for WLAN module
MACADDRESS	"AA: BB: CC: DD: EE: FF"	-	R	-	MAC address
WIFI_DEVICE_NAME	1-32 digit long characters	SATO_PRINTER	R/W	○	Wi-Fi Direct Device Name

[BLUETOOTH]

Name of Setting item	Setting value	Default Value	R/W	initial	Contents of Setting item
				IB	
BLUETOOTH	"0": Disable "1": Enable	1	R/W	○	Bluetooth
PROTOCOL	"0": status 3 "1": status 4 "2": NONE	1	R/W	○	Communication protocol (for SBPL)
BLUELEVEL	"0": No authentication "1": Auth. level 2-1 "2": Auth. level 2-2 "3": Auth. level 3 "4": Auth. level 4	0	R/W	○	Authentication level
PINCODE	0-16 digit characters (except "") *Encrypted data	0000	R/W	○	PIN code
DEVICENAME	0-53 digit characters	SATO PRINTER _ xxxxxxxxxxxx	R/W	○	Device name (xxxxxxxxxxxx is BD address)
ISI	"0", "12" to "1000" (hexadecimal)	800	R/W	○	ISI value will be set to Bluetooth module after deducting 1 from the value when odd number is set with ISI
ISW	"0", "11" to "1000" (hexadecimal)	12	R/W	○	ISW Set $ISI \geq ISW$
PSI	"12" to "1000" (hexadecimal)	800	R/W	○	PSI value will be set to Bluetooth module after deducting 1 from the value when odd number is set with PSI
PSW	"11" to "1000" (hexadecimal)	12	R/W	○	PSW Set $PSI \geq PSW$
BLUEADDRESS	"aabbccddeeff"	-	R	-	BD address
BLUEVERSION	"spp3_vX.YY"	-	R	-	Bluetooth firmware version
CRC	"0": Disabled "1": Enabled	0	R/W	○	CRC mode
PAIRING1	"0": Do not remove "1": Remove	0	W	-	Remove pairing information 1 or not
PAIRING2	"0": Do not remove "1": Remove	0	W	-	Remove pairing information 2 or not
PAIRING3	"0": Do not remove "1": Remove	0	W	-	Remove pairing information 3 or not
PAIRING4	"0": Do not remove "1": Remove	0	W	-	Remove pairing information 4 or not
PAIRING5	"0": Do not remove "1": Remove	0	W	-	Remove pairing information 5 or not
PAIRING6	"0": Do not remove "1": Remove	0	W	-	Remove pairing information 6 or not
PAIRING7	"0": Do not remove "1": Remove	0	W	-	Remove pairing information 7 or not
PAIRING8	"0": Do not remove "1": Remove	0	W	-	Remove pairing information 8 or not
PAIRING9	"0": Do not remove "1": Remove	0	W	-	Remove pairing information 9 or not
PAIRING10	"0": Do not remove "1": Remove	0	W	-	Remove pairing information 10 or not
SPP_TIME	"0" to "10" (Unit: seconds)	0	R/W	○	Time to timeout for disconnection (SPP layer)
LMP_TIME	"0" to "999" (Unit: 0.1 seconds)	100	R/W	○	Time to timeout for disconnection (LMP layer)

[BLUETOOTH]

Name of Setting item	Setting value	Default Value	R/W	initial	Contents of Setting item
				IB	
PAIRING_INFO1	"aabbccddeeff" (BD address only)	-	R	-	Paring information 1
PAIRING_INFO2	"aabbccddeeff" (BD address only)	-	R	-	Paring information 2
PAIRING_INFO3	"aabbccddeeff" (BD address only)	-	R	-	Paring information 3
PAIRING_INFO4	"aabbccddeeff" (BD address only)	-	R	-	Paring information 4
PAIRING_INFO5	"aabbccddeeff" (BD address only)	-	R	-	Paring information 5
PAIRING_INFO6	"aabbccddeeff" (BD address only)	-	R	-	Paring information 6
PAIRING_INFO7	"aabbccddeeff" (BD address only)	-	R	-	Paring information 7
PAIRING_INFO8	"aabbccddeeff" (BD address only)	-	R	-	Paring information 8
PAIRING_INFO9	"aabbccddeeff" (BD address only)	-	R	-	Paring information 9
PAIRING_INFO10	"aabbccddeeff" (BD address only)	-	R	-	Paring information 10
IOS_RECONNECT	0: Disable 1: Manual	0	R/W	○	iOS Re-Connect
IAP_FUNCTION	0: CP Chip not implemented 1: CP Chip abnormal 2: CP Chip normal	-	R	-	iAP function
GIVE_BDADDRESS	0: Disable 1: Enable	1	R/W	○	Set BD address (Enable to add BD address to the device name) * Only PW208NX/PW208mNX
IOCAPABILITY_C OMPATI	0: Disable 1: Enable	0	R/W	○	Compatibility with the Bluetooth IO capability of PW208 * Only PW208NX/PW208mNX

Name of Setting item	Setting value	Default Value		R/W	initial	Contents of Setting item
					SB	
ZEROSLASH	"0": Disable "1": Enable	1		R/W	○	Zero slash <LH>, <LD>
SHOTAI	"1": Gothic "0": Mincho	1		R/W	○	Type face <KG>, <KM>
PROPORTIONAL	"0": Fixed pitch "1": Proportional pitch	1		R/W	○	Proportional pitch <PS>, <PR>
STDCODE	"0": Standard code "1": Non-standard code	0		R/W	○	Protocol code
CMDERR	"0": Disable "1": Enable	0		R/W	○	Command error
STXCODE	"0" to "255"	standard 2(0x02)	non-standard 123(0x7B)	R/W	○	STX <LD>
ETXCODE	"0" to "255"	3(0x03)	125(0x7D)	R/W	○	ETX <LD>
ESCCODE	"0" to "255"	27(0x1B)	94(0x5E)	R/W	○	ESC <LD>
ENQCODE	"0" to "255"	5(0x05)	64(0x40)	R/W	○	ENQ <LD>
CANCODE	"0" to "255"	24(0x18)	33(0x21)	R/W	○	CAN <LD>
NULLCODE	"0" to "255"	0(0x00)	126(0x7E)	R/W	○	NULL <LD>
OFFLINECODE	"0" to "255"	64(0x40)	93(0x5D)	R/W	○	OFFLINE <LD>
EUROCODE	"0" to "255"	213(0xD5)	213(0xD5)	R/W	○	EURO <LD>
KANJI	"0": JIS code "1": SJIS code "2": Unicode (UTF16) "3": GB18030 "4": BIG5 "5": KSC5601 (EUC-KR) "6": Unicode (UTF8)	3		R/W	○	Kanji code <KC> "6": Unicode(UTF8) is only applicable to PW208NX/PW208mNX.

[SBPL]

Name of Setting item	Setting value	Default Value	R/W	initial	Contents of Setting item
				SB	
KNJ_MODE	"0": JIS X0208 compatible "1": JIS X0208 "2": JIS X0213 "3": GB18030 "4": BIG5 "5": KSC5601 (EUC-KR) "6": Unicode (UTF8)	3	R/W	○	Kanji mode
CODE_PAGE	"0": UTF8 "1": CP858 "2": ISO8859-1 "3": ISO8859-2 "4": ISO8859-9 "5": CP737 "6": CP855 "7": CP850 "8": CP852 "9": CP857 "10": CP866 "11": CP1250 "12": CP1251 "13": CP1252 "14": CP1253 "15": CP1254 "16": CP1257 "17": CP869 "18": JIS X0201	1	R/W	○	Code page
COMP_PT_K3	"0": Disable "1": Enable	0	R/W	○	PT /MB Compatible (K3)
COMP_PT_PG	"0": Disable "1": Enable	0	R/W	○	PT /MB Compatible (PG)
COMP_PT_ENQ	"0": Disable "1": Enable	0	R/W	○	PT/MB Compatible (Status)
Orientation	"0": Portrait "1": Landscape "2": Inv. Portrait "3": Inv. Landscape	0	R/W	○	Orientation
CODE128(C)_Zero_Fil l	"0" : Disable "1" : Enable	0	R/W	○	Compatible Code128
CALL_FONTLOGO	"0" : Disable "1" : Enable	0	R/W	○	Character code compatible at Download Font / Log call
QTY_Update_Timing	"0" : Disable "1" : Enable	0	R/W	○	QTY_Update_Timing
COMP_PT_PITCH	"0" : Disable "1" : Enable	0	R/W	○	PT200e/MB200i Compatible pitch command

[SZPL] section

Name of Setting item	Setting value	Default Value	R/W	initial	Contents of Setting item
				SZ	
PITCH_OFFSET	"-120" to "120" (dot)	0	R/W	○	Pitch offset at top of label
SHIFT_OFFSET	609 dpi: "-2496" to "2496" (dot) 305 dpi: "-1248" to "1248" (dot) 205 dpi: "-832" to "832" (dot)	0	R/W	○	Label shift offset
PROTOCOL	"0": None "1": ACK/NAK	0	R/W	○	Protocol
CMD_HEAD	"0" to "255"	94	R/W	○	Command head
CTR_HEAD	"0" to "255"	126	R/W	○	Control head
DELIMITER	"0" to "255"	44	R/W	○	Delimiter
DATE_FORM	"0": Normal "1": MM/DD/YY (24 hours) "2": MM/DD/YY (12 hours) "3": DD/MM/YY (24 hours) "4": DD/MM/YY (12 ours)	0	R/W	○	Date and time format
DEF_FONT	"0": none "1": SATO Hebe Sans "2": SATO Hebe Sans Arabic "3": SATO Hebe Sans Thai "4": SATO Hebe Sans Hindi "5": SATO Gothic T Chinese "6": SATO Gothic Japanese "7": SATO Gothic S Chinese "8": SATO Gothic Korean "9": SATO Silver Serif "10": SATO Mincho T Chinese "11": SATO Mincho Japanese "12": SATO Mincho S Chinese "13": SATO Mincho Korean "14": SATO Roman Arabic "15": SATO Hebe Sans Hebrew	0	R/W	○	Default font

[NFC] section * PW208NX/208mNX only

Name of Setting item	Setting value	Default Value	R/W	initial	Contents of Setting item
				IN	
IF	"0": Disable "1": Enable	1	R/W	○	NFC communication availability
ISINSTALLED	"0": not checked "1": installed "2": not installed	0	R	○	Whether NFC module is installed
MODULE_INFO	"AAAAAAAAAAAAA,BBCCDD EE" AAAAA...A : Serial number BBCCDDEE : Capability Container BB : E1 - NFC Forum CC : version number ex)11 indicates 1.1 DD :memory size of the data area. ex) EA x 8 = 1876 bytes EE : read and write ccess capability of the data area ex)00 indicates r/w ok	-	R	-	information of the installed NFC module
CONFIRM	"0": none "1": confirm "2": password	0	R/W	○	Whether display confirmation screen when install setting from NFC

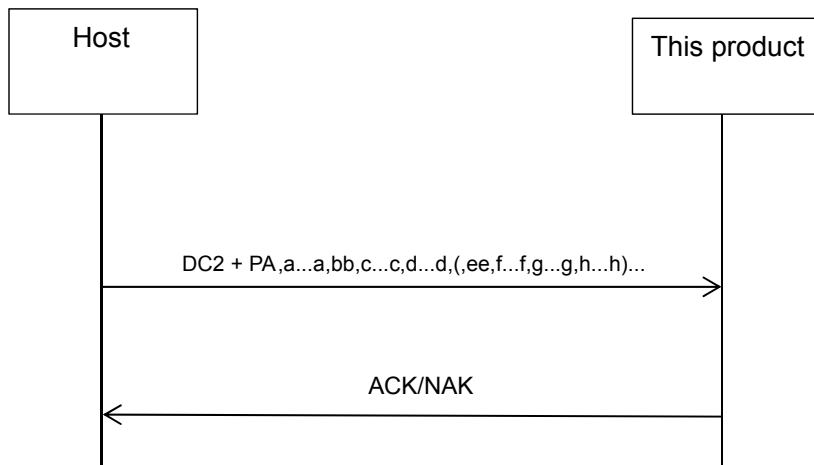

[DC2+PB] Printer setting information acquisition

Command	DC2	PB	Parameter
Hexadecimal code	<12> ₁₆	<50> ₁₆ <42> ₁₆	(,aa(,b...b)) + EOT(04h)
Initial Value	None		

Valid range and term of command	When turning off the power	-
	Valid range	-
	Printer operation in progress	The command can be received even during the printer operation.
	When acquiring label sensor information	Commands are not accepted while acquiring sensor information. ([NAK] reply)
	Error	The command can be received even if an error is occurring.

[Function]

This command is used to acquire the printer information.

[Format]

[DC2]PB(,aa(,b...b))[EOT]

[Parameters]

Symbol	Parameter name	Valid range	Note
a	Identifier	Refer to [Identifier] below	When omitted, all items will be returned.
b	Setting Item name	Refer to [DC2 + PA] command	Acquire up to [EOT]

[Return data format (normal)]

[STX]a...a,bb,c...c,d...d(,ee,f...f,g...g)...[ETX]

[Return data]

Symbol	Parameter name	Valid range
a	Total number of data byte * This is the total number of bytes after parameter b. The delimiting comma between parameters a and b, and the ETX are not included.	Data size from the first identifier until before [ETX]
b(e)	Identifier	Refer to [Identifier] below.
c(f)	Setting information data size * Number of bytes of the section unit after parameter d. The delimiting comma between sections is not included.	Size of the corresponding setting information data
d(g)	Setting information data * Text format	Refer to "Setup information data" below.

[Identifier]**Valid range**

CA: Common settings

CB: Notification functionality

IL: LAN settings

IU: USB settings

IW: WLAN settings

IB: Bluetooth settings

IN: NFC settings * PW208NX/PW208mNX only

SB: SBPL settings

SZ: SZPL settings

SP: SPOS settings (reserve)

SC: SCPL settings (reserve) * PW208NX/PW208mNX only

[Setting information data format]

"Setting item name" + ":" + "Setting data" + "Line feed (0DH, 0AH)"

h...h:i...i[CR][LF](j...j:k...k[CR][LF])...

[Setting information data]

Symbol	Parameter name	Valid range
h(j...)	Setting Item name	Refer to the list of setting items of [DC2+PA].
i(k...)	Setting data	Refer to the list of setting items of [DC2+PA].

Data Example)

CA,12345,SPEED:4

LEVEL:5

CONCENTRATION:A

:

[Return data format (when a command error occurs)][NAK]<15>₁₆**[Exception processing]**

Parameter name	Exception condition	
	A value outside the range is specified	The specified size and received size are different
Identifier	Command error	Invalid receive data

Terminology	Description
Command error	The data received after a command error is determined is not considered as a parameter of this command.

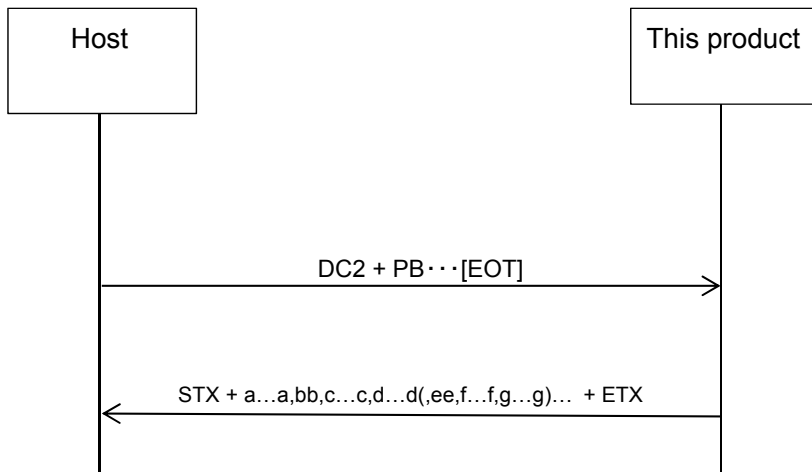

[Note]

- When identifiers are omitted, all data will be returned.
- When setting item names are specified, setting information of the item which was set will be returned.

[DC2+PC] Printer device information acquisition

Command	DC2	PC	Parameter
Hexadecimal code	<12> ₁₆	<50> ₁₆ <43> ₁₆	None
Initial Value	None		

Valid range and term of command	When turning off the power	-
	Valid range	-
	Printer operation in progress	The command can be received even during the printer operation.
	When acquiring label sensor information	Commands are not accepted while acquiring sensor information. ([NAK] reply)
	Error	The command can be received even if an error is occurring.

[Function]

This command returns the printer device information.

[Format]

DC2 (12H) + PC

[Return data format (normal)]

[STX]a...a,b...b:c...c[CR][LF](d...d:e...e[CR][LF]) ... [ETX]

[Return data]

Symbol	Parameter name	Valid range
a	Total number of data byte * This is the total number of bytes after parameter b. The delimiting comma between parameters a and b, and the ETX are not included.	Data size from the first device information name up to before [ETX]
b(d)	Device information name * Text format	Refer to the printer device information list.
c(e)	Device information data * Text format	Refer to the printer device information list.

Data Example)

[STX]12345,MODEL: Model name[CR][LF]FW Ver:1.0.0[CR][LF]...[CR][LF] [ETX]

[Printer device information list]

No.	Description	Device information name	Device information data
1	Model name	MODEL	M...M M: Model name
2	Kernel version	KERNEL Ver	R...R R: OS release number

No.	Description	Device information name	Device information data
3	Main firmware version	MAIN FW Ver	V...V V: Version
4	Main firmware Creation date	MAIN FW Date	YYYYMMDD_HHMMSS TTT T: Time zone
5	Printer module Boot firmware Version	MODULE BOOT FW Ver	P...P.boot-V.V.V-S...S P: Platform name V: Version S: Release = Release version Alpha/Beta = Test version xxxuser = Custom version urgent = Urgent version
6	Printer module Boot firmware Creation date	MODULE BOOT FW Date	YY.MM.DD
7	Printer module Boot firmware Check sum	MODULE BOOT FW CHECKSUM	CCCC C: Check sum
8	Printer module Main firmware Version	MODULE MAIN FW Ver	P...P.main-V.V.V-S...S P: Platform name V: Version S: Release = Release version Alpha/Beta = Test version xxxuser = Custom version urgent = Urgent version
9	Printer module Main firmware Creation date	MODULE MAIN FW Date	YY.MM.DD
10	Printer module Main firmware Check sum	MODULE MAIN FW CHECKSUM	CCCC C: Check sum
11	PLD version of CONT board	CONT PLD Ver	VV V: Version
12	PLD version and FPGA version of interface board	INTF PLD/FPGA Ver	V ₁ V ₁ /V ₂ V ₂ V ₁ : PLD Version V ₂ : FPGA Version
13	Sensor module Boot firmware Version	SENSOR BOOT FW Ver	P...P.main-V.V.V-S...S P: Platform name V: Version S: Release = Release version Alpha/Beta = Test version xxxuser = Custom version urgent = Urgent version * Return PW208NX/PW208mNX only
14	Sensor module Boot firmware Creation date	SENSOR BOOT FW Date	YY.MM.DD * Return PW208NX/PW208mNX only
15	Sensor module Boot firmware Checksum	SENSOR BOOT FW CHECKSUM	CCCC C: Check sum
16	Sensor module Main firmware Version	SENSOR MAIN FW Ver	P...P.main-V.V.V-S...S

No.	Description	Device information name	Device information data
			P: Platform name V: Version S: Release = Release version Alpha/Beta = Test version xxxuser = Custom version urgent = Urgent version * Return PW208NX/PW208mNX only
17	Sensor module Main firmware Creation date	SENSOR MAIN FW Date	YY.MM.DD * Return PW208NX/PW208mNX only
18	Sensor module Main firmware Checksum	SENSOR MAIN FW CHECKSUM	CCCC C: Check sum * Return PW208NX/PW208mNX only
19	LAN MAC Address	LAN MAC	XX:XX:XX:XX:XX:XX X: Alphanumeric
20	WLAN MAC Address	WLAN MAC	XX:XX:XX:XX:XX:XX X: Alphanumeric
21	BD Address	BD	xxxxxxxxxxxx X: Alphanumeric
22	Head counter 1	Head Count1	Numeric value (unit: mm)
23	Head counter 2	Head Count2	Numeric value (unit: mm)
24	Head counter 3	Head Count3	Numeric value (unit: mm)
25	Life counter	Life Count	Numeric value (unit: mm)
26	Free space size in user area	MEM_FROM	Numeric value (unit: byte)
27	USB memory available size (Printer front port connection)	MEM_USB1	Numeric value (unit: byte)
28	USB memory available size (Printer rear port connection)	MEM_USB2	Numeric value (unit: byte)
29	SBPL form overlay SLOT1 Number of registered counts, number of registered bytes	SBPL_FOL_SLOT1	XXXX,YYYYYYYYYYY X: Registration count Y: Number of registered bytes
30	SBPL form overlay SLOT1 Registration number	SBPL_FOL_SLOT1_No	XXX (,XXX,XXX...) X: Registration No., * Repeated as many times as the registration numbers * If the registration count is zero, the value is ignored.
31	SBPL format SLOT1 Number of registered counts, number of registered bytes	SBPL_FMT_SLOT1	XXXX,YYYYYYYYYYY X: Registration count Y: Number of registered bytes
32	SBPL format SLOT1 Registration number	SBPL_FMT_SLOT1_No	XXX (,XXX,XXX...)

No.	Description	Device information name	Device information data
			X: Registration No., * Repeated as many times as the registration numbers * If the registration count is zero, the value is ignored.
33	SBPL graphic SLOT1 Number of registered counts, number of registered bytes	SBPL_GRA_SLOT1	XXXX,YYYYYYYYYYY X: Registration count Y: Number of registered bytes
34	SBPL graphic SLOT1 Registration number	SBPL_GRA_SLOT1_No	XXX (,XXX,XXX···) X: Registration No., * Repeated as many times as the registration numbers * If the registration count is zero, the value is ignored.
35	SBPL BMP file SLOT1 Number of registered counts, number of registered bytes	SBPL_BMP_SLOT1	XXXX,YYYYYYYYYYY X: Registration count Y: Number of registered bytes
36	SBPL BMP file SLOT1 Registration number	SBPL_BMP_SLOT1_No	XXX (,XXX,XXX···) X: Registration No., * Repeated as many times as the registration numbers * If the registration count is zero, the value is ignored.
37	SBPL PCX file SLOT1 Number of registered counts, number of registered bytes	SBPL_PCX_SLOT1	XXXX,YYYYYYYYYYY X: Registration count Y: Number of registered bytes
38	SBPL PCX file SLOT1 Registration number	SBPL_PCX_SLOT1_No	XXX (,XXX,XXX···) X: Registration No., * Repeated as many times as the registration numbers * If the registration count is zero, the value is ignored.
39	SBPL external character SLOT1 Number of registered counts, number of registered bytes	SBPL_EXC_SLOT1	XXXX,YYYYYYYYYYY X: Registration count Y: Number of registered bytes
40	SBPL external character SLOT1 Registration number	SBPL_EXC_SLOT1_No	XXX (,XXX,XXX···) X: Registration No., * Repeated as many times as the registration numbers * If the registration count is zero, the value is ignored.
41	SBPL TrueType font SLOT1 Number of registered counts, number of registered bytes	SBPL_TTF_SLOT1	XXXX,YYYYYYYYYYY X: Registration count Y: Number of registered bytes
42	SBPL TrueType font SLOT1 Registration number	SBPL_TTF_SLOT1_No	XXX (,XXX,XXX···) X: Registration No., * Repeated as many times as the registration numbers * If the registration count is zero, the value is ignored.

No.	Description	Device information name	Device information data
43	SBPL form overlay SLOT2 Number of registered counts, number of registered bytes	SBPL_FOL_SLOT2	XXXX,YYYYYYYYYYY X: Registration count Y: Number of registered bytes
44	SBPL form overlay SLOT2 Registration number	SBPL_FOL_SLOT2_No	XXX (,XXX,XXX···) X: Registration No., * Repeated as many times as the registration numbers * If the registration count is zero, the value is ignored.
45	SBPL format SLOT2 Number of registered counts, number of registered bytes	SBPL_FMT_SLOT2	XXXX,YYYYYYYYYYY X: Registration count Y: Number of registered bytes
46	SBPL format SLOT2 Registration number	SBPL_FMT_SLOT2_No	XXX (,XXX,XXX···) X: Registration No., * Repeated as many times as the registration numbers * If the registration count is zero, the value is ignored.
47	SBPL graphic SLOT2 Number of registered counts, number of registered bytes	SBPL_GRA_SLOT2	XXXX,YYYYYYYYYYY X: Registration count Y: Number of registered bytes
48	SBPL graphic SLOT2 Registration number	SBPL_GRA_SLOT2_No	XXX (,XXX,XXX···) X: Registration No., * Repeated as many times as the registration numbers * If the registration count is zero, the value is ignored.
49	SBPL BMP file SLOT2 Number of registered counts, number of registered bytes	SBPL_BMP_SLOT2	XXXX,YYYYYYYYYYY X: Registration count Y: Number of registered bytes
50	SBPL BMP file SLOT2 Registration number	SBPL_BMP_SLOT2_No	XXX (,XXX,XXX···) X: Registration No., * Repeated as many times as the registration numbers * If the registration count is zero, the value is ignored.
51	SBPL PCX file SLOT2 Number of registered counts, number of registered bytes	SBPL_PCX_SLOT2	XXXX,YYYYYYYYYYY X: Registration count Y: Number of registered bytes
52	SBPL PCX file SLOT2 Registration number	SBPL_PCX_SLOT2_No	XXX (,XXX,XXX···) X: Registration No., * Repeated as many times as the registration numbers * If the registration count is zero, the value is ignored.
53	SBPL external character SLOT2 Number of registered counts, number of registered bytes	SBPL_EXC_SLOT2	XXXX,YYYYYYYYYYY X: Registration count Y: Number of registered bytes

No.	Description	Device information name	Device information data
54	SBPL external character SLOT2 Registration number	SBPL_EXC_SLOT2_No	XXX (,XXX,XXX···) X: Registration No., * Repeated as many times as the registration numbers * If the registration count is zero, the value is ignored.
55	SBPL TrueType font SLOT2 Number of registered counts, number of registered bytes	SBPL_TTF_SLOT2	XXXX,YYYYYYYYYY X: Registration count Y: Number of registered bytes
56	SBPL TrueType font SLOT2 Registration number	SBPL_TTF_SLOT2_No	XXX (,XXX,XXX···) X: Registration No., * Repeated as many times as the registration numbers * If the registration count is zero, the value is ignored.
57	Remaining amount of battery	BATT_REMAIN	Specify numeric value (Unit: %)
58	Battery recycle count	BATT_CYCLE_CNT	Specify numeric value (Unit: times)
59	Status of battery	BATT_HEALTH	0: OK / 1: Exchange / 2: Deteriorated
60	Status of charging (Battery icon)	BATT_CHARGE_STAT	1: AC adapter is not connected (Not charging (Charging is stopped after full charge or by error)) 2: Normal charge 3: Eco-friendly charge 4: Waiting for charging
61	Printer Serial	PR_SN	XXXXXXXX X: alphanumeric

[Precautions during use]

- The printer device information update cycle must be five seconds or longer. When sending this command in continuation, be sure to set an interval of five seconds or more.
- When a USB memory is used, only the available space of the memory connected first is returned even when a connection is established via the HUB.
- It takes more than one second to create the return data immediately after the startup in order to obtain the checksum of the module.
- It takes more time to create the return data when there are a lot of registrations by SBPL command. (It takes approx. 1.5 seconds to register 10,000 data.)

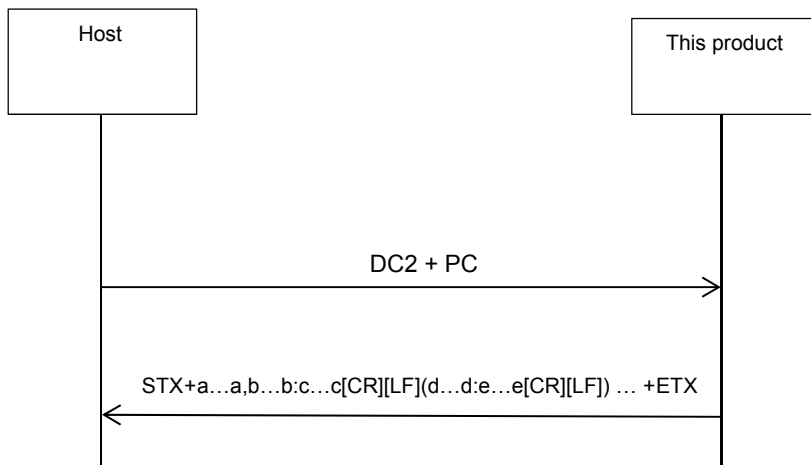

[DC2+PD] Each sensor information acquisition

Command	DC2	PD	Parameter
Hexadecimal code	<12> ₁₆	<50> ₁₆ <44> ₁₆	None
Initial Value	None		

Valid range and term of command	When turning off the power	-
	Valid range	-
	Printer operation in progress	The command can be received even during the printer operation.
	When acquiring label sensor information	Commands are not accepted while acquiring sensor information. ([NAK] reply)
	Error	The command can be received even if an error is occurring.

[Function]

This command is used to acquire the information of each sensor. The sensor information corresponds to the information immediately after the reception of the command.

[Format]

DC2 (12H) + PD

[Return data format (normal)]

[STX]a...a,b...b:c...c,(d...d:e...e) ... [ETX]

Symbol	Parameter name	Valid range
a	Total number of data byte * This is the total number of bytes after parameter b. The delimiting comma between parameters a and b, and the ETX are not included.	Data size from the first identifier until before [ETX]
b(d)	Sensor information name * Text format	Refer to the sensor information data list.
c(e)	Sensor information data * Text format	Refer to the sensor information data list.

Data Example)

[STX]xx,IM:0.2/SL1.5,GAP:0.9/SL1.0...[ETX]

[Return data format (when a command error occurs)]

[NAK]<15>₁₆

[Sensor information data list]

No.	Sensor information name	Description	Sensor information data
1	IM	I-Mark sensor	X.X/SLY.Y X.X = 0.0 to 3.3 : Sensor level Y.Y = 0.0 to 3.3 : Slice level
2	GAP	Gap sensor	X.X/SLY.Y X.X = 0.0 to 3.3 : Sensor level Y.Y = 0.0 to 3.3 : Slice level
3	PEEL	Dispense sensor	X.X/Y X.X = 0.0 to 3.3 : Sensor level Y = 0: Without label, 1: With label
4	LINERLESS	Linerless sensor	X.X/Y X.X = 0.0 to 3.3 : Sensor level Y = 0: Without label, 1: With label
5	HEAD OPEN	Head Open	0: Close, 1: Open
6	HEAD TEMP	Head thermistor	-XX to XX: Thermistor temperature
7	MOTOR TEMP	Motor thermistor	-XX to XX: Thermistor temperature
8	BOARD TEMP	Board thermistor	-XX to XX: Thermistor temperature
9	BATTERY TEMP	Battery thermistor	-XX to XX: Thermistor temperature
10	SENSOR HIGH	Value of High of active sensors	X.X = 0.0 to 3.3 : Sensor level
11	SENSOR LOW	Value of Low of active sensors	X.X = 0.0 to 3.3 : Sensor level

[Note]

- When sending this command in continuation, be sure to set a fixed interval (100 msec or more).
- If the sensor information acquisition processing for each sensor does not finish within 100 msec, a timeout is thought to have occurred, and [NAK] is returned. A timeout may occur during the printer operation.
- SENSOR HIGH, SENSOR LOW is the value of the last label that passed through the sensor. Therefore it may sometimes be different from test printing results (the value measured with the label before the printing label).
- If the sensor type is sensor disabled, the SENSOR HIGH, the SENSOR LOW returns 0.0.

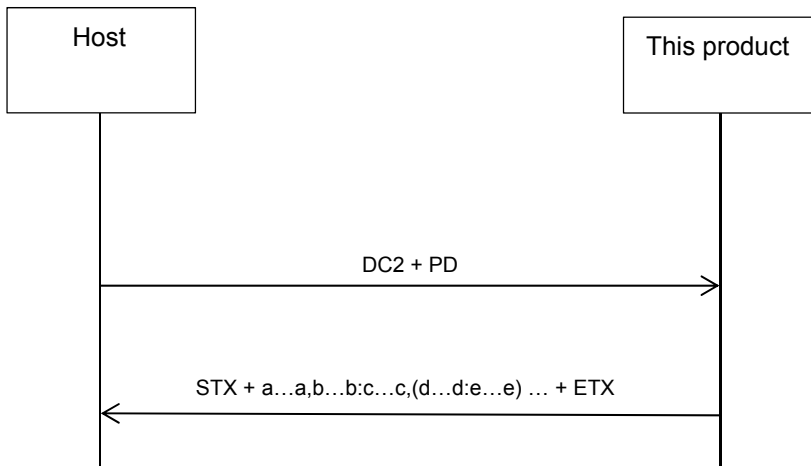

[DC2+PG] Printer status information acquisition

Command	DC2	PG	Parameter
Hexadecimal code	<12> ₁₆	<50> ₁₆ <47> ₁₆	None
Initial Value	None		

Valid range and term of command	When turning off the power	-
	Valid range	-
	Printer operation in progress	The command can be received even during the printer operation.
	When acquiring label sensor information	Commands are not accepted while acquiring sensor information. ([NAK] reply)
	Error	The command can be received even if an error is occurring.

[Function]

This command returns the printer status.

[Format]

DC2 (12H) + PG

[Return data format (normal)]

[STX]a...a,b...bc,d...de,...[ETX] * There is no ", (comma)" before ETX

Symbol	Parameter name	Valid range
a	Total number of data byte * This is the total number of bytes after parameter b. The delimiting comma between parameters a and b, and the ETX are not included.	Data size from the first identifier until before [ETX]
b(d)	Printer status information name * Text format	Refer to the printer status information data list.
c(e)	Printer status information data * Text format	Refer to the printer status information data list.

Data Example)

[STX]32,PS0,RS0,RE0,PE0,EN00,BT0,Q000000[ETX]

[Printer status information data list]

No.	Description	Printer status information name	Printer status information data
1	Printer status	PS	0: Standby (waiting for receiving data) 1: Waiting for dispensing 2: Analyzing 3: Printing 4: Offline 5: Error

No.	Description	Printer status information name	Printer status information data
2	Receive buffer status	RS	0: Buffer available 1: Buffer near full 2: Buffer full
3	Ribbon status * Monitoring can be performed during printing and feeding. The correct value cannot be acquired when the operation has stopped.	RE	0: Ribbon present 1: Ribbon near end 2: No ribbon 3: Direct thermal model
4	Media status * Monitoring can be performed during printing and feeding. The correct value cannot be acquired when the operation has stopped.	PE	0: Media present (including during startup) 1: Label near end 2: No media
5	Error No. *1	EN	00: Online *Not an error. Return is performed 01: Offline *Not an error. Return is performed 02: Machine error 03: Memory error 04: Program error 05: Setting information error (FLASH-ROM error) 06: Setting information error (EE-PROM error) 07: Download error 08: Parity error 09: Over run 10: Framing error 11: LAN timeout error 12: Buffer over 13: Head open 14: Paper end 15: Media error 16: Sensor error 17: Printhead error 18: Cover open error 19: Cutter error 20: Cutter sensor error 21: Stacker full error 22: Command error 23: Sensor error at Power-On 24: Interface card error 25: Rewinder error 26: Other error 27: Head density error 28: Kanji data error 30: Item No error

No.	Description	Printer status information name	Printer status information data
			31: BCC error 32: Cutter cover open error 33: Communication timeout error 34: Lid latch open error 35: Head lift error 36: Head overheat error 37: SNTP time correction error 38: CRC error 39: Cutter motor error 40: Scanner reading error 41: Scanner checking error 42: Scanner connection error 43: Bluetooth Module error 44: EAP authentication error (EAP failed) 45: EAP authentication error (Timeout) 46: Battery error 47: Low Battery error 48: Low Battery error (Charging) 49: Battery not installed error 50: Battery temperature error 51: Battery deterioration error 52: Motor temperature error 53: Inside chassis temperature error 54: Jam error 55: SIPL Field full error 56: Power off error while charging 57: WLAN module error 58: Option inconsistency error 59: Bad battery error (Caution) 60: Bad battery error (Warning) 61: Power off error 62: Barcode reader connection error 63: Barcode reading error 64: Barcode reading error (Verification start position abnormality) 65: Barcode verification error 66: NFC Module error 67: NFC Command error
6	Battery status	BT	0: Normal 1: Battery near end 2: Battery error
7	Remaining number of print	Q	000000 to 999999: 6-digit remaining number of print

*1 Described error numbers contain errors which will never occur on this printer.

[Return data format (when a command error occurs)]

[NAK]<15>₁₆

[Supplemental explanation]

- In the case of power supply, the battery status is always returned as 0: Normal.
- The media status is returned as "Media present" unless paper end has reached during printing.
- The correct value will be returned for receive buffer, ribbon end, media status, and battery when the error is updated.

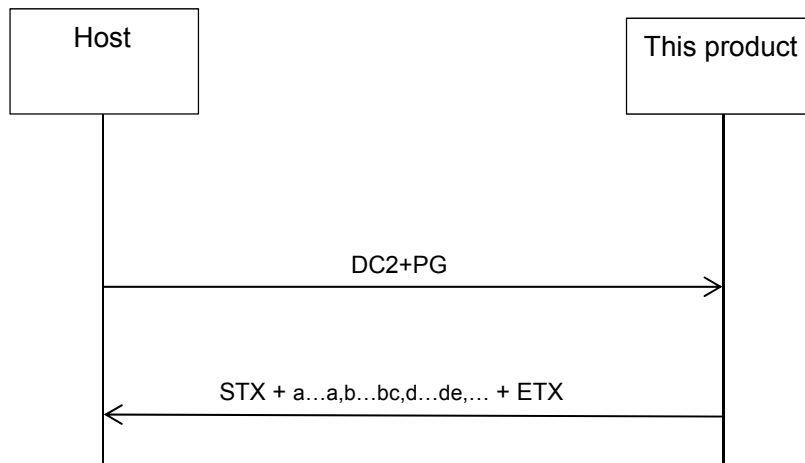

[DC2+PH] Cancel request

Command	DC2	PH	Parameter
Hexadecimal code	<12> ₁₆	<50> ₁₆ <48> ₁₆	None
Initial Value	None		

Valid range and term of command	When turning off the power	-
	Valid range	-
	Printer operation in progress	The command can be received even during the printer operation.
	Error	The command can be received even if an error is occurring.

[Function]

This command cancels print jobs and clears the entire contents of receive buffer.

[Format]

[DC2] PH

[Return data format (normal)]

[ACK]<06>₁₆

[Return data format (when a command error occurs)]

[NAK]<15>₁₆

[Supplemental explanation]

- The response data is returned after the cancel processing ends.
- After sending the cancel request command, wait for response reception before sending the next data.

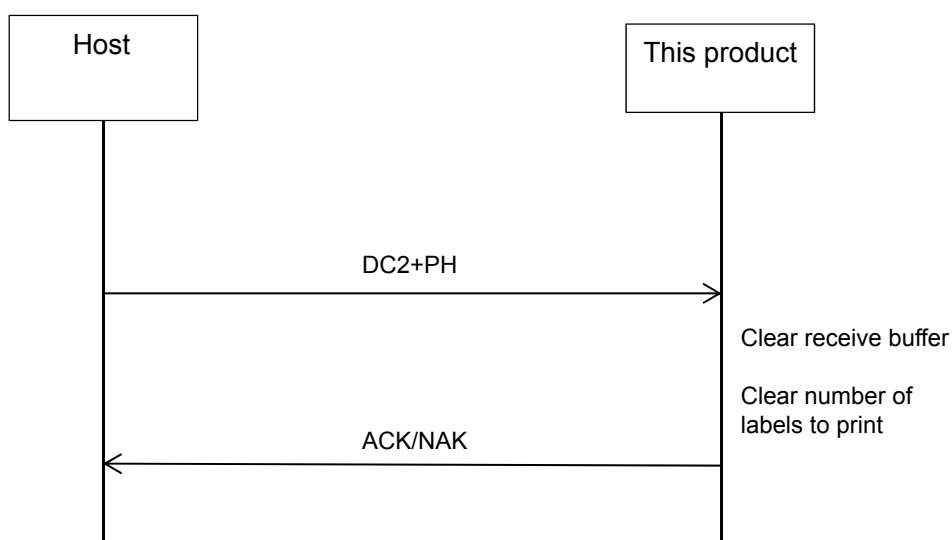

[DC2+PI] Application change

Command	DC2	PI	Parameter
Hexadecimal code	<12> ₁₆	<50> ₁₆ <49> ₁₆	,aa
Initial Value	None		

Valid range and term of command	When turning off the power	-
	Valid range	-
	Printer operation in progress	The command cannot be received during the printer operation. ([NAK] return)
	When acquiring label sensor information	Commands are not accepted while acquiring sensor information. ([NAK] reply)
	Error	The command cannot be received while an error is occurring. ([NAK] return)
	Others	Commands cannot be received other than when the screen is Online or Offline. ([NAK] return)

[Function]

This command is used to switch applications such as SBPL and SZPL.

[Format]

DC2 (12H) + PI,aa

[Parameters]

Symbol	Parameter name	Valid range	Acquisition method
aa	Identifier	SB: SBPL SZ: SZPL SP: SPOS (reserve) SC: SCPL (reserve) * SZPL and SCPL are only for PW208NX/ PW208mNX.	Two characters fixed acquisition

[Return data format (normal)]

[ACK]<06>₁₆

[Return data format (when a command error occurs)]

[NAK]<15>₁₆

[Exception processing]

Parameter name	Exception condition	
	A value outside the range is specified	The specified size and received size are different
Identifier	Command error	Invalid receive data

Terminology	Description
Command error	The data received after a command error is determined is not considered as a parameter of this command.
Invalid receive data	The data corresponding to Byte 2 and thereafter of the identifier is ignored.

[Supplemental explanation]

- Setting value of the printer will be switched when switching the application. So, obtaining and saving the setting of the application before switching, then switching it, and then put it back to the original application, after that set it by previously saved settings, and it performs the operation before switching it.

e.g.) When switching the application such as SBPL -> STCL -> SBPL

- Obtain and save the setting value of SBPL state (obtain the setting value by AIOT, [DC2]PB[EOT] and so on).
 - Switch the application to STCL.
 - Switch the application to SBPL.
 - Set the setting value obtained and saved in the step 1).
- Please send this command in a state which the printer is not working anything in Offline or Online standby state waiting state.

The result of this command sent in pause status during cancellation is not guaranteed. In such case, restart the printer.

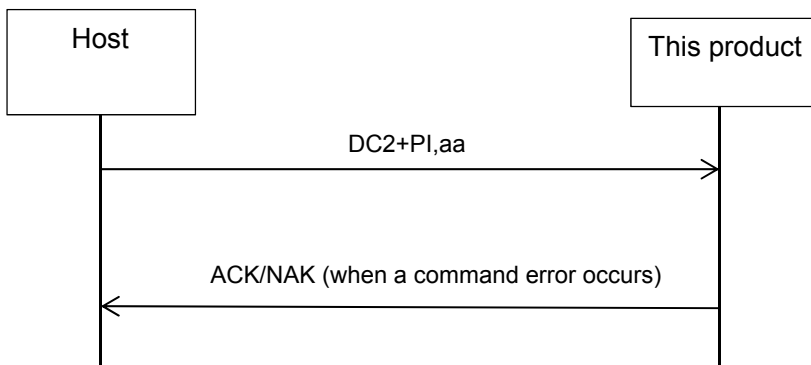

[DC2+DB] Initialization

Command	DC2	DB	Parameter
Hexadecimal code	<12> ₁₆	<44> ₁₆ <42> ₁₆	,aa
Initial Value	None		

Valid range and term of command	When turning off the power	-
	Valid range	-
	Printer operation in progress	The command cannot be received during the printer operation. ([NAK] return)
	When acquiring label sensor information	Commands are not accepted while acquiring sensor information. ([NAK] reply)
	Error	The command cannot be received while an error is occurring. ([NAK] return)

[Function]

This command initializes the printer setting.

[Format]

[DC2] DB,aa

[Parameters]

Symbol	Parameter name	Valid range	Initialization target	Acquisition method
a	Identifier	CA: Common settings initialization	[PRINTER] section	Two characters fixed acquisition
		CB: Warning function initialization	[COUNT] section	
		IL: LAN settings initialization	[LAN] section	
		IU: USB settings initialization	[USB] section	
		IW: WLAN settings initialization	[WLAN] section	
		IB: Bluetooth settings initialization	[BLUETOOTH] section	
		IN: NFC settings initialization	[NFC] section * PW208NX/PW208mNX only	
		SB: SBPL settings initialization	[SBPL] section	
		SZ: SZPL settings initialization	[SZPL] section	
SP: SPOS settings initialization	[SPOS] section (reserve)			

Symbol	Parameter name	Valid range	Initialization target		Acquisition method	
		SC: SCPL setting initialization	[SCPL] section (reserve) * PW208NX/PW208mNX only			
		CX: Registration information initialization	SBPL	Download font		
				TrueType		
			Log		Image	
				Hex Dump		
				Error		
				Key		
				Date		
				Head		
				Buffer		
			SBPL		BMP	
				Overlay		
				Format		
				PCX		
				Graphic		
				Custom Designed		
				TrueType		
			BJD			

[Return data format (normal)]

[ACK]<06>₁₆

[Return data format (when a command error occurs)]

[NAK]<15>₁₆

[Exception processing]

Parameter name	Exception condition	
	A value outside the range is specified	The specified size and received size are different
Identifier	Command error	Invalid receive data

Terminology	Description
Command error	Initialization not performed. The data received after a command error is determined is not considered as a parameter of this command.
Invalid receive data	The data corresponding to Byte 2 and thereafter is ignored.

[Supplemental explanation]

- Refer to "[DC2+PA] Printer setting command" in this document for the items to be initialized in each identifier.
- If you initialize the interface settings, a response may not be returned.

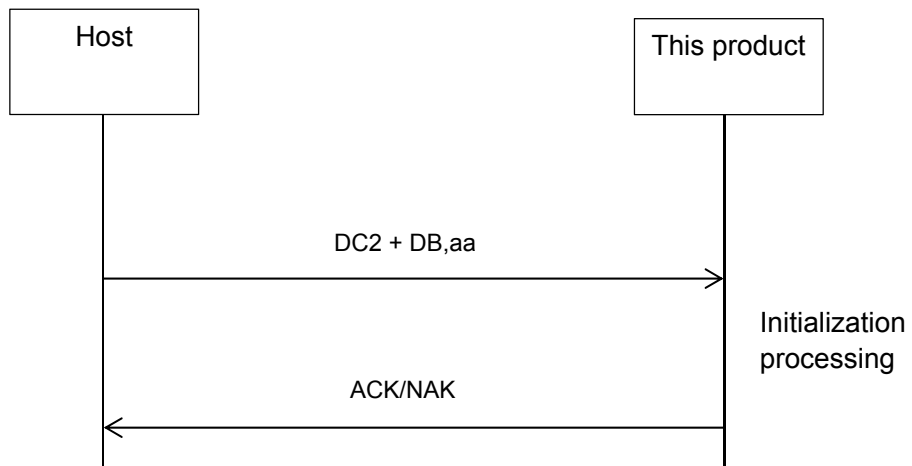

[DC2+DC] Reset

Command	DC2	DC	Parameter
Hexadecimal code	<12> ₁₆	<44> ₁₆ <43> ₁₆	None
Initial Value	None		

Valid range and term of command	When turning off the power	-
	Valid range	-
	Printer operation in progress	The command cannot be received during the printer operation. ([NAK] return)
	When acquiring label sensor information	Commands are accepted while acquiring sensor information.
	Error	The command can be received even if an error is occurring.

[Function]

This command is used to restart the printer.

[Format]

[DC2] DC

[Response (only during printing)]

[NAK]<15>₁₆

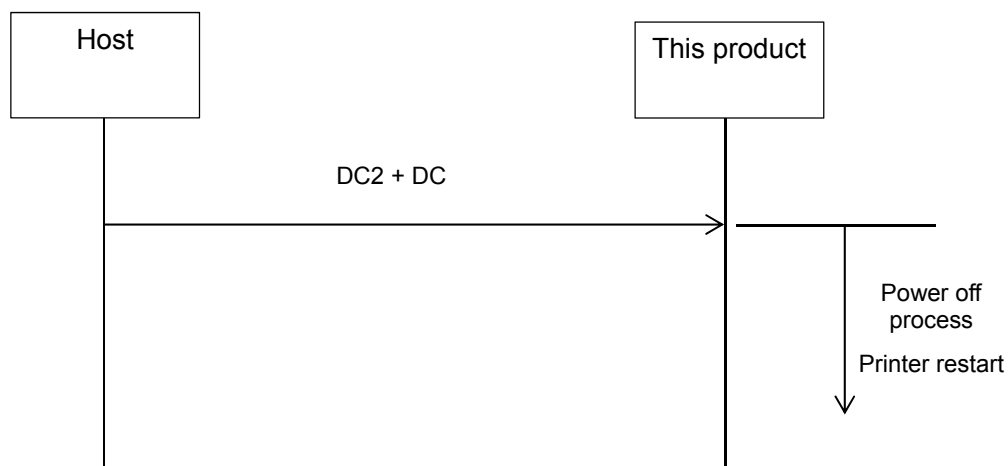

[DC2+DD] Power OFF

Command	DC2	DD	Parameter
Hexadecimal code	<12> ₁₆	<44> ₁₆ <44> ₁₆	None
Initial Value	None		

Valid range and term of command	When turning off the power	-
	Valid range	-
	Printer operation in progress	The command cannot be received during the printer operation. ([NAK] return)
	When acquiring label sensor information	Commands are accepted while acquiring sensor information.
	Error	The command can be received even if an error is occurring.

[Function]

This command is used to turn OFF the printer.

[Format]

[DC2] DD

[Response (only during printing)]

[NAK]<15>₁₆

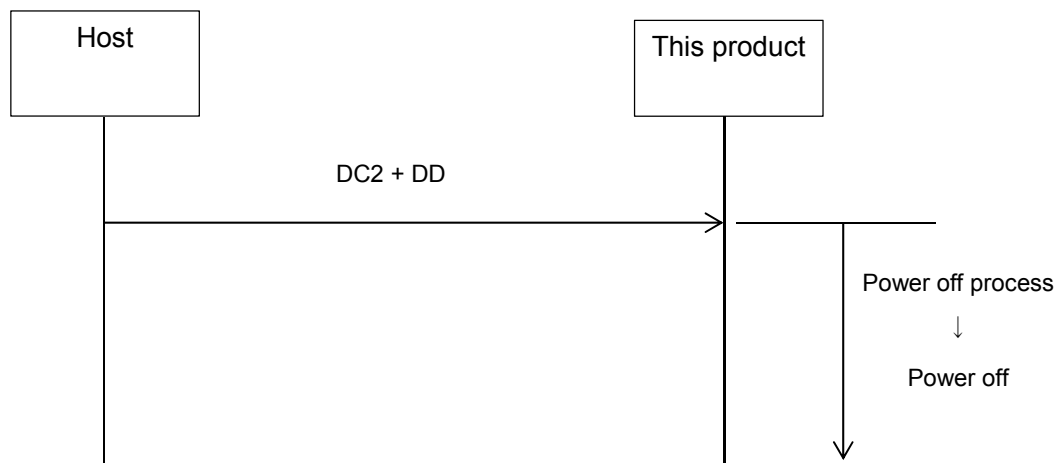

[DC2+DE] File download

Command	DC2	DE	Parameter
Hexadecimal code	<12> ₁₆	<44> ₁₆ <45> ₁₆	,aa,b,c...c,d...d,e...e
Initial Value	None		

Valid range and term of command	When turning off the power	The file is maintained.
	Valid range	-
	Printer operation in progress	The command cannot be received during the printer operation. ([NAK] return)
	When acquiring label sensor information	Commands are not accepted while acquiring sensor information. ([NAK] reply)
	Error	The command can be received even if an error is occurring.

[Function]

This command is used to download the specified file.

[Format]

[DC2]DE,aa,b,c...c,d...d,e...e

[Parameters]

Symbol	Parameter name	Valid range	Acquisition method
a	Identifier	SB: SBPL settings SZ: SZPL settings SP: SPOS settings (reserve) SC: SCPL settings (reserve) * SZPL and SCPL are only for PW208NX/ PW208mNX. CA: Common settings (when specifying other than font logo and TrueType fonts)	Two characters fixed acquisition
b	File type	0: Font/logo 1: TrueType font 2: Wireless LAN certificate (Wi-Fi Root CA) 3: Wireless LAN certificate (Wi-Fi Private Key) 4: Wireless LAN certificate (Wi-Fi Private Key) 5: Wireless LAN certificate (Wi-Fi EAP_FAST PAC_file) 6: HTTPS certificate	One character fixed acquisition
c	File name	Data within 255 characters including the following character groups. • Alphabet • Numeral • Hyphen ("-") • Underscore ("_") • Period (".")	Acquired up to ","

Symbol	Parameter name	Valid range	Acquisition method
d	File size	0 to 999999999 (byte)	Acquired up to ","
e	File data	-	Equivalent to file size

[Return data format (normal)]

[ACK]<06>₁₆

[Return data format (when a command error occurs)]

[NAK]<15>₁₆

[Return data format (when the same file name error occurs)]

1<31>₁₆

[Exception processing]

Parameter name	Exception condition		
	A value outside the range is specified	The specified size and received size are different	When the same file name
Identifier	Command error	Command error	-
File type	Command error	Command error	-
File name	Command error	-	Same file name error
File size	Command error	-	-
File data	-	Invalid receive data	-

Terminology	Description
Command error	Downloading not performed. The data received after a command error is determined is not considered as a parameter of this command.
Same file name error	The file is not saved.
Invalid receive data	The data exceeding the file size is ignored.

[Supplemental explanation]

- Send this command when printing has stopped. The content of the response data is not guaranteed even when this command is received during printing.
- When you specify SZPL for "Parameter a: Identifier ", "0: Font/logo", "1: TrueType font" settings of "Parameter b: File type" will be ignored.

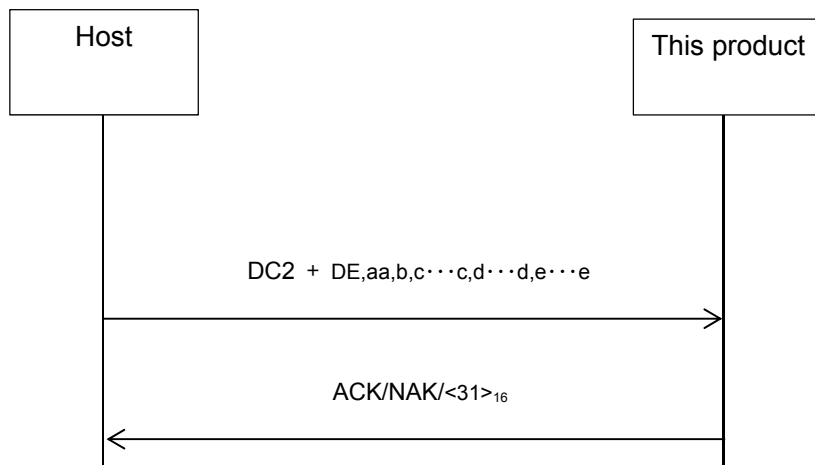

[DC2+DF] File name information acquisition

Command	DC2	DF	Parameter
Hexadecimal code	<12> ₁₆	<44> ₁₆ <46> ₁₆	,aa,b
Initial Value	None		

Valid range and term of command	When turning off the power	-
	Valid range	-
	Printer operation in progress	The command cannot be received during the printer operation. ([NAK] return)
	When acquiring label sensor information	Commands are not accepted while acquiring sensor information. ([NAK] reply)
	Error	The command can be received even if an error is occurring.

[Function]

This command returns a list of file names of the specified folder.

[Format]

[DC2]DF,aa,b

[Parameters]

Symbol	Parameter name	Valid range	Acquisition method
a	Language	SB: SBPL settings SZ: SZPL settings SP: SPOS settings (reserve) SC: SCPL settings (reserve) * SZPL and SCPL are only for PW208NX/ PW208mNX. CA: Common settings (when specifying other than font logo and TrueType fonts)	Two characters fixed acquisition
b	File type	0: Font/logo 1: TrueType font 2: Wireless LAN certificate (Wi-Fi Root CA) 3: Wireless LAN certificate (Wi-Fi Client Certificate) 4: Wireless LAN certificate (Wi-Fi Private Key) 5: Wireless LAN certificate (Wi-Fi EAP_FAST PAC_file) 6: HTTPS certificate	One character fixed acquisition

[Return data format (normal, data exists)]

[STX]a...a,b...b(c...c)[ETX]

Data example) [STX]xxxx,SBPL_001.dfl, SBPL_002.dfl[ETX]

Symbol	Parameter name	Valid range
a	Total number of data byte * This is the total number of bytes after parameter b. The delimiting comma between parameters a and b, and the ETX are not included.	Data size from the first identifier until before [ETX]
b(c)	File name	

[Return data format (normal, no file)]

[STX]0[ETX]

[Return data format (when a command error occurs)]

[NAK]<15>₁₆

[Exception processing]

Parameter name	Exception condition	
	A value outside the range is specified	The specified size and received size are different
Language	Command error	Command error
File type	Command error	Invalid receive data

Conditions	Exception condition
When directory of the specified parameter does not exist. (Condition: Never registered in the past and so on.)	Command error

Terminology	Description
Command error	The file name list is not returned. The data received after a command error is determined is not considered as a parameter of this command.
Invalid receive data	The subsequent data is ignored.

[Supplemental explanation]

- Send this command when printing has stopped. The content of the response data is not guaranteed even when this command is received during printing.
- When you specify SZPL for "Parameter a: Language", "0: Font/logo", "1: TrueType font" settings of "Parameter b: File type" will be ignored. So all file names registered with SZPL will return.

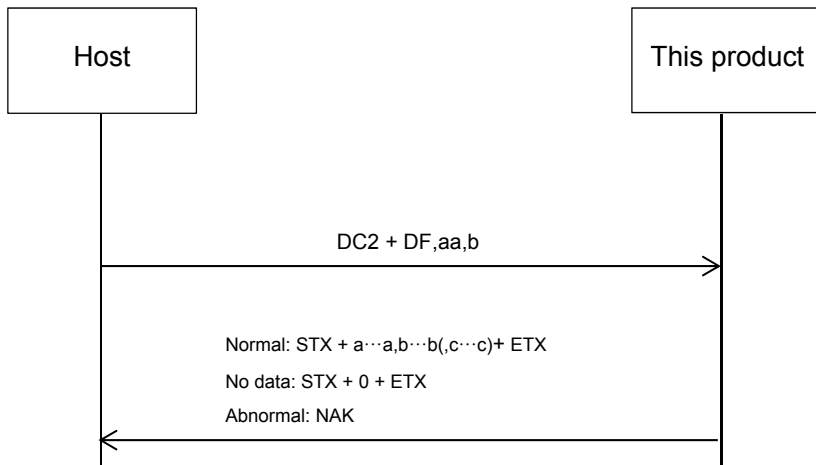

[DC2+DG] File information acquisition

Command	DC2	DG	Parameter
Hexadecimal code	<12> ₁₆	<44> ₁₆ <47> ₁₆	,aa,b,ccccc,dddddd
Initial Value	None		

Valid range and term of command	When turning off the power	-
	Valid range	-
	Printer operation in progress	The command cannot be received during the printer operation. ([NAK] return)
	When acquiring label sensor information	Commands are not accepted while acquiring sensor information. ([NAK] reply)
	Error	The command can be received even if an error is occurring.

[Function]

This command returns the specified file data information.

[Format]

[DC2]DG,aa,b,ccccc,dddddd

[Parameters]

Symbol	Parameter name	Valid range	Acquisition method
a	Language	SB: SBPL settings SZ: SZPL settings SP: SPOS settings (reserve) SC: SCPL settings (reserve) * SZPL and SCPL are only for PW208NX/ PW208mNX.	Two characters fixed acquisition
b	File type	0: Font/logo 1: TrueType font	One character fixed acquisition
c	File name size (byte)	1 to 255	Acquired up to ","
d	File name *1 Only the file name is specified.	Data including the following character groups <ul style="list-style-type: none"> • Alphabet • Numeral • Hyphen ("-") • Underscore ("_") • Period (".") 	Acquired up to the file name size

[Return data format (normal, data exists)]

[STX]a...a,b...b[ETX]

Symbol	Parameter name	Valid range
a	Total number of data byte * This is the total number of bytes after parameter b. The delimiting comma between parameters a and b, and the ETX are not included.	Data size from the first identifier until before [ETX]
d	File data	

[Return data format (normal, no data)]

[STX]0[ETX]

[Return data format (when a command error occurs)]

[NAK]<15>₁₆

[Exception processing]

Parameter name	Exception condition	
	A value outside the range is specified	The specified size and received size are different
Language	Command error	Invalid receive data
File type	Command error	Command error
File name size	Command error	Excessively small: Command error, Excessively large: Remaining data standby
File name	Command error	Excessively small: Remaining data standby, Excessively large: Command error

Terminology	Description
Command error	The file name list is not returned. The data received after a command error is determined is not considered as a parameter of this command.
Invalid receive data	The subsequent data is ignored.

[Supplemental explanation]

- When a file name is bigger than the size of the file name and still the file name is valid, it operates and finishes normally.
- When you specify SZPL for "Parameter a: Language", "0:Font/logo", "1:TrueType font" settings of "Parameter b: File type" will be ignored.

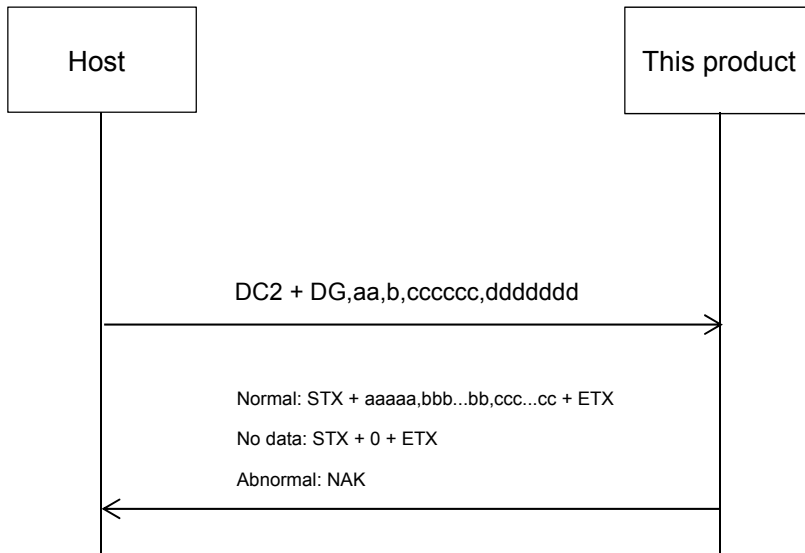

[DC2+DH] File deletion

Command	DC2	DH	Parameter
Hexadecimal code	<12> ₁₆	<44> ₁₆ <48> ₁₆	aa,b,c(,dddd,eeee)
Initial Value	None		

Valid range and term of command	When turning off the power	-
	Valid range	-
	Printer operation in progress	The command cannot be received during the printer operation. ([NAK] return)
	When acquiring label sensor information	Commands are not accepted while acquiring sensor information. ([NAK] reply)
	Error	The command can be received even if an error is occurring.

[Function]

This command is used to delete the registered files.

[Format]

[DC2]DH,aa,b,c(,dddd,eeee)

[Parameters]

Symbol	Parameter name	Valid range	Acquisition method
a	Language	SB: SBPL settings SZ: SZPL settings SP: SPOS settings (reserve) SC: SCPL settings (reserve) * SZPL and SCPL are only for PW208NX/ PW208mNX.	Two characters fixed acquisition
b	File type	0: Font/logo 1: TrueType font	One character fixed acquisition
c	Deletion type	0: File specification 1: All files	One character fixed acquisition
d	File name size (byte)	1 to 255	Acquired up to ","
e	File name * Only the file name is specified.	Data including the following character groups <ul style="list-style-type: none"> • Alphabet • Numeral • Hyphen ("-") • Underscore ("_") • Period (".") 	Acquired up to the file name size

[Return data format (normal)]

[ACK]<06>₁₆

[NAK]<15>₁₆

[Exception processing]

Parameter name	Exception condition	
	A value outside the range is specified	The specified size and received size are different
Language	Command error	Command error
File type	Command error	Command error
Deletion type	Command error	0: Command error 1: Invalid receive data ^{*1}
File name size	Command error	Command error
File name	Command error	

*1 Note that all data will be deleted even though subsequent data is not appropriate when specifying deleting all the files.

Terminology	Description
Command error	The file is not deleted. The data received after a command error is determined is not considered as a parameter of this command.
Invalid receive data	The subsequent data is ignored.

[Supplemental explanation]

- Do not specify the parameter d and e when the parameter c specifies 1 (delete all files). When specified, the parameter d and e are not handled as data of this command.
- When a file name is bigger than the size of the file name and still the file name is valid, it operates and finishes normally.
- When you specify SZPL for "Parameter a: Language", "0: Font/logo", "1: TrueType font" settings of "Parameter b: file type" will be ignored. Beware that all files registered with SZPL will be deleted if you specify "1: All files" in "Parameter c: Deletion type".

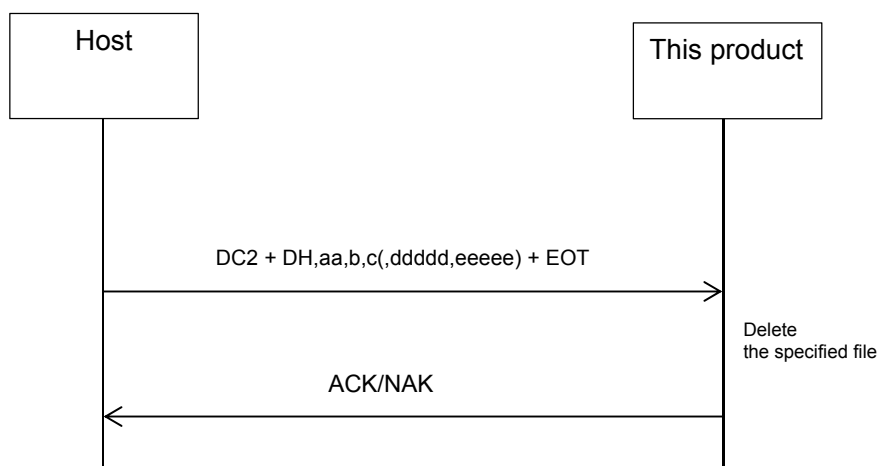

Time zone list

Time zone name	UTC offset	Cover area
Africa		
Africa/Addis Ababa	+03:00	Addis Ababa (Ethiopia)
Africa/Algiers	+01:00	Alger (Algeria)
Africa/Cairo	+02:00	Egypt
Africa/Cape Town	+02:00	South Africa
Africa/Casablanca	+00:00	Morocco
Africa/Khartoum	+03:00	Sudan
Africa/Lagos	+01:00	Nigeria
Africa/Tripoli	+02:00	Libya
Africa/Tunis	+01:00	Tunisia
Asia		
Asia/Baghdad	+03:00	Iraq
Asia/Bangkok	+07:00	Thai
Asia/Beirut	+02:00	Lebanon
Asia/Brunei	+08:00	Brunei
Asia/Calcutta	+05:30	India
Asia/Dhaka	+06:00	Bangladesh
Asia/Dubai	+04:00	Dubai
Asia/Hong Kong	+08:00	Hong Kong
Asia/Hovd	+07:00	Ubs, Khovd (Mongol)
Asia/Irkutsk	+09:00	Irkutsk Oblast (Russia)
Asia/Jakarta	+07:00	Java, Sumatra (Indonesia)
Asia/Jerusalem	+02:00	Israel
Asia/Kabul	+04:30	Afghanistan
Asia/Karachi	+05:00	Pakistan
Asia/Krasnoyarsk	+08:00	Krasnoyarsk (Russia)
Asia/Kuala Lumpur	+08:00	Malaysia
Asia/Kuwait	+03:00	Kuwait
Asia/Magadan	+12:00	Magadan (Russia), Chishima islands
Asia/Makassar	+08:00	Borneo, Sulawesi, Bali, Lesser Sunda, West Timor (Indonesian)
Asia/Manila	+08:00	Philippines
Asia/Novosibirsk	+07:00	Novosibirsk Novosibirsk Oblast (Russia)

Time zone name	UTC offset	Cover area
Asia/Oral	+05:00	West Kazakhstan Province (Kazakhstan)
Asia/Phnom Penh	+07:00	Cambodia
Asia/Pontianak	+07:00	Borneo (Indonesia)
Asia/Rangoon	+06:30	Myanmar
Asia/Riyadh	+03:00	Saudi Arabia
Asia/Saigon	+07:00	Vietnam
Asia/Seoul	+09:00	Korea
Asia/Shanghai	+08:00	Shanghai
Asia/Singapore	+08:00	Singapore
Asia/Taipei	+08:00	Taiwan
Asia/Tehran	+03:30	Iran
Asia/Tokyo	+09:00	Japan
Asia/Ulaanbaatar	+08:00	Mongol (excluding Ubs, Khovd and Bayan Ologey)
Asia/Vientiane	+07:00	Laos
Asia/Vladivostok	+11:00	Jewish Autonomous Oblast, Khabarovsk region, maritime region Central part of Sakha Republic (Russia)
Asia/Yakutsk	+10:00	Amurskaya oblast, Zabaykal'skiy Kray East part of Sakha Republic (Russia)
Asia/Yekaterinburg	+06:00	Respublika Bashkortostan, Chelyabinsk Oblast, Khantia-Mansia, Kurgan Oblast, Orenburg Oblast, Perm Krai, Sverdlovsk Oblast, Tyumen Oblast, Yamalo-Nenets Autonomous Okrug (Russia)
Australia		
Australia/Adelaide	+09:30	South Australia
Australia/Brisbane	+10:00	Queensland (Australia)
Australia/Canberra	+10:00	New South Wales (Australia)
Australia/Darwin	+09:30	Darwin (Australia)
Australia/Eucla	+08:45	Eucla (Australia)
Australia/Hobart	+10:00	Hobart (Australia)
Australia/Melbourne	+10:00	Melbourne (Australia)
Australia/Perth	+08:00	Perth (Australia)
Australia/Sydney	+10:00	New South Wales (Australia)
Caribbean		
Caribbean/Havana	-05:00	Cuba
Caribbean/Kingston	-05:00	Jamaica
Caribbean/Nassau	-05:00	Bahamas
Caribbean/Port-au-Prince	-05:00	Haiti
Caribbean/San Juan	-04:00	San Juan (Argentina)

Time zone name	UTC offset	Cover area
Caribbean/Santo Domingo	-04:00	Dominica
Central America		
Central America/Belmopan	-06:00	Belize
Central America/Guatemala	-06:00	Guatemala
Central America/Managua	-06:00	Nicaragua
Central America/Panama	-05:00	Panama
Central America/San Jose	-06:00	San Jose (America)
Central America/San Salvador	-06:00	El Salvador
Central America/Tegucigalpa	-06:00	Honduras
Europe		
Europe/Amsterdam	+01:00	Holland
Europe/Andorra	+01:00	Andorra
Europe/Athens	+02:00	Greek
Europe/Belfast	+00:00	The United Kingdom
Europe/Belgrade	+01:00	Serbia
Europe/Berlin	+01:00	Germany
Europe/Bratislava	+01:00	Czech
Europe/Brussels	+01:00	Belgium
Europe/Bucharest	+02:00	Rumania
Europe/Budapest	+01:00	Hungary
Europe/Busingen	+01:00	Busingen (Germany)
Europe/Chisinau	+02:00	Moldova
Europe/Copenhagen	+01:00	Denmark
Europe/Dublin	+00:00	Ireland
Europe/Gibraltar	+01:00	Gibraltar (The United Kingdom)
Europe/Gothenburg	+01:00	Sweden
Europe/Guernsey	+00:00	The United Kingdom
Europe/Helsinki	+02:00	Finland
Europe/Isle_of_Man	+00:00	The United Kingdom
Europe/Istanbul	+02:00	Turkey
Europe/Jersey	+00:00	The United Kingdom
Europe/Kaliningrad	+03:00	Kaliningrad (Russia)
Europe/Kiev	+02:00	Ukraine
Europe/Lisbon	+00:00	Portugal
Europe/Ljubljana	+01:00	Slovenia
Europe/London	+00:00	The United Kingdom

Time zone name	UTC offset	Cover area
Europe/Luxembourg	+01:00	Luxembourg
Europe/Madrid	+01:00	Spain
Europe/Malta	+01:00	Malta
Europe/Mariehamn	+02:00	Finland
Europe/Minsk	+03:00	Belarus
Europe/Monaco	+01:00	Monaco
Europe/Moscow	+04:00	European Russia (Russia)
Europe/Nicosia	+02:00	Cyprus
Europe/Oslo	+01:00	Norway
Europe/Paris	+01:00	France
Europe/Podgorica	+01:00	Serbia
Europe/Prague	+01:00	Czech
Europe/Reykjavik	+00:00	Iceland
Europe/Riga	+02:00	Latvia
Europe/Rome	+01:00	Italy
Europe/Samara	+04:00	Samara, Udmurtskaya (Russia)
Europe/San_Marino	+01:00	Italy
Europe/Sarajevo	+01:00	Serbia
Europe/Simferopol	+02:00	Ukrayina
Europe/Skopje	+01:00	Serbia
Europe/Sofia	+02:00	Bulgaria
Europe/Stockholm	+01:00	Sweden
Europe/Tallinn	+02:00	Estonia
Europe/Tirane	+01:00	Albania
Europe/Tiraspol	+02:00	Moldova
Europe/Torshavn	+00:00	Torshavn (Denmark)
Europe/Uzhgorod	+02:00	Ukrayina
Europe/Vaduz	+01:00	Liechtenstein
Europe/Vatican	+01:00	Italy
Europe/Vienna	+01:00	Austria
Europe/Vilnius	+02:00	Lithuania
Europe/Volgograd	+04:00	Kirov, Saratov Volgograd Oblast, Astrakhan Oblast (Russia)
Europe/Warsaw	+01:00	Poland
Europe/Zagreb	+01:00	Serbia
Europe/Zaporozhye	+02:00	Ukrayina
Europe/Zurich	+01:00	Swiss

Time zone name	UTC offset	Cover area
North America		
North America/Alaska	-09:00	Alaska (America)
North America/Aleutian	-10:00	Aleutian Islands (America)
North America/Arizona	-07:00	Arizona (America)
North America/Central	-06:00	Canada, America, Mexico
North America/Danmarkshavn	+00:00	Greenland (Denmark)
North America/East-Indiana	-05:00	Indiana (America)
North America/Eastern	-05:00	Canada, America, Mexico
North America/Edmonton	-07:00	Alberta (Canada)
North America/Halifax	-04:00	Nova Scotia (Canada)
North America/Hawaii	-10:00	Hawaii (America)
North America/Indiana-Starke	-06:00	Stark county (America)
North America/Ittoqqortoormiit	-01:00	Ittoqqortoormiit (Denmark)
North America/Mexico City	-06:00	Mexico
North America/Michigan	-05:00	Michigan (America)
North America/Montreal	-05:00	Quebec (Canada)
North America/Mountain	-07:00	Canada, America, Mexico
North America/Nuuk	-03:00	(Denmark)
North America/Pacific	-08:00	Canada, America, Mexico
North America/Qaanaaq	-04:00	(Denmark)
North America/Samoa	-11:00	Samoa
North America/St Johns	-03:30	Newfoundland, Labrador (Canada)
North America/Toronto	-05:00	Ontario (Canada)
North America/Vancouver	-08:00	British Columbia (Canada)
North America/Winnipeg	-06:00	Manitoba (Canada)
Pacific		
Pacific/Auckland	+12:00	New Zealand
Pacific/Port Moresby	+10:00	Papua New Guinea
South America		
South America/Asuncion	-04:00	Paraguay
South America/Bogota	-05:00	Colombia
South America/Buenos Aires	-03:00	Argentina
South America/Caracas	-04:30	Venezuela
South America/Guayaquil	-05:00	Ecuador
South America/La Paz	-04:00	Bolivia
South America/Lima	-05:00	Peru

Time zone name	UTC offset	Cover area
South America/Manaus	-04:00	Amazon (Brazil)
South America/Montevideo	-03:00	Uruguay
South America/Port of Spain	-04:00	Trinidad, Tobago
South America/Santiago	-04:00	Chile
South America/Sao_Paulo	-03:00	Brazil

Part 2 Interface Specification

Overview

Overview

This printer has a build-in interface on the printer to communicate data with host.

Followings are the types of build-in interface.

- USB interface (USB2.0 High-speed, MiniB, Female part)
- Bluetooth interface (Ver.3.0+EDR Class 2+ MFI model for Apple iOS)
- NFC interface

In addition, following type of interface is available as option (PW208NX only)

- Wireless LAN unit (802.11a/b/g/n)

Communication protocol

Types of communication protocol and Reception mode

- Multiple buffer mode
Able to receive data up to reception buffer near full size during print
- Bidirectional communication (Status 3, Status 4, Status5)
Monitors status of this product to carry out data communication
- Please refer to each interface for the detailed description of status 3 and status 4.
- Communication protocol for NFC (pass-through) is available only in multiple buffer mode.

Following chart shows available communication protocols.

Communication protocol	Interface			
	USB	Bluetooth	Wireless LAN (Option)	NFC
Multiple buffer Without bidirectional communication	x	x	x	o
Status 3 Multiple buffer With bidirectional communication	x	o	o	x
Status 4 Multiple buffer With bidirectional communication	o	o	o	x

o: Enabled, x: Disabled

Return status

The purpose of return status is to manage the status of this product by host, and the product return the status by request command from host.

There are two types of return status format, Status 3 and Status4. Each return status is listed below.

The product returns the status after receiving request command.

Communication protocol	Command	Command name	Remarks
Status 3	ENQ (05H)	Status request command	
	CAN (05H)	Cancel request command	
Status 4	ENQ (05H)	Status request command	
	CAN (05H)	Cancel request command	
	DLE (10H)	Print end request command	
	DC1 (11H)	Print start request command	

* In Status 3 and 4, command is processed for ESC+ENQ and ESC+CAN and returns status, but does not process command nor returns status for ESC+DLE and ESC+DC1.

Remarks

When you acquire return status from this product, please input transmission interval time after sending each command to printer.

Returning start up time will be delayed about 1.0 second when printer is in Sleep mode.

Command	Command name	Transmission interval time (Actual value)
ENQ (05H)	Status request	5 ms or more * 300ms or more for Wireless LAN
CAN (18H)	Cancel request	500 ms or more
DLE (10H)	Print end request	
DC1 (11H)	Print start request	

(1) ENQ (Status request)

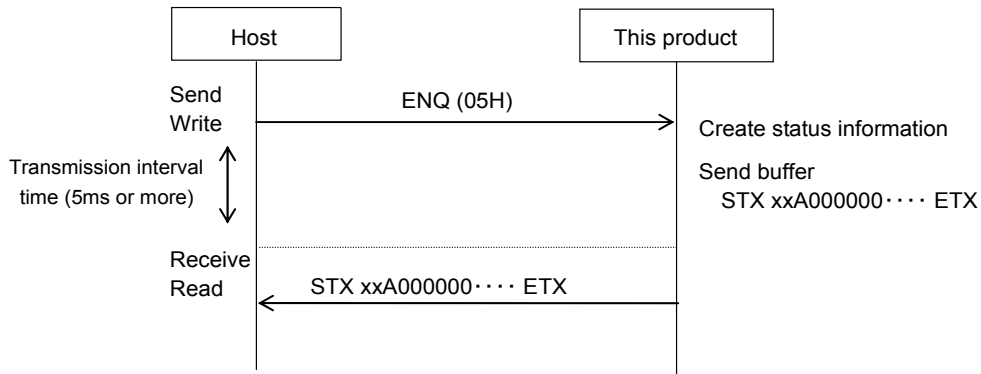

(2) CAN (Cancel request)

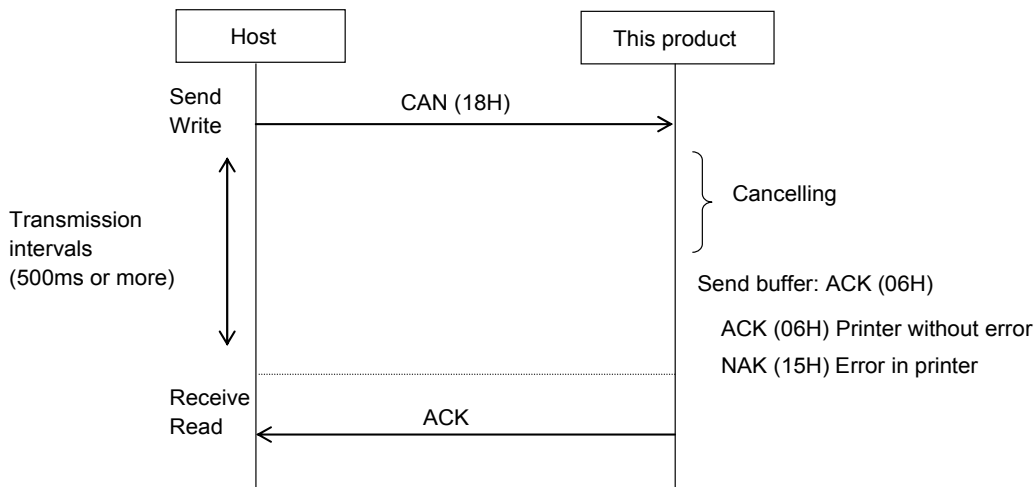

The above values are target values for queuing time until host reads ACK from printer. It varies by the interface type, setting of communication interface and communication environment.

The rough standard for transmission interval shall be 900 ms or more when you request cancel (18H) when receive buffer is near full.

Return status of Status 3

The purpose of this communication protocol is to return the product condition and reply as a status to the host by receiving three types of request commands and print command.

Following described about the details of request commands and return status.

1) Status request command

This command returns the Job ID number of received data in printing, status of this product and the number of remaining label to print to the host. All "0" (HEX 30H) is returned for print quality when the print is completed or when there is no received data. Space (HEX 20H) is returned for the Job ID numbers when command for the designation of the job ID number<ID> is not specified.

Please do not send ENQ (Status request) while sending print data (STX <A> to <Z> ETX). Status would not be returned properly or print would not be performed properly if ENQ is sent.

1. Command ENQ (HEX 05H)
STX (HEX 02H)
ETX (HEX 03H)

2. Return status, Format

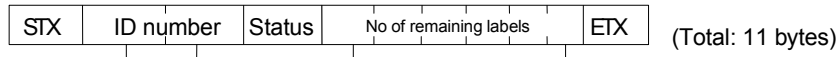

→ From 000000 to 009999

→ Set a job ID number by the command <ID> being specified in ESC <A> to <Z>. Set the job ID number of received data in printing when multiple received data exist.

3. Status list

Description		ASCII	HEX	
OFFLINE STATE	NO ERROR	0	30	
	(UNUSED) RIBBON / LABEL NEAR END ^{*1}	1	31	
	BUFFER NEAR FULL	2	32	
	(UNUSED) RIBBON / LABEL NEAR END ^{*1} & BUFFER NEAR FULL	3	33	
	BATTERY NEAR END	5	35	
	(UNUSED) BATTERY NEAR END & RIBBON/LABEL NEAR END ^{*1}	6	36	
	BATTERY NEAR END & BUFFER NEAR FULL	7	37	
	(UNUSED) BATTERY NEAR END & RIBBON/LABEL NEAR END ^{*1} & BUFFER NEAR FULL	8	38	
ONLINE STATE	WAIT TO RECEIVE	NO ERROR	A	41
		(UNUSED) RIBBON / LABEL NEAR END ^{*1}	B	42
		BUFFER NEAR FULL	C	43
		(UNUSED) RIBBON / LABEL NEAR END ^{*1} & BUFFER NEAR FULL	D	44
		BATTERY NEAR END	!	21
		(UNUSED) BATTERY NEAR END & RIBBON/LABEL NEAR END ^{*1}	"	22
		BATTERY NEAR END & BATTERY NEAR FULL	#	23
		(UNUSED) BATTERY NEAR END & RIBBON/LABEL NEAR END ^{*1} & BUFFER NEAR FULL	\$	24
	PRINTING	NO ERROR	G	47
		(UNUSED) RIBBON / LABEL NEAR END ^{*1}	H	48
		BUFFER NEAR FULL	I	49
		(UNUSED) RIBBON / LABEL NEAR END ^{*1} & BUFFER NEAR FULL	J	4A
		BATTERY NEAR END	%	25
		(UNUSED) BATTERY NEAR END & RIBBON/LABEL NEAR END ^{*1}	&	26
		BATTERY NEAR END & BATTERY NEAR FULL	'	27
(UNUSED) BATTERY NEAR END & RIBBON/LABEL NEAR END ^{*1} & BUFFER NEAR FULL		(28	
STANDBY	NO ERROR	M	4D	

		Description	ASCII	HEX
	(Waiting for dispenser/cut)	(UNUSED) RIBBON / LABEL NEAR END ^{*1}	N	4E
		BUFFER NEAR FULL	O	4F
		(UNUSED) RIBBON / LABEL NEAR END ^{*1} & BUFFER NEAR FULL	P	50
		BATTERY NEAR END)	29
		(UNUSED) BATTERY NEAR END & RIBBON / LABEL NEAR END ^{*1}	*	2A
		BATTERY NEAR END & BATTERY NEAR FULL	+	2B
		(UNUSED) BATTERY NEAR END & RIBBON / LABEL NEAR END ^{*1} & BUFFER NEAR FULL	,	2C
	ANALYZING/EDITING	NO ERROR ^{*2}	S	53
		(UNUSED) RIBBON / LABEL NEAR END ^{*1 *2}	T	54
		BUFFER NEAR FULL ^{*2}	U	55
		(UNUSED) RIBBON / LABEL NEAR END ^{*1} & BUFFER NEAR FULL ^{*2}	V	56
		BATTERY NEAR END ^{*2}	-	2D
		(UNUSED) BATTERY NEAR END & RIBBON / LABEL NEAR END ^{*1}	.	2E
		BATTERY NEAR END & BATTERY NEAR FULL	/	2F
	(UNUSED) BATTERY NEAR END & RIBBON / LABEL NEAR END ^{*1} & BUFFER NEAR FULL	@	40	
ERROR DETECTION	BUFFER OVER	a	61	
	HEAD OPEN	b	62	
	PAPER END	c	63	
	(UNUSED) RIBBON END	d	64	
	MEDIA ERROR (PRINT ERROR)	e	65	
	SENSOR ERROR / PAPER JAM ERROR	f	66	
	(UNUSED) BARCODE READ / COLLATION ERROR	f	66	
	(UNUSED) BARCODE READER CONNECTION CONFIRM ERROR	f	66	
	HEAD ERROR	g	67	
	(UNUSED) COVER OPEN	h	68	
	(UNUSED) CUTTER OPEN ERROR	h	68	
	(UNUSED) RIBBON CORE NON LOCK ERROR	h	68	
	CARD ERROR	i	69	
	(UNUSED) CUTTER ERROR	j	6A	
	OTHER ERRORS	k	6B	
	(UNUSED) CUTTER SENSOR ERROR	l	6C	
	(UNUSED) STACKER or REWIDER FULL; WINDING FULL	m	6D	

Description		ASCII	HEX
	(UNUSED) RFID TAG ERROR	o	6F
	(UNUSED) RFID PROTECT ERROR	p	70
	BATTERY ERROR	q	71

*1 It does not detect LABEL NEAR END.

*2 Print quantity may not be set properly depending on timing of edit and analysis.

*3 BUFFER OVER may occur or may not occur, it depends on interface.

2) Cancel request command

This command enables to cancel print jobs and to clear the entire contents of receive buffer.

The status of this product after finishing process is returned.

* When the cancel request command has been sent, wait more than 500 ms before sending the next data.

* This command shall not be used while sending other data like print data.

1. Command CAN (HEX 18H)
2. Return status list

Return status	Description
ACK (HEX 06H)	No error in this product
NAK (HEX 15H)	Error in this product

3) Print command

Print starts after receiving print command (STX <A> to <Z> ETX)

The status of this product after receiving command is returned.

1. Return status list (The status of this product)

Return status	Description
ACK (HEX 06H)	No error in this product
NAK (HEX 15H)	Error in this product

Note: ACK is returned instead of NAK when this product is in Sleep mode or in WakeUp mode for Ver1.7.3-r1 or after.

Note: If ESC+Z is received and error occurs at the same time when printer wakes up from Sleep mode, there is a timing to return ACK, but this rarely occurs in operation because status is checked by ENQ.

Command example of Job ID number <ID>

```
<A>
<ID>01
<V>100<H>100<P>2<L>0202<X20>,ABC
<Q>1
<Z>
```

Please refer to "Job ID Number <ID>" in this document for details.

Return status of Status 4

This communication protocol is used to return the condition of this product and reply as a status to the host by receiving four types of request commands and print commands.

The following describes about commands and return status.

1) Status request command

This command returns the job ID number of receiving data in printing, the status of this product, the number of remaining label to print, and job name to host. All "0" (HEX 30H) is returned for print quality when the print is completed or when there is no received data. A "space" (HEX 20H) is returned for the job ID when Job ID Number <ID> is not specified.

Please do not send ENQ (Status request) while sending print data (STX <A> to <Z> ETX). Status would not be returned properly or print would not be performed properly if ENQ is sent.

1. Command ENQ (HEX 05H)
2. Return status, Format

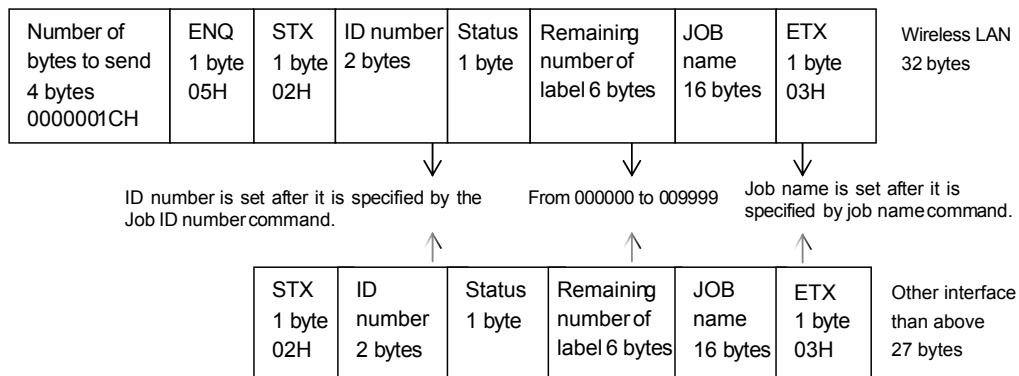

3. Return status list

Description		ASCII	HEX
OFFLINE STATE	NO ERROR	0	30
	(UNUSED) RIBBON/LABEL NEAR END ^{*1}	1	31
	BUFFER NEAR FULL	2	32
	(UNUSED) RIBBON/LABEL NEAR END ^{*1} & BUFFER NEAR FULL	3	33
	PRINT HALT (NO ERROR)	4	34
	BATTERY NEAR END	5	35
	(UNUSED) BATTERY NEAR END & RIBBON/LABEL NEAR END ^{*1}	6	36
	BATTERY END & BUFFER NEAR FULL	7	37
(UNUSED) BATTERY NEAR END & RIBBON/LABEL NEAR END ^{*1} & BUFFER NEAR FULL	8	38	
ONLINE STATE	WAIT TO RECEIVE	NO ERROR	A
	(UNUSED) RIBBON/LABEL NEAR END ^{*1}	B	41
	BUFFER NEAR FULL	C	42
	(UNUSED) RIBBON/LABEL NEAR END ^{*1} & BUFFER NEAR FULL	D	43
	PRINT HALT (NO ERROR)	E	44

Description		ASCII	HEX
	BATTERY NEAR END	!	21
	(UNUSED) BATTERY NEAR END & RIBBON/ LABEL NEAR END ^{*1}	"	22
	BATTERY END & BUFFER NEAR FULL	#	23
	(UNUSED) BATTERY NEAR END & RIBBON/ LABEL NEAR END ^{*1} & BUFFER NEAR FULL	\$	24
PRINTING	NO ERROR	G	47
	(UNUSED) RIBBON/LABEL NEAR END ^{*1}	H	48
	BUFFER NEAR FULL	I	49
	(UNUSED) RIBBON/LABEL NEAR END ^{*1} & BUFFER NEAR FULL	J	4A
	PRINT HALT (NO ERROR)	K	4B
	BATTERY NEAR END	%	25
	(UNUSED) BATTERY NEAR END & RIBBON/ LABEL NEAR END ^{*1}	&	26
	BATTERY END & BUFFER NEAR FULL	'	27
	(UNUSED) BATTERY NEAR END & RIBBON/ LABEL NEAR END ^{*1} & BUFFER NEAR FULL	(28
STANBY (waiting for dispenser/ cutter)	NO ERROR	M	4D
	(UNUSED) RIBBON/LABEL NEAR END ^{*1}	N	4E
	BUFFER NEAR FULL	O	4F
	(UNUSED) RIBBON/LABEL NEAR END ^{*1} & BUFFER NEAR FULL	P	50
	PRINT HALT (NO ERROR)	Q	51
	BATTERY NEAR END)	29
	(UNUSED) BATTERY NEAR END & RIBBON/ LABEL NEAR END ^{*1}	*	2A
	BATTERY END & BUFFER NEAR FULL	+	2B
	(UNUSED) BATTERY NEAR END & RIBBON/ LABEL NEAR END ^{*1} & BUFFER NEAR FULL	,	2C
ANALYZING/ EDITING	NO ERROR ^{*2}	S	53
	(UNUSED) RIBBON/LABEL NEAR END ^{*1 *2}	T	54
	BUFFER NEAR FULL ^{*2}	U	55
	(UNUSED) RIBBON/LABEL NEAR END ^{*1} & BUFFER NEAR FULL ^{*2}	V	56
	PRINT HALT (NO ERROR)	W	57
	BATTERY NEAR END	-	2D
	(UNUSED) BATTERY NEAR END & RIBBON/ LABEL NEAR END ^{*1}	.	2E

Description		ASCII	HEX
	BATTERY END & BUFFER NEAR FULL	/	2F
	(UNUSED) BATTERY NEAR END & RIBBON/ LABEL NEAR END ^{*1} & BUFFER NEAR FULL	@	40
ERROR DETECTION	HEAD OPEN	b	62
	PAPER END	c	63
	(UNUSED) RIBBON END	d	64
	MEDIA ERROR (PRINT ERROR)	e	65
	SENSOR ERROR / PAPER JAM ERROR	f	66
	(UNUSED) BARCODE READ / COLLATION ERROR	f	66
	(UNUSED) BARCODE READER CONNECTION CONFIRM ERROR	f	66
	HEAD ERROR	g	67
	(UNUSED) COVER OPEN	h	68
	(UNUSED) CUTTER OPEN ERROR	h	68
	(UNUSED) RIBBON CORE NON LOCK ERROR	h	68
	CARD ERROR	i	69
	(UNUSED)CUTTER ERROR	j	6A
	OTHER ERRORS	k	6B
	(UNUSED) CUTTER SENSOR ERROR	l	6C
	(UNUSED) STACKER or REWIDER FULL; WINDING FULL	m	6D
	(UNUSED) RFID TAG ERROR	o	6F
(UNUSED) RFID PROTECT ERROR	p	70	
BATTERY ERROR	q	71	

*1 It does not detect LABEL NEAR END.

*2 Print quantity may not be set properly depending on timing of edit and analysis.

- **The root cause of receive buffer near full**

"Receive buffer near full" occurs when the buffer's free space goes down to 0.95 MB out of the 2.95 MB of receive buffer.

- **Contributing factor for cancellation of receive buffer near full**

"Receive buffer near full" is cleared when the buffer's free space decreased to 1.95 MB.

2) Cancel request command

This command enables to cancel print jobs and to clear the entire contents of receive buffer.

The status of this product after finishing process is returned.

* When the cancel request command has been sent, wait more than 500 ms before sending the next data.

* Please do not send CAN (Cancel request command) while STX <A> to <Z> ETX. CAN (Cancel request command) would not be sent properly.

1. Command CAN (HEX 18H)
2. Return status list

Return status	Description
ACK (HEX 06H)	No error in this product
NAK (HEX 15H)	Error in this product

Note: ACK is HEX 0000000106H and NAK is HEX 0000000115H for Wireless LAN interface.

3) Print command

This command (<A> to <Z>) starts the printing process.

The status of this product after receiving command is returned.

1. Return status list

Bluetooth interface

Return status	Description
ACK (HEX 06H)	No error in this product
NAK (HEX 15H)	Error in this product

Note: ACK is returned instead of NAK when this product is in Sleep mode or in WakeUp mode for Ver1.7.3-r1 or after.

Interface other than Bluetooth

Return status	Description
NONE	No response is returned.

4) Print stop request command

This command halts the printing process.

The status of this product after receiving command is returned.

1. Command DLE (HEX 10H)
2. Return status list

Return status	Description
ACK (HEX 06H)	No error in this product
NAK (HEX 15H)	Error in this product

Note: ACK is HEX 0000000106H and NAK is HEX 0000000115H for Wireless LAN interface.

Please do not send DLE (Print stop request command) while STX <A> to <Z> ETX. DLE (Print stop request command) would not be sent properly. Font data, graphic data, barcode data will not be processed as DLE transmission (Print stop request).

5) Print start request command

This command releases the pause mode of the printer and restarts the printing process.

The status of this product after receiving command is returned.

1. Command DC1 (HEX 11H)
2. Return status list

Return status	Description
ACK (HEX 06H)	No error in this product

Return status	Description
NAK (HEX 15H)	Error in this product

Note: ACK is HEX 0000000106H and NAK is HEX 0000000115H for Wireless LAN interface.

Status 3

The purpose of this communication protocol is to control the status of this product on host and to return status from this product with request command from host.

Please refer to "Return status of Status 3" for the details of request command and return status.

Return sequence

Please refer to "Printer Status" in "Wireless LAN" described below when Wireless LAN interface is used.

1) Normal process

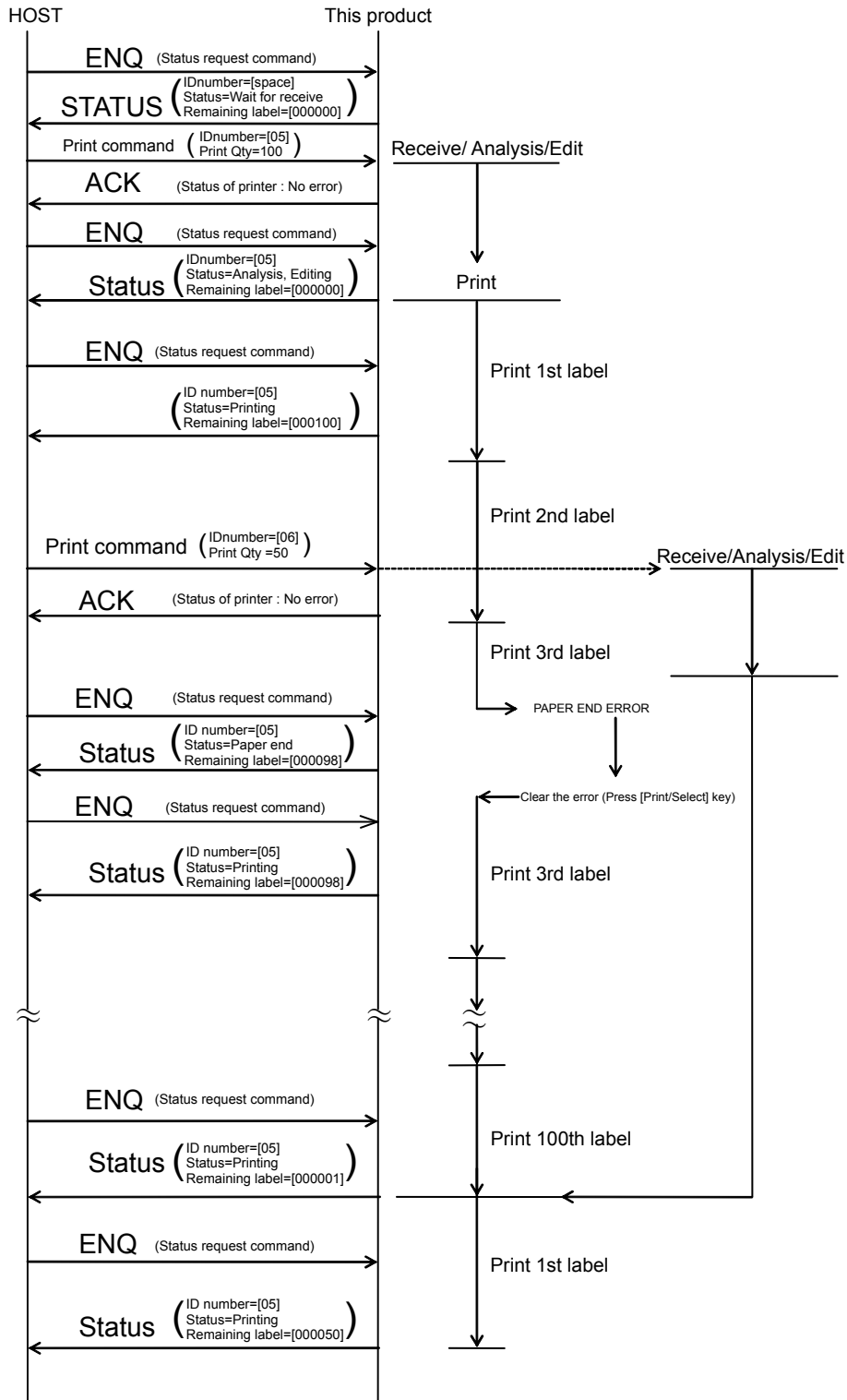

2) Cancel request command

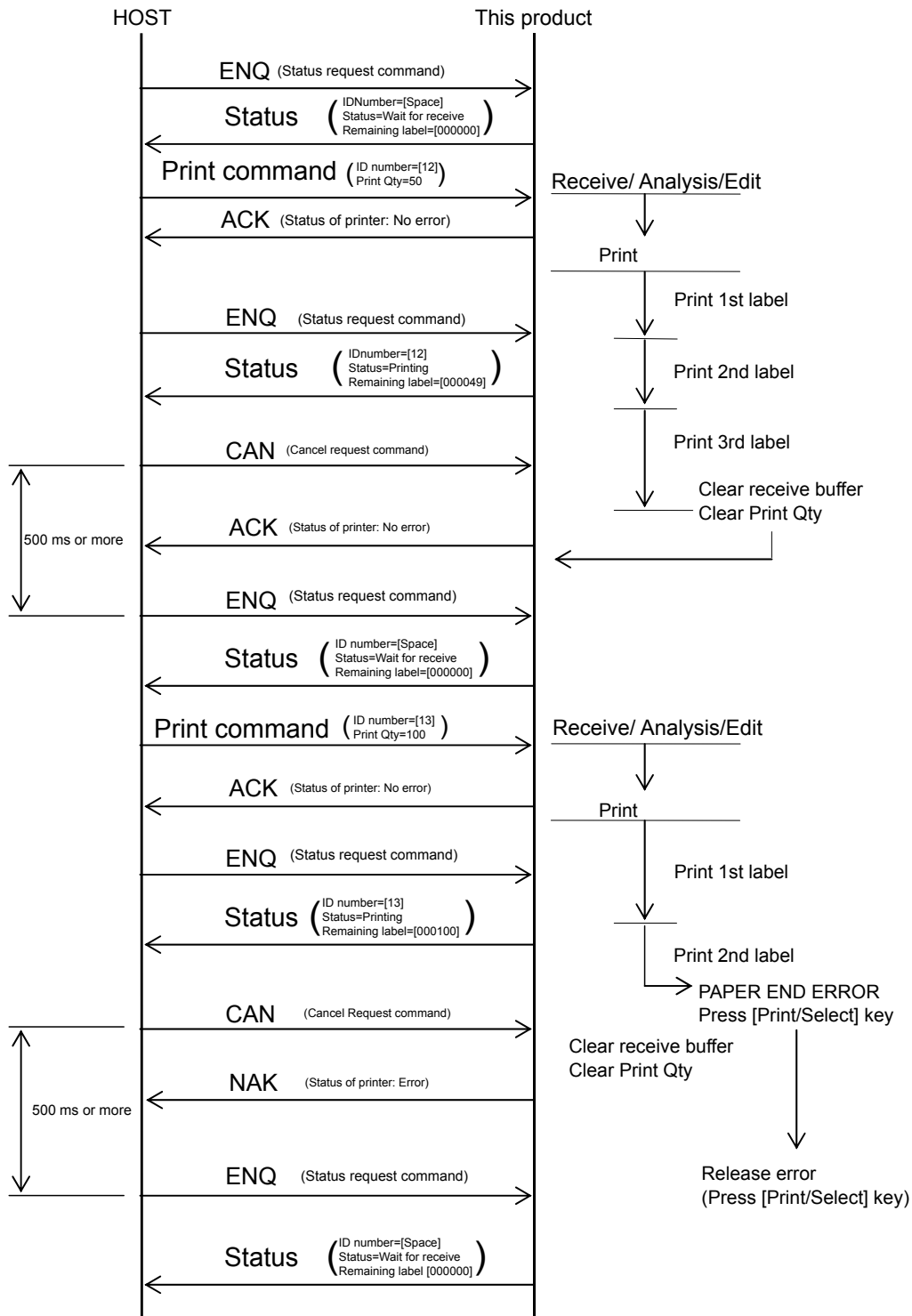

Reference flow chart

Please refer to the following flow chart for creating program at host with this protocol.

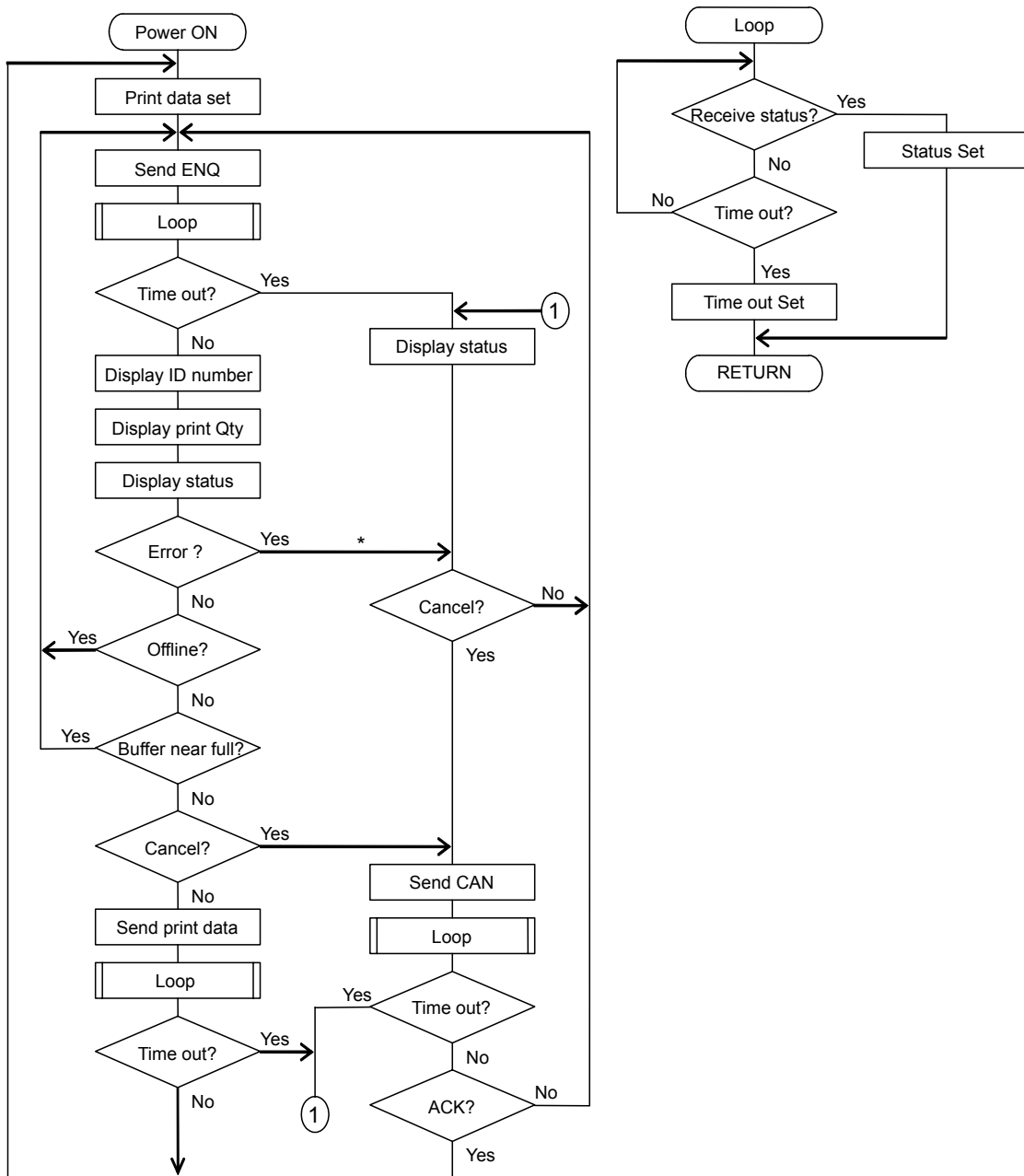

* Please make sure that error in this product has been cleared by ENQ then send print data when this product detects an error by checking status.

Status 4

The purpose of this communication protocol is to control the status of this product on host and to return status from this product with request command from host.

Please refer to [Returns status of Status 4] for the details of request command and return status.

Return sequence

Please refer to "Printer Status" in "Wireless LAN" described below when Wireless LAN interface is used.

1) Normal process

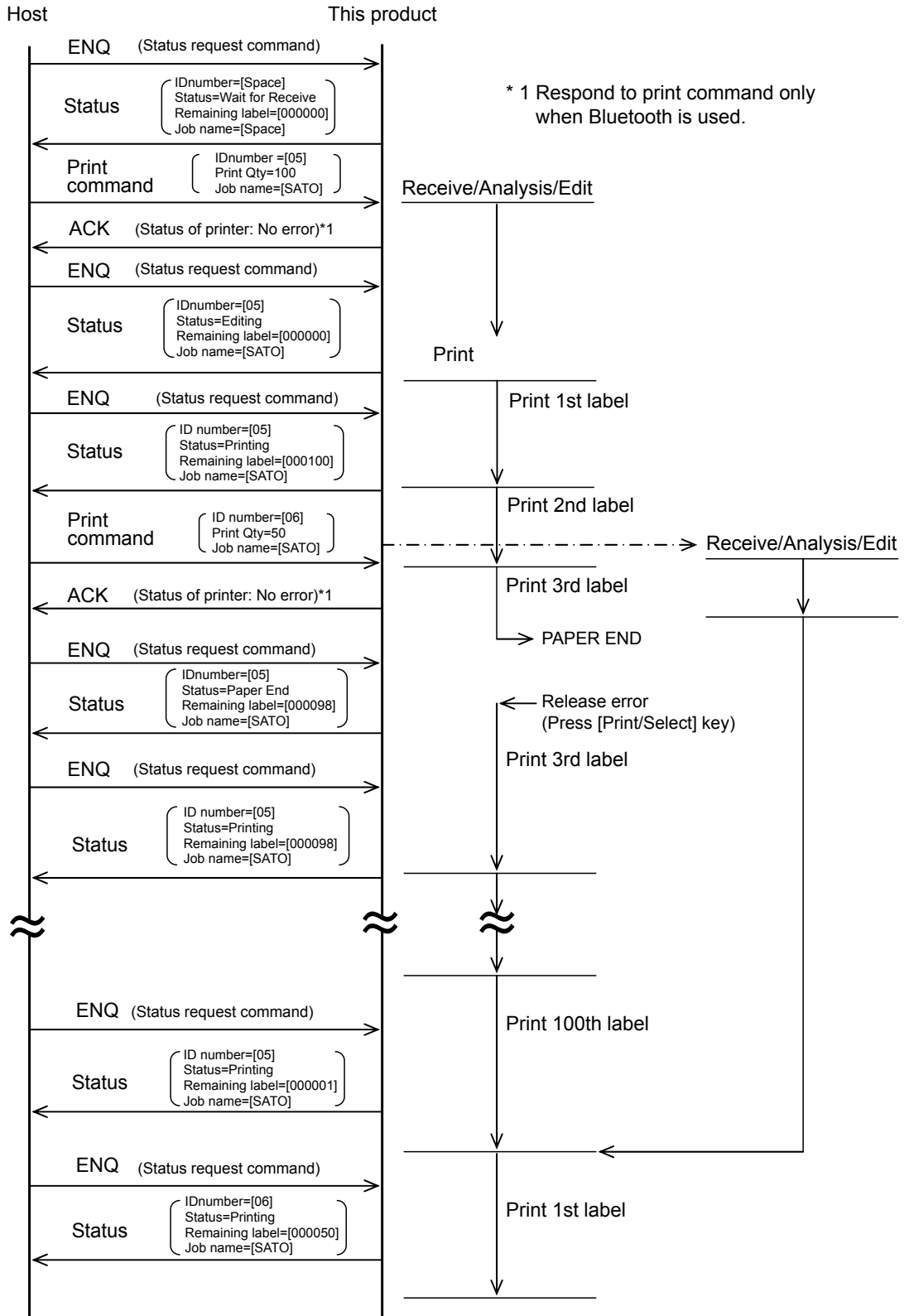

USB

Basic Specifications

USB interface of this product comply with USB2.0 standard.

Interface

Mini B type (Female part)

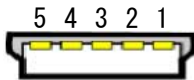

Communication settings

Setting range in communication settings mode

Item	Setting value	Initial Value
Protocol	Status 4	Status 4

Connector

Mini B plug

Length of cable: 5 m or less (Twisted Pair Shielded)

Version

USB2.0 High-speed

Receive buffer size

2.95 MB

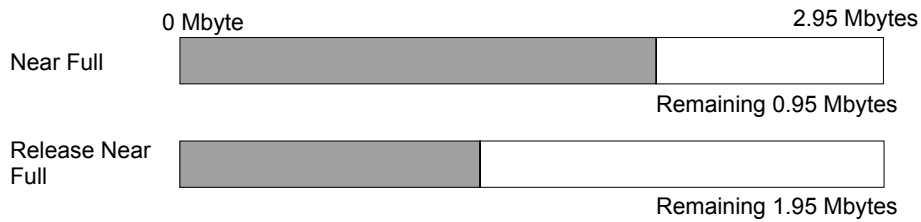

Layout plan for connector pin

Pin number	Name
1	VBus
2	-Data(D-)
3	+Data(D+)
4	USB ID
5	GND

Wireless LAN

Basic Specifications



Protocol

Following communication protocol is configurable;

Setting item	Setting range
Protocol	Return Status 3 Return Status 4 (ENQ response mode) (Initial value)

Display Wi-Fi status

Display radio field intensity with icon on screen.

Icon	Name	Description
	Disconnected	Wi-Fi is enabled but is disconnected.
	Wi-Fi radio field intensity	Wi-Fi is connected. Display radio field intensity (4 levels)

Display Wi-Fi information

Information/ Wi-Fi Status screen shows Wi-Fi information. The information is updated every 10 seconds.



Specifications of Wi-Fi

1) Communications Standards

Comply with IEEE802.11a/b/g/n

Communications Standards	Frequency band	Maximum speed
IEEE802.11b	2.4 GHz	11 Mbps
IEEE802.11a	5 GHz	54 Mbps
IEEE802.11g	2.4 GHz	54 Mbps
IEEE802.11n	2.4/5 GHz	135 Mbps

2) Connection conditions for IEEE802.11n

MCS value 0-6 supported

MCS value 7 is working, but performance is not guaranteed.

Band width	Guard interval	Communication speed	
		MCS6	MCS7 (reference value)
20 MHz	800 ns	58.5 Mbps	65.0 Mbps
	400 ns	65.0 Mbps	72.2 Mbps
40 MHz	800 ns	121.5 Mbps	135.0 Mbps
	400 ns	135.0 Mbps	150.0 Mbps

3) Wireless LAN communication mode

Infrastructure mode

Ad Hoc mode

* IEEE802.11n works only in Infrastructure mode.

4) Channel for use

1 to 13 channel (when it is connected with IEEE802.11b/g/n)

* Access point channel is used in Infrastructure mode.

* Channel of communication partner is used if communication partner is [Waiting to be connected] at first in Ad Hoc mode.

* Setting range is 3 to 11 channel when band width of IEEE802.11n is 40 MHz (regardless of region setting).

5) SSID

Set 1 to 32 of alphanumeric characters or code (available range of character is 20H to 7EH)

6) Wireless LAN security

Infrastructure mode

Wireless LAN security	None	
	WEP	
	WPA+WPA2	
	WPA2	
	Dynamic WEP	
WEP	Open System	
	Shared Key	
WEP Key	1 to 4	
WEP Key character string	64 bit: 5 ASCII / 10 hex 128 bit: 13 ASCII / 26 hex	
WPA+WPA2, WPA2	PSK	PSK Key 8 to 64 ASCII 64 hex
	Enterprise (802.1x)	EAP Conf
	CCKM	
EAP	FAST	MSCHAP v2
		GTC

		TLS
	LEAP	
	PEAP	MSCHAP v2
		GTC
		TLS
		MD5
		OTP
	TLS	
	TTLS	MSCHAP v2
		MSCHAP
		CHAP
		PAP
		EAP-GTC
		EAP-MD5
		EAP-MSCHAP v2
		EAP-OTP
		EAP-TLS

Ad Hoc mode

None	-
WEP	Open System
	Shared Key
WEP Key	1 to 4
WEP Key character string	64 bit: 5 ASCII / 10 hex 128 bit: 13 ASCII / 26 hex

7) Supports WPS 2.0 (Wi-Fi Simple Configuration Technical Specification v2.0.0)

8) Able to communicate with 6 devices at the maximum in Ad Hoc mode.

9) Obtained CCX certificate (Ver4.0)

10) Supports Wi-Fi Direct

Note

Please consult with your system administrator and make sure that there will be no affect on medical devices and equipment when printer is used near the medical devices and equipment.

Receive buffer size

2.95 MB

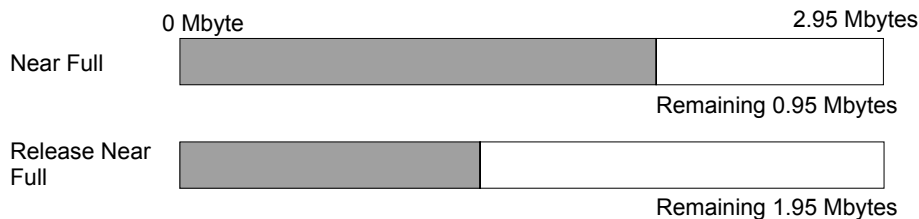

Network setting/Display items

Following chart lists configurable items and items can be referred.

TCP/IP-related settings

Setting items	Setting range	Initial value (Factory setting)
DHCPv4 setting	Enabled/Disabled	Enabled
IPv4 address	0.0.0.0 to 255.255.255.255	0.0.0.0
IPv4 subnet mask	0.0.0.0 to 255.255.255.255	255.255.255.0
IPv4 default gateway	0.0.0.0 to 255.255.255.255	0.0.0.0
IPv4 DNS primary address	0.0.0.0 to 255.255.255.255	0.0.0.0
IPv4 DNS secondary address	0.0.0.0 to 255.255.255.255	0.0.0.0
IPv6 address resolution	Disable / DHCP / AUTO / Static	Disable
IPv6 address	AAAA:BBBB:CCCC:DDDD:EEEE:FFFF:GGGG:HHHH :: ASCII for 128 bit A to H is "0" to "9", "A" to "F". A to H can be omitted.	
IPv6 default router	AAAA:BBBB:CCCC:DDDD:EEEE:FFFF:GGGG:HHHH :: ASCII for 128 bit A to H is "0" to "9", "A" to "F". A to H can be omitted.	
IPv6 subnet pre-fix	1 to 128	64
IPv6 DNS primary address	AAAA:BBBB:CCCC:DDDD:EEEE:FFFF:GGGG:HHHH :: ASCII for 128 bit A to H is "0" to "9", "A" to "F". A to H can be omitted.	
ARP extension	Enabled/Disabled	Enabled
Cycle of ARP notification	"0" to "600" (seconds)	300
KEEPALIVETIME	"30" to "300" (seconds)	180
KEEPALIVECOUNT	"1" to "99" (times)	17
SOCKET_CANCEL	"0": Normal mode "1": Compatible mode	0
Communication protocol (SBPL)	Status 4 (ENQ) / Status 3 / none	Status 4 (ENQ)

Setting items	Setting range	Initial value (Factory setting)
Port number 1	1 to 65535	1024
Port number 2	1 to 65535	1025
Port number 3	1 to 65535	9100
SNMP settings	Enabled/Disabled	Disabled
SNMP read-only version	1 2c 3 1 2c 3 Disabled	1 2c 3
SNMP read-only community name	Maximum of 32 character strings	public
SNMP read-only user name	8 to 32 of character string	rouser
SNMP read-only security	none / Authentication / Privacy (with code language)	none
SNMP read-only authentication protocol	MD5 / SHA	MD5
SNMP read-only authentication password	8 to 32 of character string	mypassword
Protocol for SNMP read-only authentication	DES/AES	DES
Password for SNMP read-only code language	8 to 32 of character string	mypassword
SNMP read-write only version	1 2c 3 1 2c 3 Disabled	1 2c 3
SNMP read-write only community name	Maximum of 32 character strings	private
SNMP read-write only user name	8 to 32 of character string	rwuser
SNMP read-write only security	none / Authentication / Privacy (with code language)	none
SNMP read-write only protocol	MD5/SHA	MD5
SNMP read-write only authentication password	8 to 32 of character string	mypassword
Protocol for SNMP read-write only code language	DES/AES	DES
Password for SNMP read-write only code language	8 to 32 of character string	mypassword
SNMP trap	Enabled/Disabled	Disabled
SNMP trap version	SNMPv1 / SNMPv2c / SNMPv3	SNMPv1
SNMP trap Destinations	Destination1 / Destination2 / Destination3	Destination1
SNMP trap IP Version	IPv4 / IPv6	IPv4
SNMP IPv4 trap Destination1	AAA.BBB.CCC.DDD A to D is "0" to "255"	0.0.0.0

Setting items	Setting range	Initial value (Factory setting)
	Allow "0" to "255" for A to D	
SNMP IPv6 trap Destination1	AAAA:BBBB:CCCC:DDDD:EEEE:FFFF:GGGG:HHHH :: ASCII for 128 bit A to H is "0" to "FFFF" A to H can be omitted.	
SNMP IPv4 trap Destination2	AAA.BBB.CCC.DDD A to D is "0" to "255" Allow "0" to "255" for A to D	0.0.0.0
SNMP IPv6 trap Destination2	AAAA:BBBB:CCCC:DDDD:EEEE:FFFF:GGGG:HHHH :: ASCII for 128 bit A to H is "0" to "FFFF" A to H can be omitted.	
SNMP IPv4 trap Destination3	AAA.BBB.CCC.DDD A to D is "0" to "255" Allow "0" to "255" for A to D	0.0.0.0
SNMP IPv6 trap Destination3	AAAA:BBBB:CCCC:DDDD:EEEE:FFFF:GGGG:HHHH :: ASCII for 128 bit A to H is "0" to "FFFF" A to H can be omitted.	
SNMP trap community	Maximum of 32 character string * Encrypted data	trapcom
SNMP trap user name	Maximum of 32 character string * Encrypted data	trapuser
SNMP trap engine ID	Even number 10 digits to 64 digits	Number generated from MAC address
SNMP trap security	none / Authentication / Privacy (with code language)	none
SNMP trap authentication protocol	MD5 / SHA	MD5
SNMP trap authentication password	8 to 32 digits of character strings * Encrypted data	mypassword
SNMP trap encryption protocol	DES / AES	DES
SNMP trap encryption password	8 to 32 digits of character strings * Encrypted data	mypassword
LPD	Enabled/Disabled	Disabled
FTP	Enabled/Disabled	Disabled
FTP time out	"10" to "3600" (seconds)	300

Wireless LAN setting/Display items

Following chart lists configurable sections and variables and sections/variables can be referred.

Variable name	Setting range	Initial value (Factory setting)
Wireless LAN operation mode	Infrastructure/Ad Hoc	Ad Hoc
SSID	1 to 32 of character strings ^{*1}	SATO_PRINTER
Hidden SSID	Enabled/Disabled	Enabled
Channel number	1 to 13 * Maximum value varies by destination	6
Infrastructure mode network security	None WEP WPA+WPA2 WPA2 Dynamic WEP	None
Ad Hoc mode network security	WEP/None	None
WEP key	Open System / Shared Key	Open System
WEP key 1	Encryption character string of character	NULL
WEP key 2	Encryption character string of character	NULL
WEP key 3	Encryption character string of character	NULL
WEP key 4	Encryption character string of character	NULL
WEP key index	1 to 4	1
WPA authentication	Personal (PSK) Enterprise (802.1x) CCKM	Personal (PSK)
PSK	8-63 ASCII or 64 HEX digits	NULL
EAP Mode	FAST LEAP PEAP TLS TTLS	FAST
Inner Method if EAP Mode=FAST	MSCHAPv2 GTC TLS	MSCHAPv2
Inner Method if EAP Mode=PEAP	MSCHAPv2 GTC MD5 OTP TLS	MSCHAPv2
Inner Method if EAP Mode=TTLS	MSCHAPv2 MSCHAP CHAP PAP EAP-GTC EAP-MD5	MSCHAPv2

Variable name	Setting range	Initial value (Factory setting)
	EAP-MSCHAPv2 EAP-OTP EAP-TLS	
EAP authentication user name	0 to 63 characters* ¹	NULL
EAP authentication password	0 to 32 of encryption character strings	NULL
Anon. Outer ID If EAP Mode=FASE, PEAP, TTLS	0 to 63 characters* ¹	NULL
Verify Server Cert. Not for LEAP	Enabled/Disabled	Enabled
Private Key P/W	0 to 64 of encryption character strings	NULL
PAC Auto Provisioning	Enabled/Disabled	Disabled
PAC Password	0 to 64 of encryption character strings	NULL

*1 Setting range is HEX 20-7EH.

Specifications of software

Supported protocol: TCP/IP

Network layer: IPv4, IPv6, ICMP

Session layer: TCP, UDP

Application layer: LPR, FTP, DHCP, HTTP/HTTPS, SNMPv1, SNMPv2c, SNMPv3

1. LPR of TCP/IP, FTP, and Dedicated Socket protocol can be used for sending print data.
2. Status of printer can be obtained by dedicated Socket protocol.

Specifications of TCP/IP

TCP/IP protocol environment has LPR and FTP for print. DHCP can be used for setting address.

Specifications of LPR

LPR protocol complies with RFC1179 and handles a list of theoretical printer names as queue name.

The queue name is "lp".

Send sequence of data file and control file in the job does not affect on print operation when the job is sent by LPR.

- * Job deletion is not supported by LPR.
- * Specifications of LPR can be used only in Status 4: ENQ response.
- * Missing label or duplicated image may occur when many labels are printed by LPR due to the specifications of Windows.
- * Banner page print is not supported.
- * Multiple sessions cannot be established at the same time.

Specifications of FTP

FTP protocol complies with RFC959 and handles the list of theoretical printer names as a transfer directory. File transfer to this directory executes print operation. Note that it is possible to specify ASCII (A) and BINARY (I) as transfer mode, and mode varies by the client.

The directory name is "lp".

- * Multiple sessions cannot be established at the same time.
- * Login users are as follows (without password)

root

anonymous

lp

Specifications of HTTP/HTTPS

This product is configurable by using Web browser.

URL is as follows (Recommended browser: Chrome)

1. Access to this product from Web browser at the following URL.

https://IP address of this product/

2. Click "Login" from WebConfig screen.

The screenshot displays the SATO WebConfig interface. At the top left is the SATO logo with the tagline "Ceaseless Creativity for a Sustainable World". The title "WebConfig" is centered at the top. On the top right, the model "SATO PW208NX" and resolution "203 dpi (8 dpmm)" are shown, along with a MAC address. A navigation menu includes "Dashboard", "Settings", "Tools", and "Certificates", with a "Login" button on the far right. The main content area is divided into several panels: "Printer Status" (Offline), "Printing" (Speed: 4 ips, DarknessRng: A, Darkness: 5, Sensor Type: 1-Mark, Print Mode: Tear-Off), "Device" (Model: PW208NX, Resolution: 203 dpi (8 dpmm), Serial Number, PCB Serial Number, Installed Options: Battery, Bluetooth, Dispenser, NFC, WLAN), "Network" (IPv4 Address, MAC Address), "System" (Firmware version, Uptime: 4min, Contact, Name, Location), and "Wi-Fi" (Mode: infra, SSID: regalia_dev, BSSID, Channel: 6 (2437 MHz)). A "Wi-Fi Strength" gauge shows a reading of -34 dBm. The footer contains the copyright notice "© SATO Corporation. All rights reserved. | http://www.satoworldwide.com".

3. Login.

Username: settings

Password: 0310

SATO WebConfig
Ceaseless Creativity for a Sustainable World

Model: SATO PW208NX
Resolution: 203 dpi (8 dpmm)
MAC Address: 94-23-3F-26-58-08

Dashboard Settings Tools Certificates **Login**

Printer Status
Offline

Network
IPv4 Address: 192.168.1.99
MAC Address: 94-23-3F-26-58-08

Wi-Fi Strength
-32 dBm

Printing
Speed: 4 ips
DarknessRng: A
Darkness: 5
Sensor Type: I-Mark
Print Mode: Tear-Off

Device
Model: PW208NX
Resolution: 203 dpi (8 dpmm)
Serial Number: 9C211458
PCB Serial Number: 79288947
Installed Options: Battery, Bluetooth, Dispenser, NFC, WLAN

Wi-Fi
Mode: infra
SSID: regalia_dev
BSSID: 94-23-3F-26-58-08
Channel: 6 (2437 MHz)

Login X

User:
settings

Password:

© SATO Corporation. All rights reserved. | <http://www.satoworldwide.com>

Login has been completed.

SATO WebConfig
Ceaseless Creativity for a Sustainable World

Model: SATO PW208NX
Resolution: 203 dpi (8 dpmm)
MAC Address: 94-23-3F-26-58-08

Dashboard Settings Tools Certificates **Logout**

Printer Status
Offline

Network
IPv4 Address: 192.168.1.99
MAC Address: 94-23-3F-26-58-08

Wi-Fi Strength
-30 dBm

Printing
Speed: 4 ips
DarknessRng: A
Darkness: 5
Sensor Type: I-Mark
Print Mode: Tear-Off

System
Firmware version: 3.0.0 (942625)
Uptime: 4min
Contact:
Name:
Location:

Device
Model: PW208NX
Resolution: 203 dpi (8 dpmm)
Serial Number: 9C211458
PCB Serial Number: 79288947
Installed Options: Battery, Bluetooth, Dispenser, NFC, WLAN

Wi-Fi
Mode: infra
SSID: regalia_dev
BSSID: 94-23-3F-26-58-08
Channel: 6 (2437 MHz)

© SATO Corporation. All rights reserved. | <http://www.satoworldwide.com>

Wireless LAN settings

802.1x authentication and certification

Depending on format, certification may be required or may not be required for 802.1x authentication. When certification is required, it is necessary to import it from Web setting screen or USB memory.

Following shows the necessity of certifications, ID and password of each format for 802.1 authentication followed by the types of certifications and secret keys.

■ Items to be imported from Web setting screen and USB memory

No.	Items to be imported	Description
1	Root certificate	File: Select a file of root certificate
2	Client certificate	Password: Enter secret password of client certificate File: File of client certificate
3	Secret key	Password: Enter password of secret key File: Select file of secret key
4	PAC file	Password: Enter password of PAC file File: Select PAC file.

■ Necessity of ID/Password, certifications of each format for 802.1x authentication

EAP format	Necessary information (○: Necessary, ×: Unnecessary)						
	User name	Password	Certification Password	Root certificate	Client certificate	Secret key	PAC file
EAP-TLS	○	×	○	○	○	○	×
EAP-PEAP	○	○	×	○*1	×	×	×
EAP-LEAP	○	○	×	×	×	×	×
EAP-TTLS	○	○	×	○*1	×	×	×
EAP-FAST	○	○	×	×	×	×	○

*1 Use client certificate instead of root certificate as long as it meets the conditions as described in supplementary explanation 2.

[Supplementary Explanation]

- Root certificate must fulfill the minimum requirements as follows.
 - Certification of computer in server shall be connected to reliable root certification authority (CA), the certification shall be run by CryptoAPI, and it should pass all tests being specified by remote access polity and network policy.
 - Computer certificates for NPS server and VPN server shall be configured as Extended Key Usage (EKU) is including server authentication in (Object ID for server authentication is 1.3.6.1.5.5.7.3.1.).
 - Server certification shall consist of required algorithm value RSA.
 - When SubjectAltName-extension is used, DNS name of server shall be included to this SubjectAltName-extension.

- Server accepts Certification attempts by client if the server meets the following requirements when using EAP-PEAP and EAP-TTLS. (For Windows Server 2008/2008R2/2012/2012R2)
 - Client certificate shall be issued by Enterprise CA or it shall be mapped to account of user or computer in Active Directory[®] domain service (AD DS).
 - There shall be certification chain for certification of user and computer of client and the certification chain shall be used for reliable root CA. EKU extension shall aim for client certificate (Object identifier of client certificate is 1.3.6.1.5.5.7.3.2). In addition, those certifications shall pass the check test run with CryptoAPI and specified by remote access policy and/or network policy, and also those certifications shall pass the check test on certificate object identifier specified by IAS remote access policy and/or NPS network policy.
 - 802.1x client shall not use any of registry based certificates such as Smart Card Logon Certificate or password protected certificate.
 - SubjectAltName-extension of certificate shall include Fully Qualified Domain Name (FQND) (DNS name) for computer certificate.

Socket communication

With functionality of TCP/IP Socket server, it is possible to use 2 port connection in where Port 1 is used for receiving status 4 supported print data and Port 2 is used for returning printer status. Also it is possible to use 1 port connection in where Port 1 or Port 3 is used for receiving status 3/status 4 supported print data and returning printer status.

When Port 3 is used, only status return data and printer operation setting request data are returned to host.

It is not possible to use 2 port connection and 1 port connection at the same time.

It is not possible to have few sessions connected at once to each Socket.

Besides Socket, it is possible to use LPR and FTP for sending print data. It is not allowed to connect to print data port (Port 1 or Port 3) while LPR and/or FTP is connected due to Socket communication.

Please do not use 2 ports connections consist of Port 2 port and Port 3 port.

1. Print by 2 port connection/Socket (Status 4)

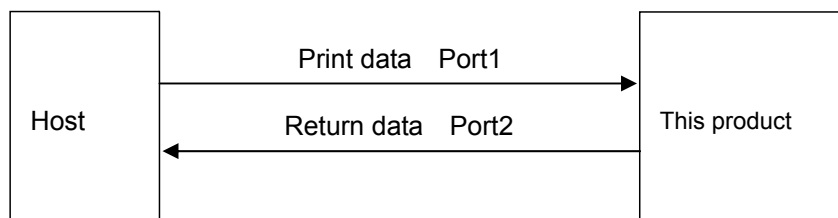

2. Print by 1 port connection/Socket (Status 4)

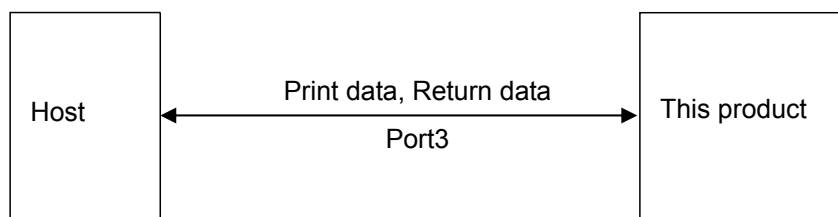

3. Print by 1 port connection/Socket (Return status 3)

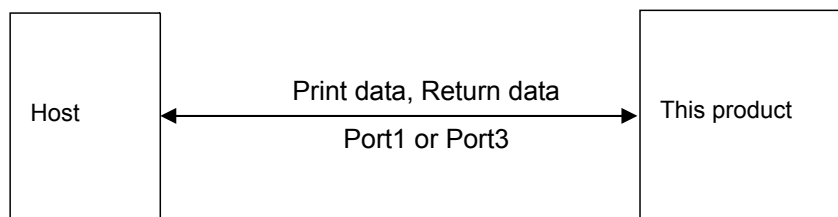

4. Print with LPR and FTP

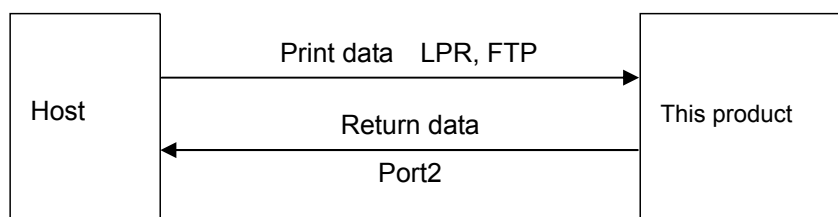

Connection and Disconnection of session

Socket server functionality performs connection and disconnection of print data port (Port1), Status return port (Port2), Sent/Received port (Port3 or Port 3) as follows.

Status 4

1) Print data port (Port1), Status return port (Port2)

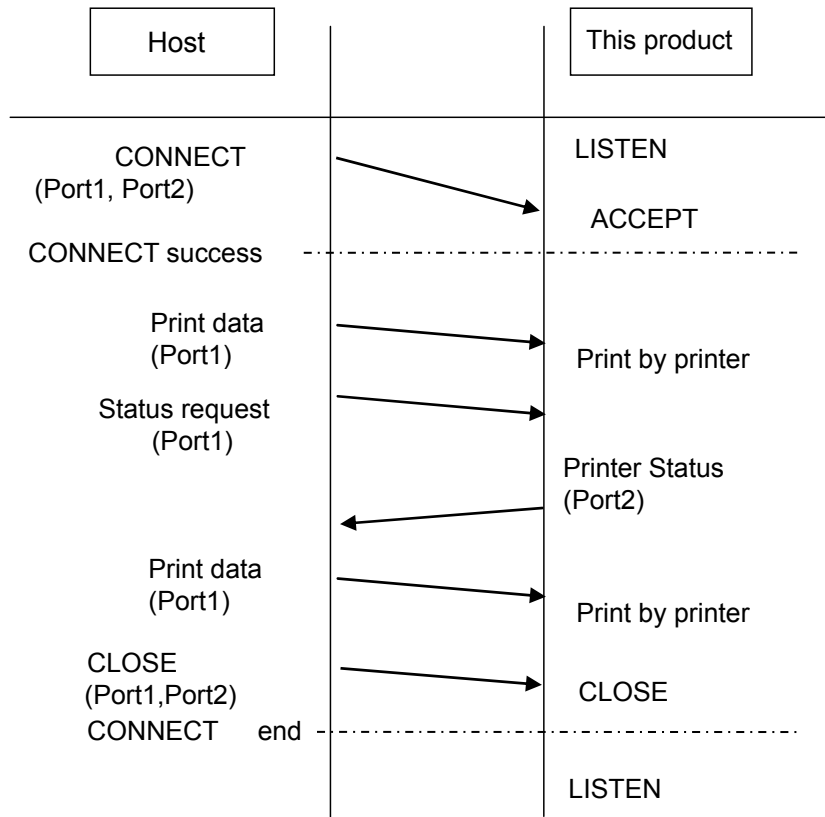

Status 3/Status 4

2) Sent/Received port (Port3 or Port1)

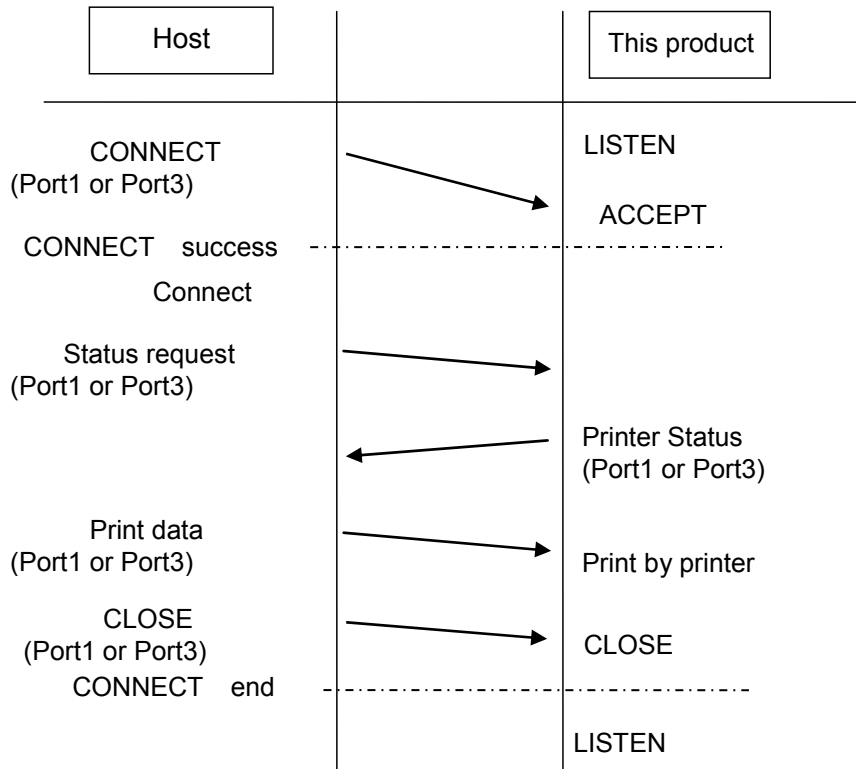

Printer Status

1) Status mode

There are two types of mode for status return when using Wireless LAN interface.

1. Status4/ENQ response mode (2 ports connection or 1 port connection)

Port 1 is used for print data port, Port 2 is used for status return, Port 3 is used for print data port and status return.

Printer Status is returned when printer receives status request command from host.

2. Status 3/ENQ response mode (1 port connection)

Port 1 is used for both print data port and status return port. Port 3 is used for both print data port and status return port.

ACK is returned when printer receives print request command from host, and Printer Status is returned when printer receives status request command from host.

It is not possible to print label by using printer driver when Status 3 is in use.

Status modes are switched by changing the setting of communication protocol and timing of Printer Status return in communication setting mode of this product. Following chart shows the relationship between the types of status mode, setting items of communication setting mode.

Type of status mode	Setting item of communication setting mode	
	Communication protocol (PROTOCOL)	Timing of Printer Status return (REPLY TIMING)
2 ports connection ENQ response mode	STATUS4	ENQ
1 port connection ENQ response mode	STATUS3	ENQ

2) Data format of Status Return

1. 2 ports connection (Status 4 return)

Number of byte to send 4 bytes 0000001CH	ENQ 1 byte 05H	STX 1 byte 02H	ID number 2 bytes	Status 1 byte	Remaining labels 6 bytes	JOB name 16 bytes	ETX 1 byte 03H
--	----------------------	----------------------	-------------------------	------------------	--------------------------------	-------------------------	----------------------

(Total 32 bytes)

Please refer to [Return status of Status 4] for the description of [Status].

2. 1 port connection (Status 3 return)

STX 1 byte 02H	ID number 2 bytes	Status 1 byte	Remaining labels 6 bytes	ETX 1byte 03H
----------------------	-------------------------	------------------	--------------------------------	---------------------

(Total 11 bytes)

Please refer to [Return status of Status 3] for the description of [Status].

3) Sequence

1. Status 4/ENQ response mode (2 port connection or 1 port connection)

The latest Printer Status is returned after printer receives status request command (ENQ:05H) from host.

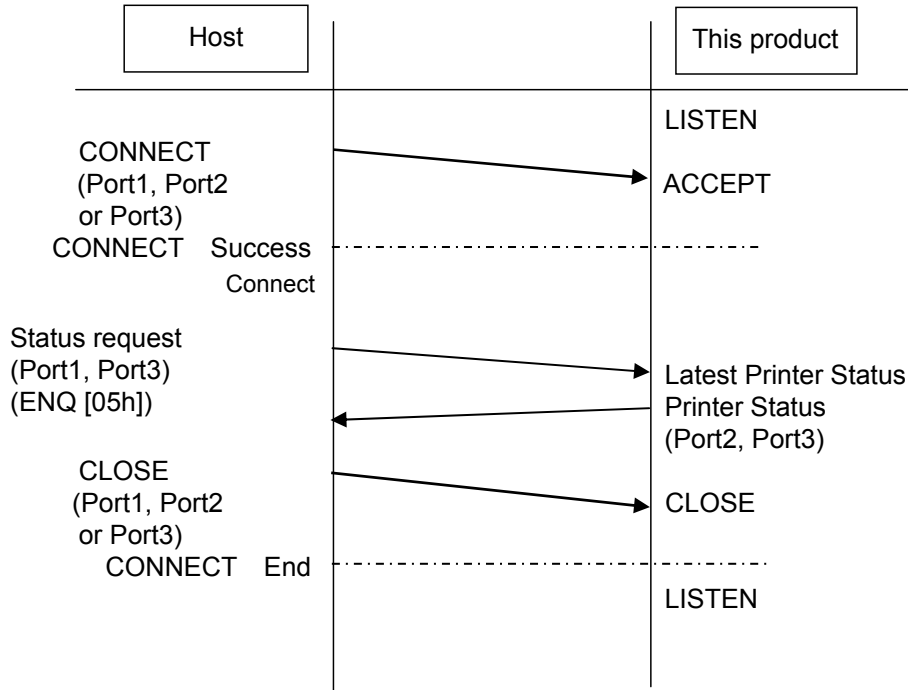

2. Status 3/ENQ response mode (1 port connection)

This product sends ACK after receiving print request command from host and sends Printer Status after receiving status request command (ENQ:05H) from host.

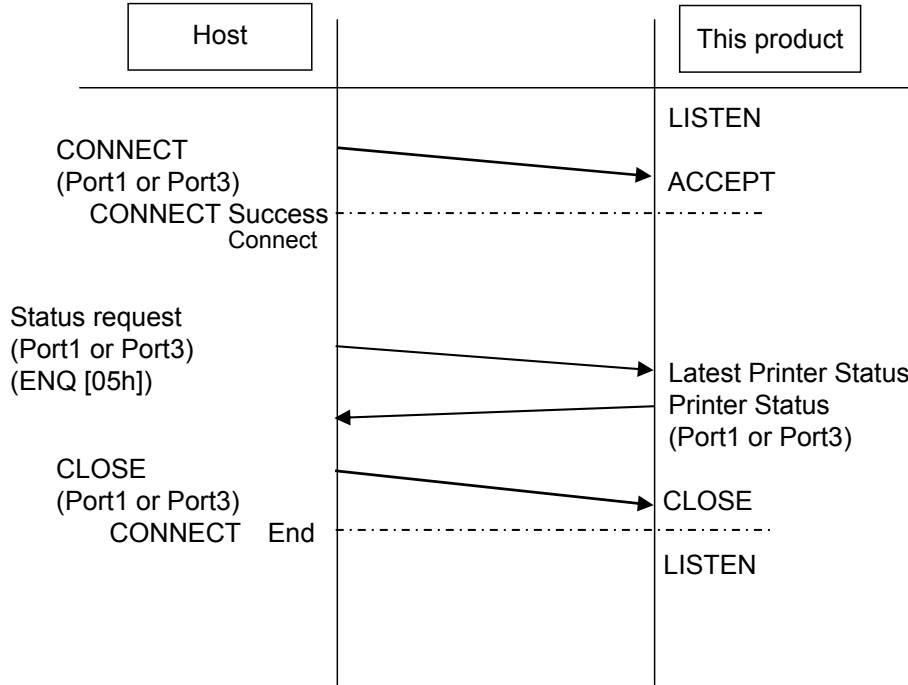

Specification of SNMP

SNMP is a protocol to monitor and control network devices connected to network.

This product supports communication with SNMPv1, SNMPv2c, SNMPv3, and MIB supports following MIB-II. With this MIB, it is possible to acquire information, to send notification on administrative information, and to change settings.

- system(1)
- interface(2)
- at(3)
- ip(4)
- icmp(5)
- tcp(6)
- udp(7)
- snmp(10)
- host(25)
- printerMIB(43)

HostResourceMIB/prinerMIB is used for showing the status of this product. Please refer to the next page for the details.

PrinterMIB / HostResourceMIB to show the status of printer

PW208NX/PW208mNX			Trap	Printer MIB				Host Resources MIB		
#	Alert	Description		prtAlertSeverityLevel	prtAlertTrainingLevel	prtAlertGroup	prtAlertCode	hrPrinterDetectedErrorState	hrDeviceStatus	hrPrinterStatus
1	EBATTDEG	Battery degradation	X	critical(3)	untrained(3)	other(1)	subunitLifeOver(11)	-	Depends on the printer status (mStatus_XXX) / (mStatus_XXX)	Depends on the printer status (mStatus_XXX) / (mStatus_XXX)
2	EBATTCAUTION	Battery degradation	X	critical(3)	untrained(3)	other(1)	subunitLifeOver(11)	-		
3	EBATTERY	Battery error	X	critical(3)	untrained(3)	other(1)	subunitUnrecoverableFailure(30)	-		
4	EBATTLOW	Battery low	X	critical(3)	untrained(3)	other(1)	subunitAlmostEmpty(12)	-		
5	EBATTLOWCHG	Battery low (charging)	X	critical(3)	untrained(3)	other(1)	subunitAlmostEmpty(12)	-		
6	EBATTNONE	No battery	X	critical(3)	untrained(3)	other(1)	subunitMissing(9)	-		
7	EBATTTEMP	Battery temperature error	X	critical(3)	other(1)	other(1)	subunitAtLimit(17)	-		
8	EBATTWARNING	Battery degradation	X	critical(3)	other(1)	other(1)	subunitLifeOver(11)	-		
9	EBOVER	Buffer overflow	X	critical(3)	other(1)	channel(14)	other(1)	-		
10	EBTMODULE	Bluetooth module error	X	critical(3)	fieldService(5)	channel(14)	subunitUnrecoverableFailure(30)	-		
11	ECHARGEPOWFF	Charging	X	critical(3)	untrained(3)	other(1)	other(1)	-		
12	ECMD/ECOMMAND	SBPL command error	X	critical(3)	other(1)	interpreter(15)	other(1)	-		
13	ECOPY_SRCISDST	Destination is source	X	critical(3)	other(1)	interpreter(15)	other(1)	-		
14	ECOVEROPEN	Cover open	X	critical(3)	untrained(3)	cover(6)	coverOpen(3)	bit #4 (doorOpen)		
15	ECRC	CRC error	X	critical(3)	other(1)	channel(14)	other(1)	-		
16	EDENSITY	Head density change	X	critical(3)	fieldService(5)	marker(10)	other(1)	-		
17	EDIGEST	Package verification error	X	critical(3)	other(1)	other(1)	other(1)	-		
18	EEAPAUTH	EAP authentication error	X	critical(3)	trained(4)	channel(14)	other(1)	-		
19	EEAPTIME	EAP authentication error	X	critical(3)	trained(4)	channel(14)	other(1)	-		
20	EFRAM	Framing error	X	critical(3)	other(1)	channel(14)	other(1)	-		
21	EGAPTOOLONG	Gap too long	X	critical(3)	untrained(3)	input(8)	other(1)	-		

PW208NX/PW208mNX			Trap	Printer MIB				Host Resources MIB		
#	Alert	Description		prtAlertSeverityLevel	prtAlertTrainingLevel	prtAlertGroup	prtAlertCode	hrPrinterDetectedErrorState	hrDeviceStatus	hrPrinterStatus
22	EHDERR/EHEAD	Head error	X	critical(3)	fieldService(5)	marker(10)	other(1)	-		
23	EHOPEN/EHEADOPEN	Head open	X	critical(3)	untrained(3)	marker(10)	subunitOpened(18)	bit #4 (doorOpen)		
24	ELAN	LAN error	X	critical(3)	other(1)	channel(14)	other(1)	-		
25	EMACHINE	Machine error	X	critical(3)	fieldService(5)	other(1)	other(1)	-		
26	EMEDIA	Media error	X	critical(3)	trained(4)	other(1)	other(1)	-		
27	ENFCCMDERROR	NFC command error	X	critical(3)	other(1)	other(1)	other(1)	-		
28	ENFCMODULE	NFC module error	X	critical(3)	fieldService(5)	other(1)	other(1)	-		
29	EMOTERTEMP	Motor overheated	X	critical(3)	other(1)	other(1)	subunitOverTemperature(36)	-		
30	ENOGAP	Gap not found	X	critical(3)	untrained(3)	input(8)	other(1)	-		
31	ENOIMARK	I-mark not found	X	critical(3)	untrained(3)	input(8)	other(1)	-		
32	ENOTFOUND	Not found	X	critical(3)	other(1)	other(1)	other(1)	-		
33	ENOTHINGTOPRINT	No fields to print	X	critical(3)	untrained(3)	interpreter(15)	other(1)	-		
34	EOPTION	Option error		critical(3)	fieldService(5)	other(1)	other(1)	-		
35	EORUN	Overrun error	X	critical(3)	other(1)	channel(14)	other(1)	-		
36	EOVERHEAT	Print head overheated	X	critical(3)	other(1)	marker(10)	subunitOverTemperature(36)	-		
37	EPAPERJAM	Paper jam	X	critical(3)	trained(4)	mediaPath(13)	jam(8)	bit #5 (jammed)		
38	EPARAM	Invalid argument	X	critical(3)	other(1)	other(1)	other(1)	-		
39	EPEND/ENOPAPER	Out of paper	X	critical(3)	untrained(3)	input(8)	inputMediaSupplyEmpty(808)	bit #1 (noPaper)		
40	EPLATFORM	Package platform mismatch error	X	critical(3)	other(1)	other(1)	other(1)	-		
41	EPOWEROFF	Power off error	X	critical(3)	trained(4)	other(1)	other(1)	-		
42	EPRINTERTEMP	Printer overheated	X	critical(3)	fieldService(5)	generalPrinter(5)	subunitOverTemperature(36)	-		
43	EPROGRAM	Program error	X	critical(3)	fieldService(5)	other(1)	other(1)	-		
44	EPRTY	Parity error	X	critical(3)	other(1)	channel(14)	other(1)	-		
45	ERAMDISK	Ramdisk not found error	X	critical(3)	other(1)	other(1)	other(1)	-		
46	EREINDEX	Database reindex error	X	critical(3)	other(1)	interpreter(15)	other(1)	-		
47	ESDBCFSIZE	Too many bytes in indexed column	X	critical(3)	other(1)	interpreter(15)	other(1)	-		

PW208NX/PW208mNX			Trap	Printer MIB				Host Resources MIB		
#	Alert	Description		prtAlertSeverityLevel	prtAlertTrainingLevel	prtAlertGroup	prtAlertCode	hrPrinterDetectedErrorState	hrDeviceStatus	hrPrinterStatus
48	ESDBCONN	Not connected to table	X	critical(3)	other(1)	interpreter(15)	other(1)	-		
49	ESDBCONTEXT	Edit operation not allowed	X	critical(3)	other(1)	interpreter(15)	other(1)	-		
50	ESDBNOISPC	No space in table index	X	critical(3)	other(1)	interpreter(15)	other(1)	-		
51	ESDBBROWSIZE	Too many bytes in sdb row	X	critical(3)	other(1)	interpreter(15)	other(1)	-		
52	ESENSER	Sensor error	X	critical(3)	trained(4)	mediaPath(13)	jam(8)	bit #5 (jammed)		
53	ESIGNFILE	No RSA key found	X	critical(3)	other(1)	other(1)	other(1)	-		
54	ESIGNFILEM	No matching RSA key found	X	critical(3)	other(1)	other(1)	other(1)	-		
55	ESIPLFIELDFULL	Field full	X	critical(3)	other(1)	interpreter(15)	other(1)	-		
56	ESIPLFORMATFULL	Format full	X	critical(3)	other(1)	interpreter(15)	other(1)	-		
57	ESNTP	NTP error	X	critical(3)	other(1)	other(1)	other(1)	-		
58	ESOCKET	Socket error	X	critical(3)	fieldService(5)	channel(14)	other(1)	-		
59	ESTALEID	Status for job id has been recycled	X	critical(3)	other(1)	interpreter(15)	other(1)	-		
60	EVERSIONGT	Operation requires a later version	X	critical(3)	other(1)	other(1)	other(1)	-		
61	EVERSIONLT	Operation requires a previous version	X	critical(3)	other(1)	other(1)	other(1)	-		
62	EWLANMODULE	WLAN module error	X	critical(3)	fieldService(5)	channel(14)	other(1)	-		
63	EXMLSCHEMA	XML XSD error	X	critical(3)	other(1)	interpreter(15)	other(1)	-		
64	guiWarning_changeBattery1	Change battery	X	warning(4)	untrained(3)	other(1)	subunitLifeAlmostOver(10)	-		
65	guiWarning_changeBattery2	Change battery	X	warning(4)	untrained(3)	other(1)	subunitLifeAlmostOver(10)	-		
66	guiWarning_changePlaten	Change platen	X	warning(4)	fieldService(5)	mediaPath(13)	subunitLifeAlmostOver(10)	-		
67	guiWarning_changeTPH	Change TPH	X	warning(4)	fieldService(5)	marker(10)	subunitLifeAlmostOver(10)	-		
68	guiWarning_cleanHead	Clean head	X	warning(4)	trained(4)	marker(10)	other(1)	-		
69	guiWarning_commandError	Command error	X	warning(4)	other(1)	interpreter(15)	other(1)	-		
70	guiWarning_headError	Head error	X	warning(4)	fieldService(5)	marker(10)	other(1)	-		
71	guiWarning_paperNearEnd	Paper near end	X	warning(4)	untrained(3)	input(8)	inputMediaSupplyLow(807)	bit #0 (lowPaper)		
72	guiWarning_receiveBufferNearFull	Receive buffer near full	X	warning(4)	other(1)	channel(14)	other(1)	-		

PW208NX/PW208mNX			Trap	Printer MIB				Host Resources MIB		
#	Alert	Description		prtAlertSeverityLevel	prtAlertTrainingLevel	prtAlertGroup	prtAlertCode	hrPrinterDetectedErrorState	hrDeviceStatus	hrPrinterStatus
73	guiWarning_unknownHead	Unknown head	X	warning(4)	fieldService(5)	marker(10)	other(1)	-		
74	mStatus_error	Offline and error	X	critical(3)	untrained(3)	generalPrinter(5)	subunitOffline(22)	bit #6 (offline) bit #7 (serviceRequested)	down(5)	other(1)
75	mStatus_online mStatus_aep	Online	-	-	-	-	-	-	running(2) / warning(3) *	idle(3) / printing(4) **
76	mStatus_offline	Offline	X	critical(3)	untrained(3)	generalPrinter(5)	subunitOffline(22)	bit #6 (offline)	down(5)	other(1)
77	mStatus_powerDown	Power down	-	-	-	-	-	-	down(5)	other(1)
78	mStatus_init	Initializing	-	-	-	-	-	-	down(5)	warmup(5)
79	mStatus_upgrading	Upgrading	-	-	-	-	-	-	down(5)	other(1)
80	mStatus_powersave	Power Saving Mode	-	-	-	-	-	-	running(2) warning(3) down(5) ***	other(1)
81	mStatus_wakeup	Waking up from Power Saving Mode	-	-	-	-	-	-	running(2) warning(3) down(5) ***	warmup(5)

* warning(3) is set in the case of an active warning (guiWarning_XXX), else running(2) is set./warning

** printing(4) is set while printing a label, else idle(3) is set.

*** running(2) or warning(3) is set (see *) if the printer will wake up to the online state (mStatus_online), else down(5) is set.

Notes

- 150 ms to 200 ms interval is required to close port then open port, if you want to open and close print data port (Port 1), Status port (Port 2) and send/received port (Port 3). Short interval setting may cause double connection. Request for double connection occurs when [CONNECT] request is made to Port (Port1, Port2 or Port3) in addition to the request [CONNECT (Socket OPEN)] which has already been made to Port (Port1, Port2 or Port3). When printer receives request for double connection, it sends response of Disconnection (Socket CLOSE) to the request.
- Communication distance and transmission rate between host and printer (Wireless LAN board) varies by operating environment due to operating conditions of Wireless LAN.
- It is recommended to use it in Infrastructure mode on the condition that display of field intensity of Wireless LAN is level3 or above (following chart).



- It is likely that communication data is lost if environment of Wireless LAN is not appropriate because Wireless LAN is portable or due to ambient conditions.
- Please set frequency of channel for each group to every [5 channel] or more than 5 channels if you want to place few Wireless LAN network groups next to each other.

Ex) When channel of group1 is [1], channel of group 2 shall be set to [6] channel or after.

Bluetooth

Bluetooth interface of this printer complies with Bluetooth Ver. 3.0 standard.

Basic specification

Standard

Bluetooth Ver. 3.0+EDR Power Class 2

Communication distance

10 m (Prescribed measurement environment)

Profile for use

Serial Port Profile (SPP)

SPP defines connection of two Bluetooth supported devices by establishing virtual serial port.

Operation mode

Slave mode

Authentication level

Level 1: No authentication

Level 2-1: PIN code authentication, Service level, No encryption

Level 2-2: PIN code authentication, Service level, Encryption

Level 3: PIN code authentication, Service level, No encryption

Level 4: Support for secure simple pairing, Service level, Encryption

Initial value: No authentication

PIN code

ASCII code in 1 to 16 digits (20H,21H,23H to 7EH)

Initial value: 0000

Device name

ASCII code in 0 to 53 digits (20H,21H,23H to 7EH)

Initial value: SATO PRINTER_XXXXXXXXXX (XXXXXXXXXX is BD address)

Power saving mode

sniff, park, hold (Operate according to host setting)

Setting of CRC (Enabled/Disabled)

CRC: Enabled/Disabled

Initial value: Disabled

Disconnection timeout period (SPP layer)

0 second (Initial value)

Disconnection timeout period (LMP layer)

60 seconds (Initial value)

Parameter

Setting item	Setting range
Protocol	Status 3 Status 4 (Initial value) None

Receive buffer size

2.95 MB

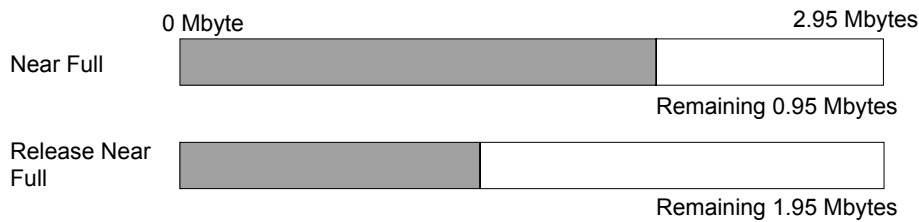

Pairing

Keep link keys for 10 devices

CoD (Class of Device)

Major service class: Unspecified

Major device class: Imaging major class

Minor device class: Printer

supervision timeout

Initial value=20 seconds (Changeable from host)

[Supplementary Explanation]

- Printer operates in slave mode. Before establishing connection, specify Bluetooth Device address (BD address) from the master.
- Connection may not be established when master's authentication mode, packet type, and PIN code are different from above setting. In that case, confirm authentication level and PIN code by [Tools] menu > [Test Print] > [Configure List] in [Settings] menu, match with master setting and try reconnection.
- Bluetooth interface and printer is connected by internal serial interface.
- When Bluetooth LINK is lost (e.g. out of service area), disconnects from the printer after supervision timeout period has passed. Supervision timeout period is monitoring time of physical link layer.
- When Bluetooth communication is disconnected while sending print data (STX<A> to <Z>ETX), the received data is discarded after disconnection time-out period has passed. It is required to resend print data (STX<A> to <Z>ETX) when time out occurs. Time out is not monitored if disconnection time out period is set to 0.

- Buffer over occurs if printer has full of receive buffer. Please send ENQ then send print data as checking the status of receive buffer.
- ACK/NAK is returned when CRC check result is normal and CRC check is valid.

Bluetooth settings

Following items are available for Bluetooth interface setting.

(1) Authentication level (Level1, Level2-1, Level 2-2, Level 3, Level 4)

(2) PIN code (Alphanumeric character and codes (20H, 21H, 23H to 7EH) 1 to 16 digits)

PIN code (Personal Identification Number, Pass-key) consists of 1 to 16 codes and is an authentication password to be used for identifying printer. This PIN code is required for authentication level 2 to 4. When pairing starts in printer after authentication with PIN code, link key will be automatically generated. Once link key is generated, it is no longer necessary to perform authentication with PIN code so that it is possible to establish connection during pairing without confirmation of PIN code.

Bluetooth specification Ver 3.0 module supports FastConnect. Information on pairing for 10 devices is saved under printer. When pairing is performed for 10 devices or more, printer will delete the oldest information on pairing then will save the information on pairing of new connected device. (Information on pairing will not be cleared by Factory Clear)

(3) Communication parameter (ISI, ISW, PSI, PSW)

Bluetooth module has setting values of ISI, ISW, PSI, PSW, and the details are described in the list below.

Setting	Description
ISI (Inquiry Scan Interval)	ISW time interval (0,18 to 4096) (every 0.625 ms)
ISW (Inquiry Scan Window)	Response time for search request from the host (0,17 to 4096) (every 0.625 ms)
PSI (Page Scan Interval)	PSW time interval (18 to 4096) (every 0.625 ms)
PSW (Page Scan Window)	Response time for connection request from the host (17 to 4096) (every 0.625 ms)

- When ISI=0 and ISW=0, device search from master device can be rejected.
- Initial values of factory clear are ISI=2048 (1.28 sec), ISW=18 (11.25 ms), PSI=144 (90 ms), and PSW=18 (11.25 ms).
- It is prohibited to set as ISI<ISW nor PSI<PSW.
- Normally communication parameter does not need to be changed. However it needs to be adjusted when the radio wave signals are low.

(4) Device name (Alphanumeric number and codes (20H, 21H, 23H to 7EH) 1 to 20 digits)

Any device name can be set and displayed on connected device to identify the printer.

Note:

Initialized communication parameter is set to Bluetooth interface as turning on the power of printer for the first time after it was set. Do not turn off the power of printer until printer is booted normally for reboot.

CRC transmission data

When CRC check mode is selected, transmit data format needs to be configured as follows.

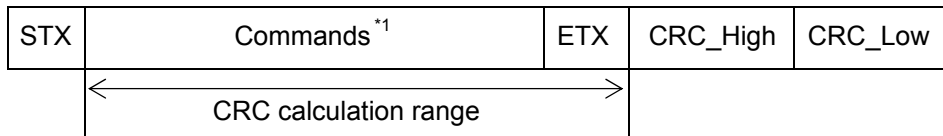

Item	HEX (H)	Description
STX	02	Transmission control character to start text
Commands	-	Commands+Parameter
ETX	03	Transmission control character to end text
CRC	2 bytes	Calculate by computation method called CRC-ANSI. Sends High first then Low with error control value calculated by CRC-16(generating polynomial $X^{16}+X^{15}+X^2+1^{*2}$)

- Start of Data Transmission <A> and End of Data Transmission <Z> shall be set to the command.

STX and ETX must to be set in transmission data when CRC is enabled. When printer cannot receive STX or ETX, print operation is not executed.

- Since it is a right shift, the actual value used for calculation will be 0xA001. Initial value is 0.

CRC calculation data

Following shows a part of CRC calculation process when sending print speed <CS> as an example.

Transmission data is STX <A> <CS>2 <Z> ETX, and this will be "02 1B 41 1B 43 53 32 1B 5A 03" in HEX. The underlined area is CRC calculation range. Generating polynomial is expressed "1010 0000 0000 0001" as binary numbers. 1B is the first object of calculation and it is expressed "0001 1011" as binary numbers. Initial value of CRC is "0".

(1) CRC = CRC XOR Object data(1B)	<pre> 0000 0000 0000 0000 (CRC) XOR) 0000 0000 0001 1011 (1B) ----- CRC = 0000 0000 0001 1011 A = 1 CRC = 0000 0000 0000 1101 </pre>
(1-1) A=CRC AND "0001" CRC= shift 1bit right of CRC	
(1-1) If A=1, CRC XOR Generating polynomial, and assign the result to CRC. If A=0, do nothing	<pre> 0000 0000 0000 1101 (CRC) XOR) 1010 0000 0000 0001 (Polynomial) ----- CRC = 1010 0000 0000 1100 </pre>
(2-1) Calculate the same as (1-1), and repeat (1-1) and (1-2) calculation seven times. (8bits in total)	<pre> A = 0 CRC = 0101 0000 0000 0110 </pre>
(2-2) Calculate the same as (1-2). CRC is as it is since A=0.	<pre> CRC = 0101 0000 0000 0110 </pre>
(3-1) Calculation the same as (1-1).	<pre> A = 0 CRC = 0010 1000 0000 0011 </pre>
(3-2) Calculate the same as (1-2).	<pre> CRC = 0010 1000 0000 0011 </pre>
(4-1) Calculation the same as (1-1).	<pre> A = 1 CRC = 0001 0100 0000 0001 </pre>
(4-2) Calculate the same as (1-2).	<pre> 0001 0100 0000 0001 (CRC) XOR) 1010 0000 0000 0001 (Polynomial) ----- CRC = 1011 0100 0000 0000 </pre>
(5-1) Calculate the same as (1-1).	<pre> A = 0 CRC = 0101 1010 0000 0000 </pre>
(5-2) Calculate the same as (1-2).	<pre> CRC = 0101 1010 0000 0000 </pre>
(6-1) Calculate the same as (1-1).	<pre> A = 0 CRC = 0010 1101 0000 0000 </pre>
(6-2) Calculate the same as (1-2).	<pre> CRC = 0010 1101 0000 0000 </pre>
(7-1) Calculate the same as (1-1).	<pre> A = 0 CRC = 0001 0110 1000 0000 </pre>
(7-2) Calculate the same as (1-2).	<pre> CRC = 0001 0110 1000 0000 </pre>
(8-1) Calculate the same as (1-1).	<pre> A = 0 CRC = 0000 1011 0100 0000 </pre>
(8-2) Calculate the same as (1-2).	<pre> CRC = 0000 1011 0100 0000 </pre>
CRC calculation for "1B" is completed. Repeat the same calculation of (1) for next object data "41" until "03". In this case EC 5E.	<pre> Calculation result until 03 CRC = 1110 1100 0101 1110 </pre>

Example of transmission data

Following shows an example of transmission data.

(1) Print data

STX
<A>
<X22>,sato
<Q>0001
<Z>
ETX
71H 9CH

Following shows HEX data to be sent. CRC is shown with underline.

02 1B 41 1B 58 32 32 2C 53 41 54 4F 1B 51 30 30 30 31 1B 5A 03 71 9C

(2) Print speed Command <CS>

STX
<A>
<CS>2
<Z>
ETX
ECH 5EH

Following shows HEX data to be sent. CRC is shown with underline.

02 1B 41 1B 43 53 32 1B 5A 03 EC 5E

CRC error display

The printer checks the validity of receive data by calculating CRC for each received item and comparing it with the received CRC. The receive data is proven to be invalid if both CRC does not match, then it stops printing by generating the "CRC error" at the point when this item starts printing.

There are two ways to clear CRC error as follows.

1. Hold down [Feed/Select] key
Resumes printing from the print data with CRC error.
2. Hold down [Print/Select] key
Clears print data with CRC error and resume printing from next item

[Supplementary Explanation]

- Return status of Status3, 4 at the time of CRC error will be [Other errors].

Transmission sequence

Normal end

Status 4 (CRC check is enabled)

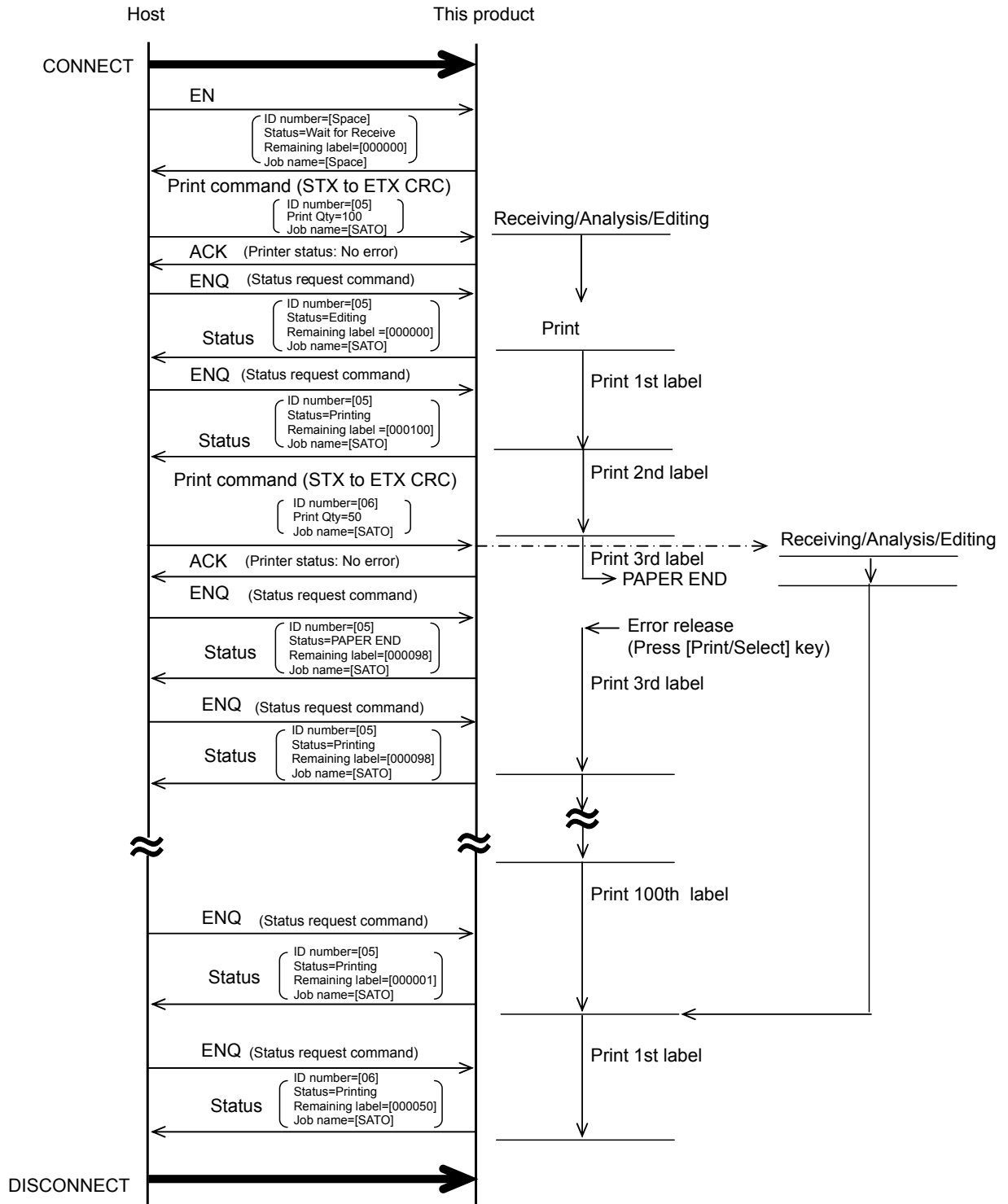

Status 3 (CRC check is enabled)

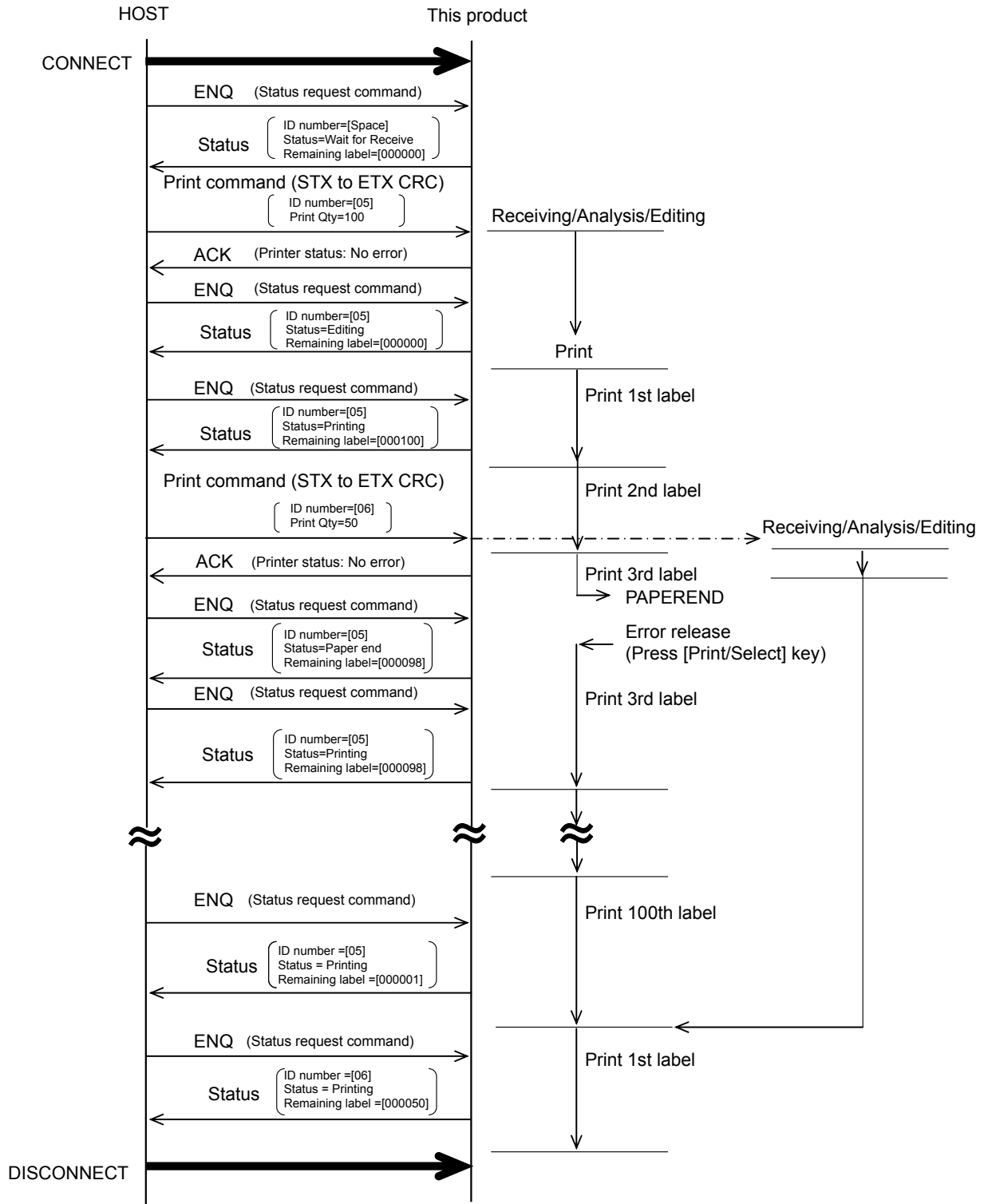

Status 4 (CRC check is disabled)

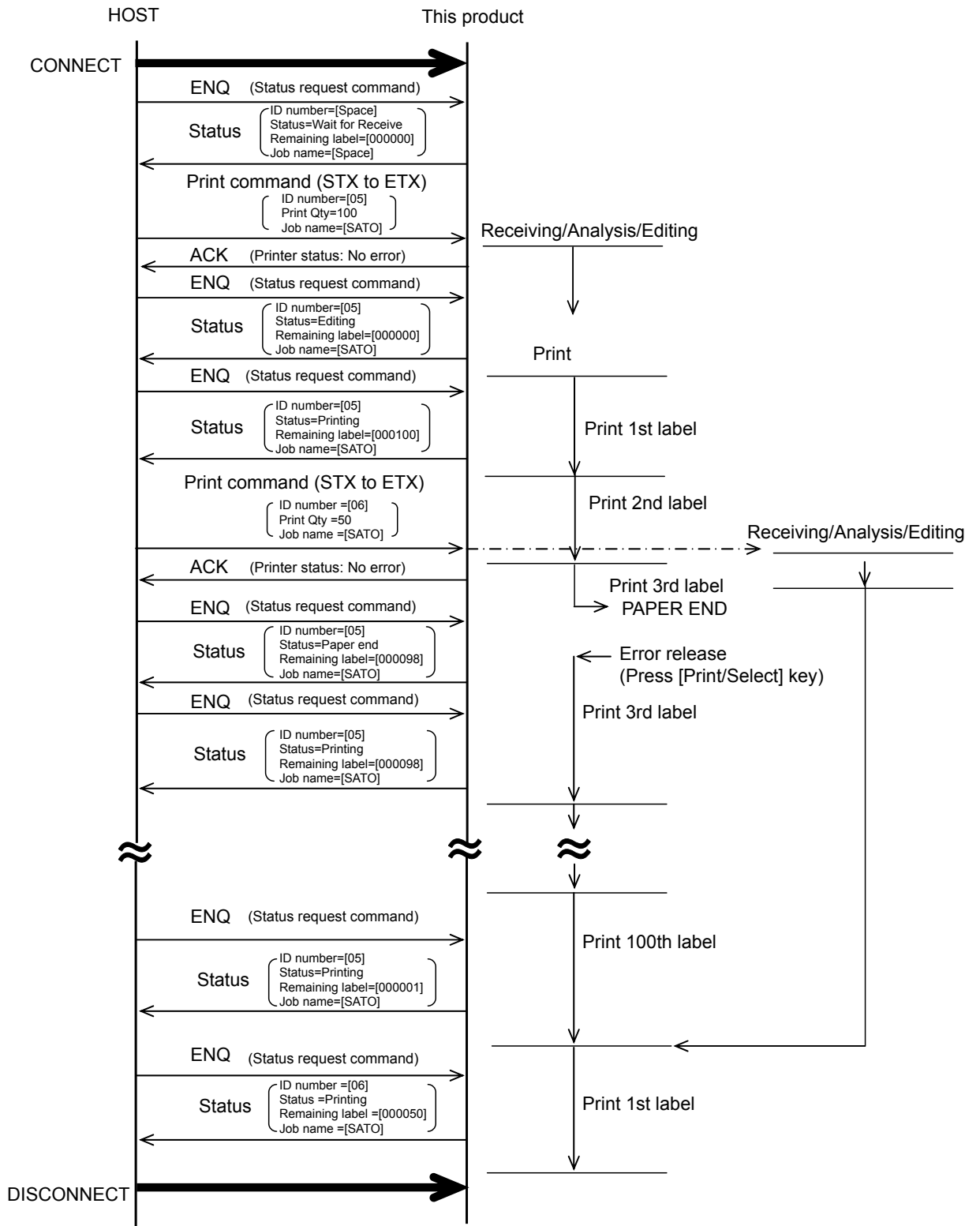

Status 3 (CRC check is disabled)

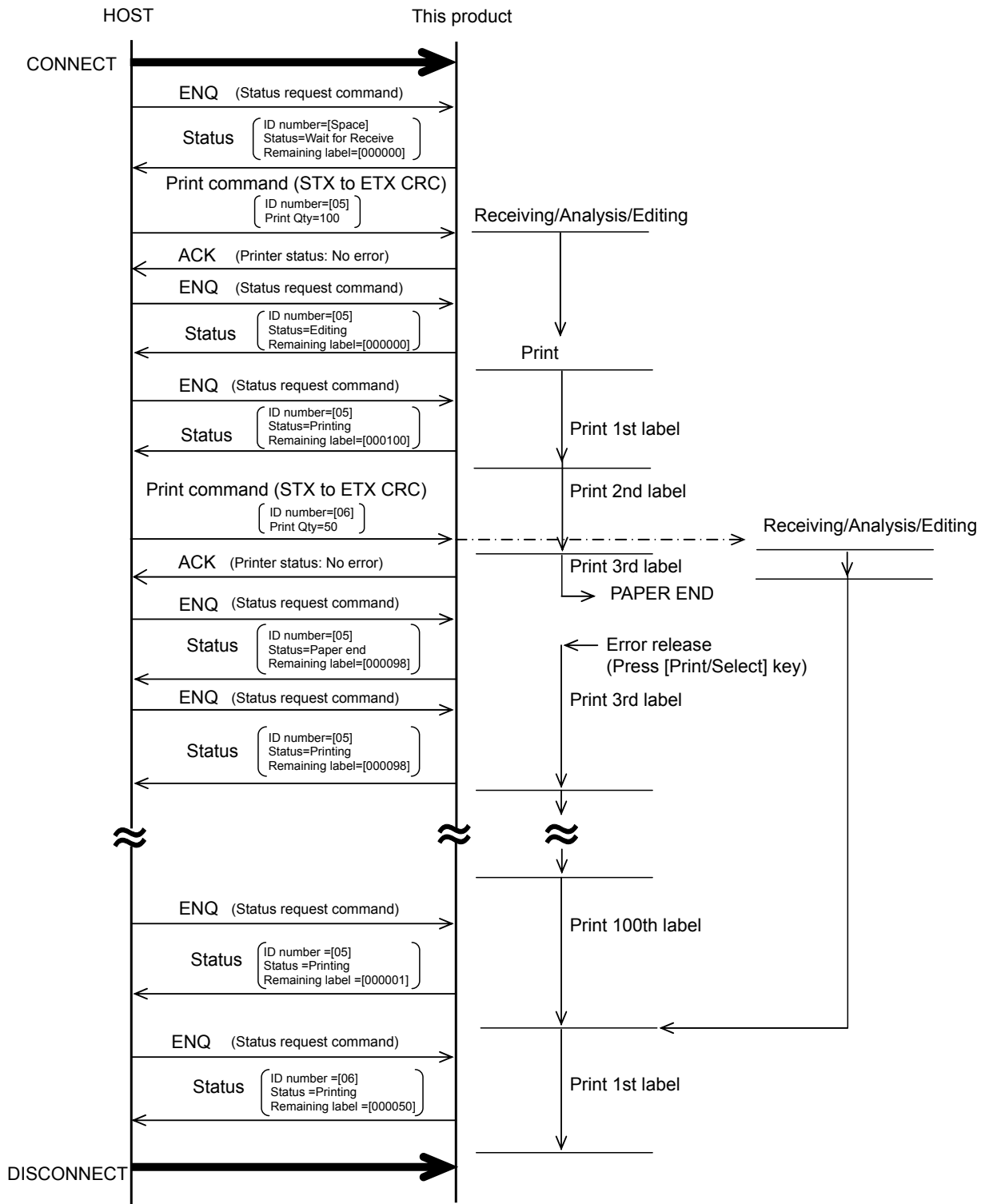

In case where communication is lost while transferring print data

Note

- The print data cannot be guaranteed if communication through Bluetooth is disconnected while sending print data.

Make sure to turn off the power of printer, then turn on it again to retransmit the print data.

CRC check is enabled (Common in status 3 and 4)

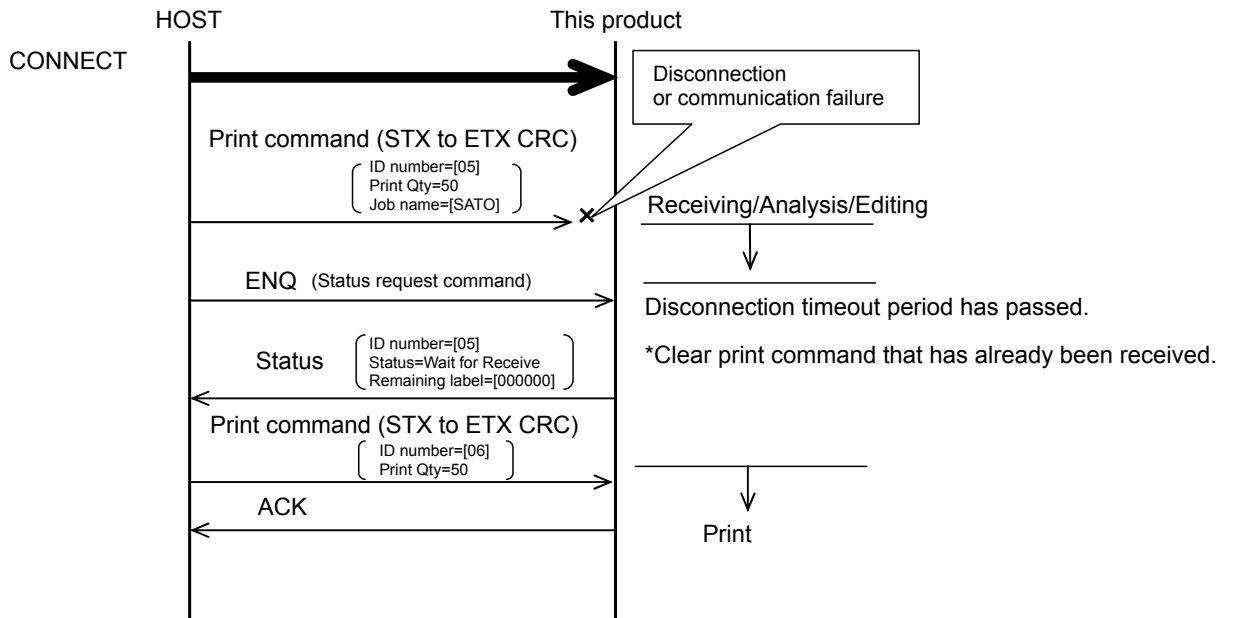

Note

- In case where communication through Bluetooth is disconnected while transmitting print data, print data that has already been received, will be cleared after disconnection timeout period.

CRC check is disabled (Common in status 3 and status 4)

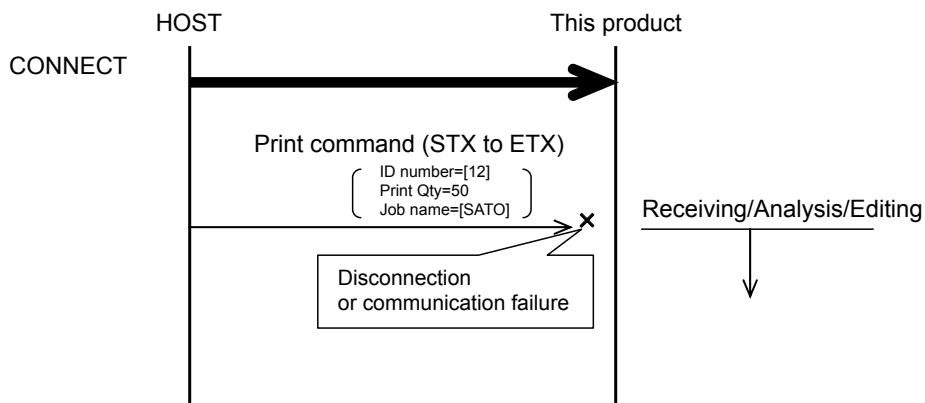

Note

- Print data cannot be guaranteed if communication through Bluetooth is disconnected while sending print data as in the figure above. Please resend print data after turning off the power of printer then on it again.

In case where communication is lost while transferring status after receiving print data

CRC check is enabled (Common in status 3 and status 4)

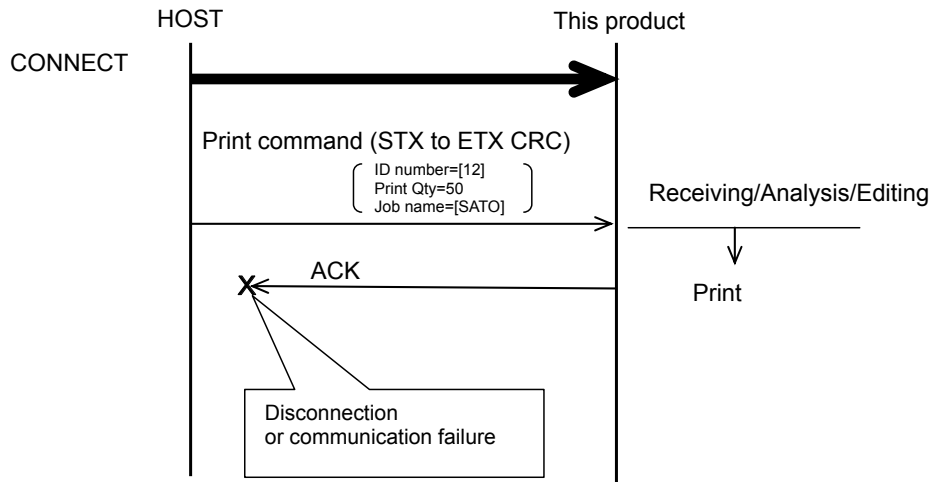

Note

- When ACK is not returned after sending print data, it shall be regarded as communication failure and sending print data has to be stopped.
- ACK may not return when communication through Bluetooth is disconnected before this product returns ACK.

CRC check is disabled (Common in status3 and status 4)

Works the same as the previously mentioned "CRC check enabled".

Abnormal end when CRC check is enabled

In the event of CRC error (Common in status 3 and status 4)

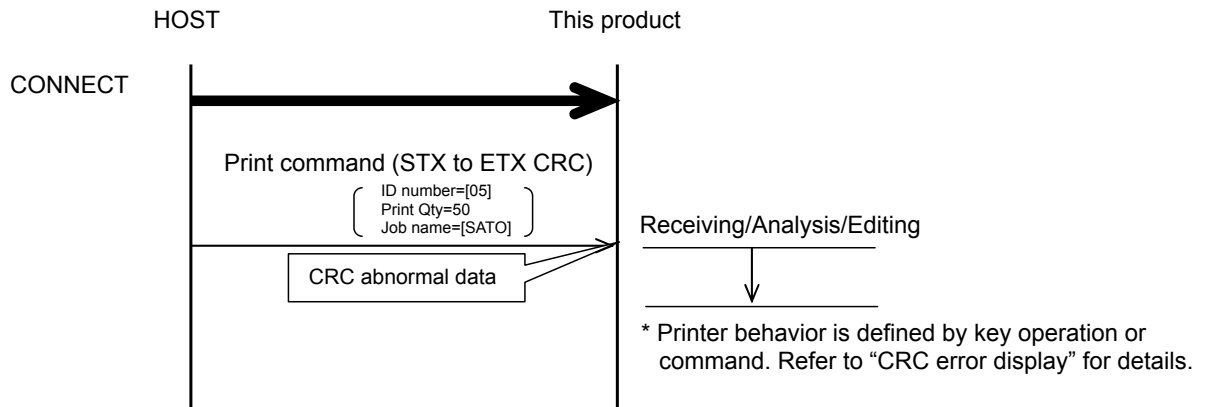

Note

- Received data is cleared and ACK/NAK is not returned when the received printer data has CRC error.

In the event of disconnection time-out (Common in status3 and status 4)

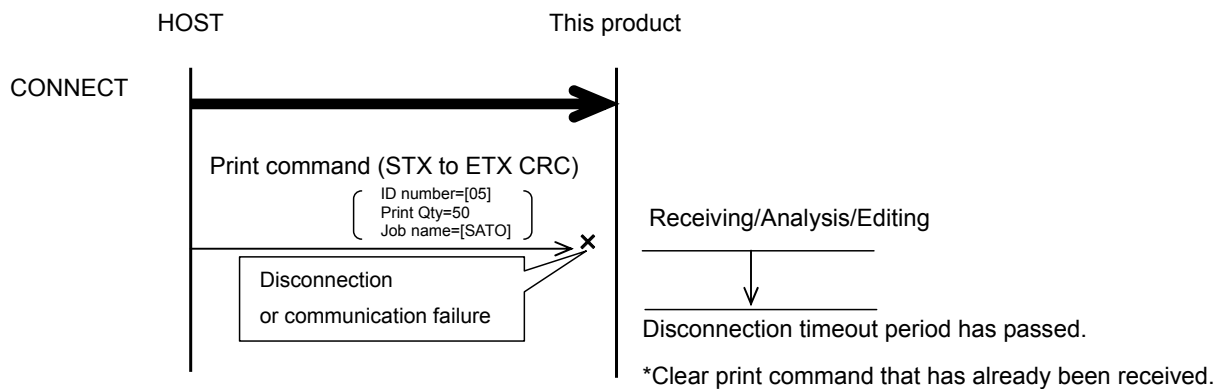

Note

- In case where receive data is not available in communication time-out period (10 sec) while receiving print command, time-out occurs to clear print data that has already been received. (ACK/NAK is not returned)

NFC

Basic specification

Interface standard

NFC forum Type 2 Tag compliant

Communication distance

Height from center of antenna (at a mark of NFC antenna) is 0 mm: right and left ± 5 mm

Height from center of antenna (at a mark of NFC antenna) is +10 mm: within the range of ± 10 mm to both right and left

Baud rate of Wireless part

106 Kbps

Interface

No interface

* Automated recognition of module after Factory clear

Enable/Disable setting in Service mode (Module operation), Interface mode (Communication behavior)

Operation mode

Power OFF: Tag mode (Write NDEF format to NFC tag)

Power ON: Pass through mode, Bluetooth/Wi-Fi handover

Communication disconnection time-out

1 second

NFC receive buffer capacity

Tag mode: 888 bytes (Overall NFC tag memory)

Pass through mode: 51,200 bytes

* The maximum communication volume in pass through mode.

Ex) In pass through mode, communication volume at a time is 50 Kbytes or less. ("NG" is returned if the communication volume is 50 Kbytes or more then receive data will be discarded)

Receive buffer size

2.95 MB

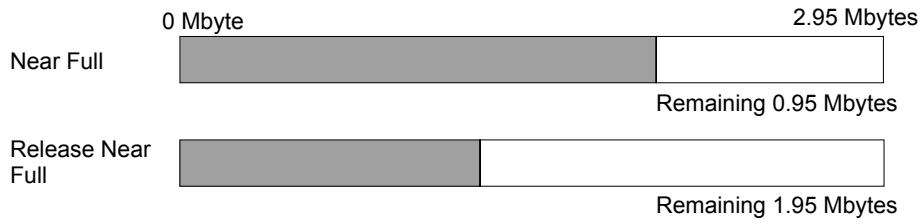

[Supplementary Explanation]

- NFC interface of this printer uses NT3H1101 provided by NXP Semiconductors. It does not support single bytes command (Status communication).

NFC allocation on printer

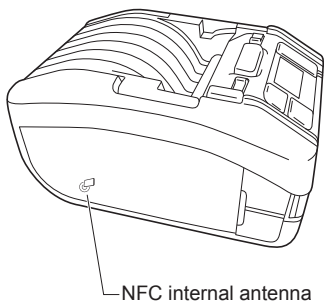

Tag mode

This tag mode works when the power of printer is turned off.

It performs read/write from/to NFC tag memory (888 bytes).

Information on printer is written to NFC tag memory when the power of printer is turned off so that device can obtain the information.

When the information on printer is written to NFC tag memory, the content of NFC tag memory is sent to printer after turning on the power of printer.

Purpose: Printer setting, Information acquisition

Note

It is necessary to read information on device before writing to acquire information on device because area to be used for reading and writing is the same.

Valid range of NFC tag memory is 800 bytes.

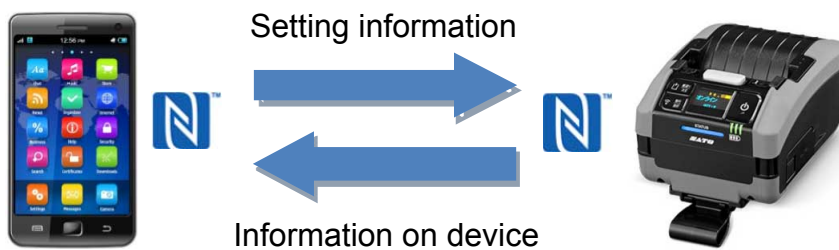

Data format

Send data format

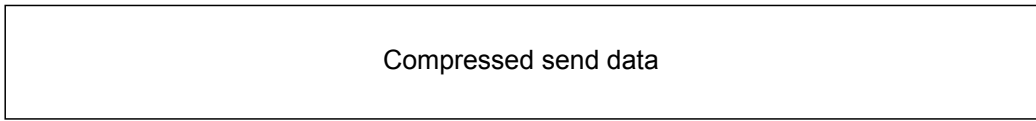

Set send data after it is compressed with zlib.

The maximum size of compressed send data is 800 bytes.

Received data format

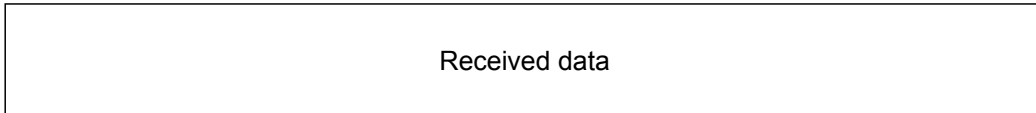

Receive data is uncompressed text data.

Transmission sequence

Normal end

Following shows the example of sequence for sending and receiving data.

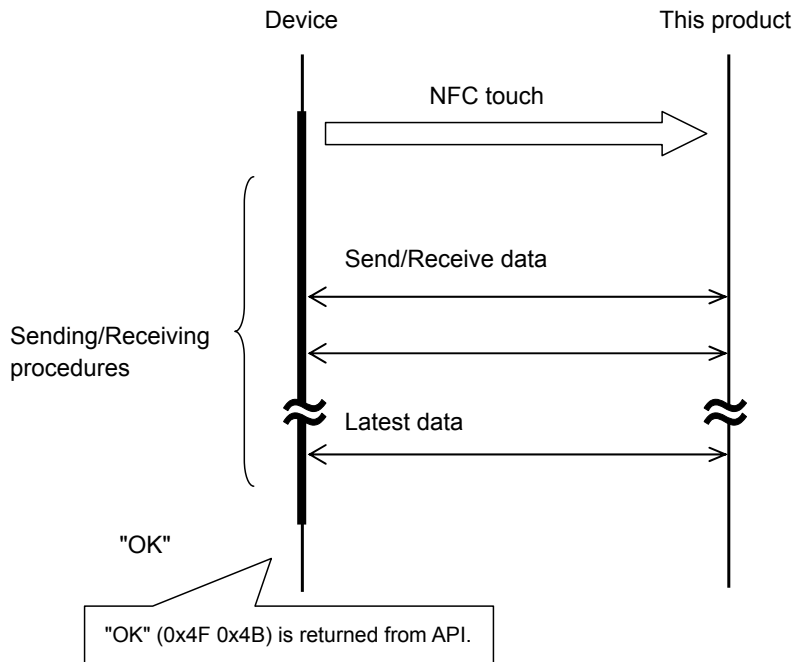

Abnormal End

"NG" is returned from API when there is communication error or tag memory error.

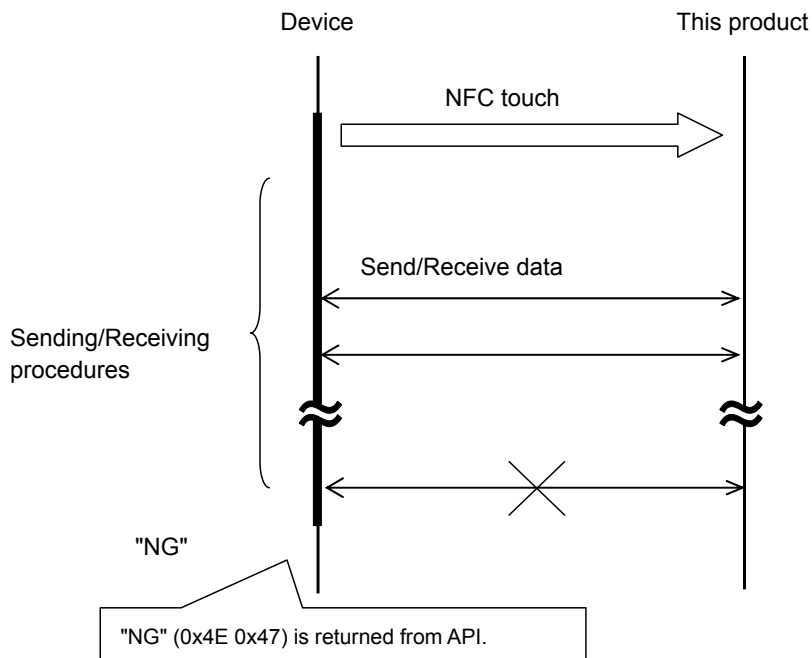

Pass-through mode

Pass-through mode works when the power of printer is turned on.

Provides communication with printer via NFC tag.

Data communication is performed in between NFC device and NFC tag. The data is zipped and unzipped by NFC controller and is sent to printer directly (through).

Purpose: Send small SBPL data (Print), Acquisition of printer setting, value, status.

* Small data here is about 1000 bytes (Assuming that device can hold this small data for two seconds or less due to the operation. 8 Kbps from actual measurement). Handover mode is recommended to handle data which is larger than 1000 bytes.

Note

If you are using NFC with printer is having near full operation (2 MB or more for printer receive buffer), please check the status of buffer (RS parameter) with DC2+PG command and control transmission (do not send print data until buffer near full is released) because this is not bidirectional communication.

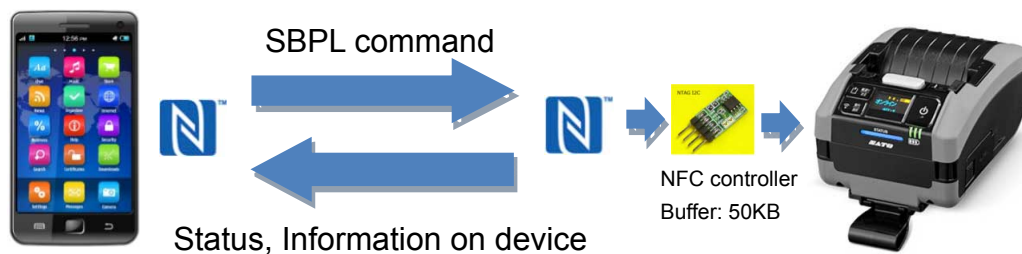

Data format

Sent and received data format

(1) Number of data byte 4 bytes	(2) Compressed send and received data	(3) CRC 2 bytes
--	--	-----------------------

(1) Number of send and received byte

Set the number of compressed send and received data byte to big endian.

(2) Compressed send and received data

Set send and received data after it is compressed with zlib.

The maximum data size before compression is 51200 bytes.

(3) CRC

Set CRC of send and received data before compression. Use CRC-16-CCITT for CRC.

Please refer to "CRC-16 CCITT" to be described hereinafter for the details.

Transmission sequence

Normal end

Following shows an example of sequence for sending and receiving data.

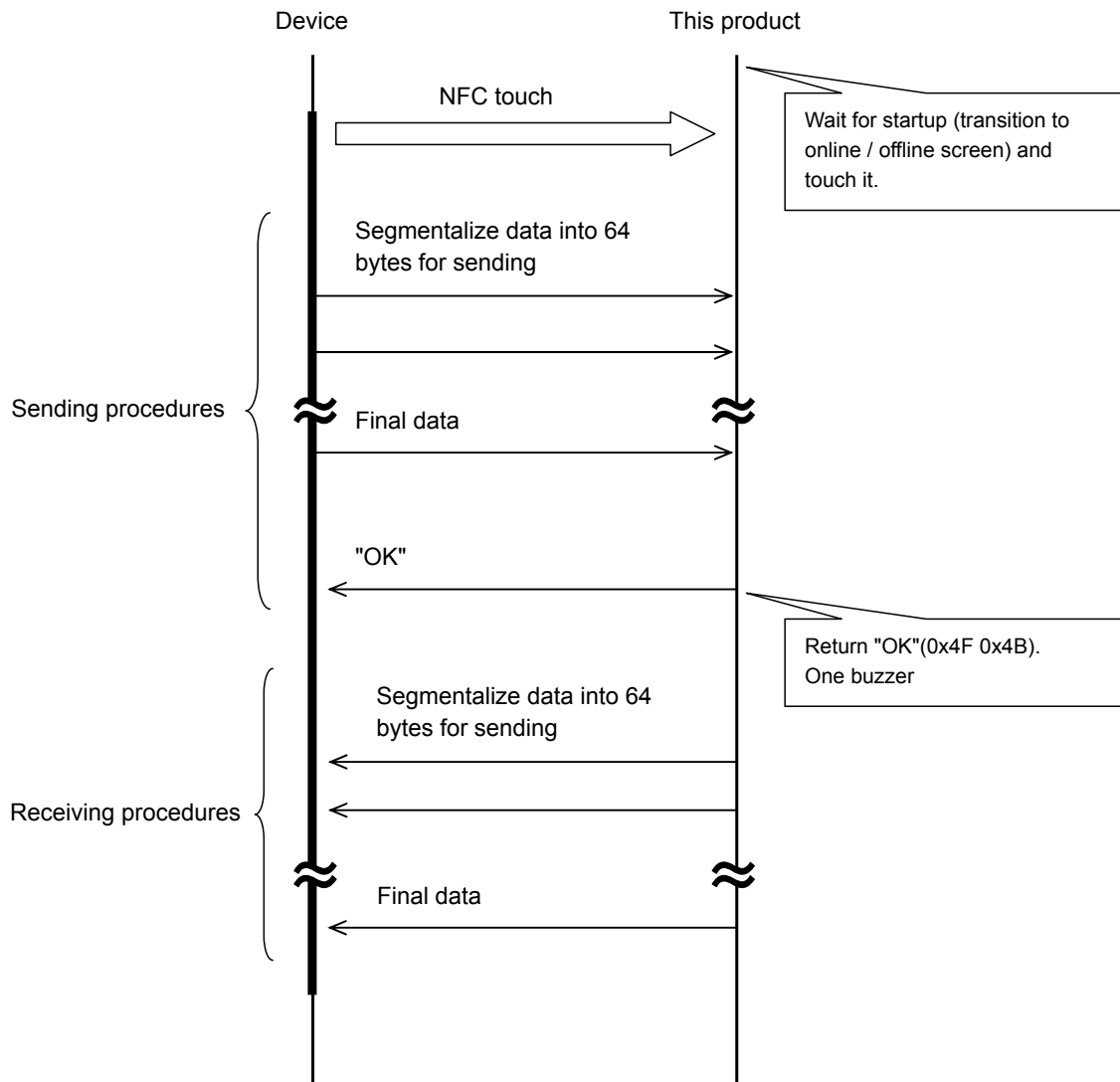

When a device is moved away from this product while the device is sending data to the product

This product will discard the received data.

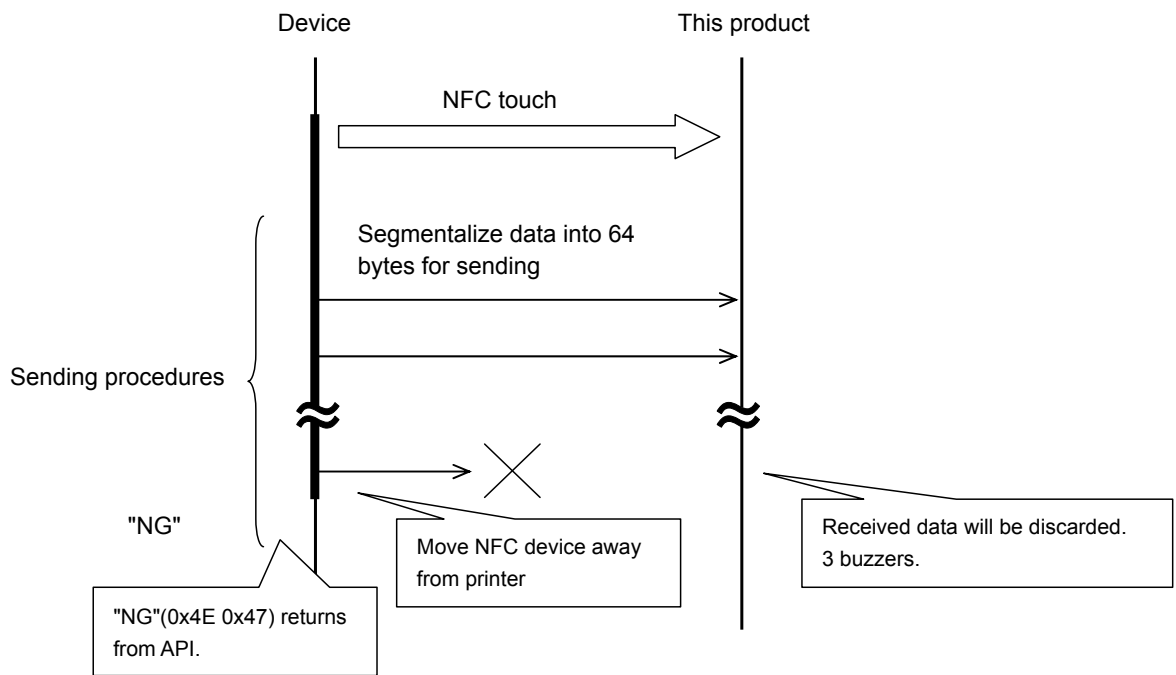

When a device is moved away from this product while the device is receiving data from the product

This product will discard send data.

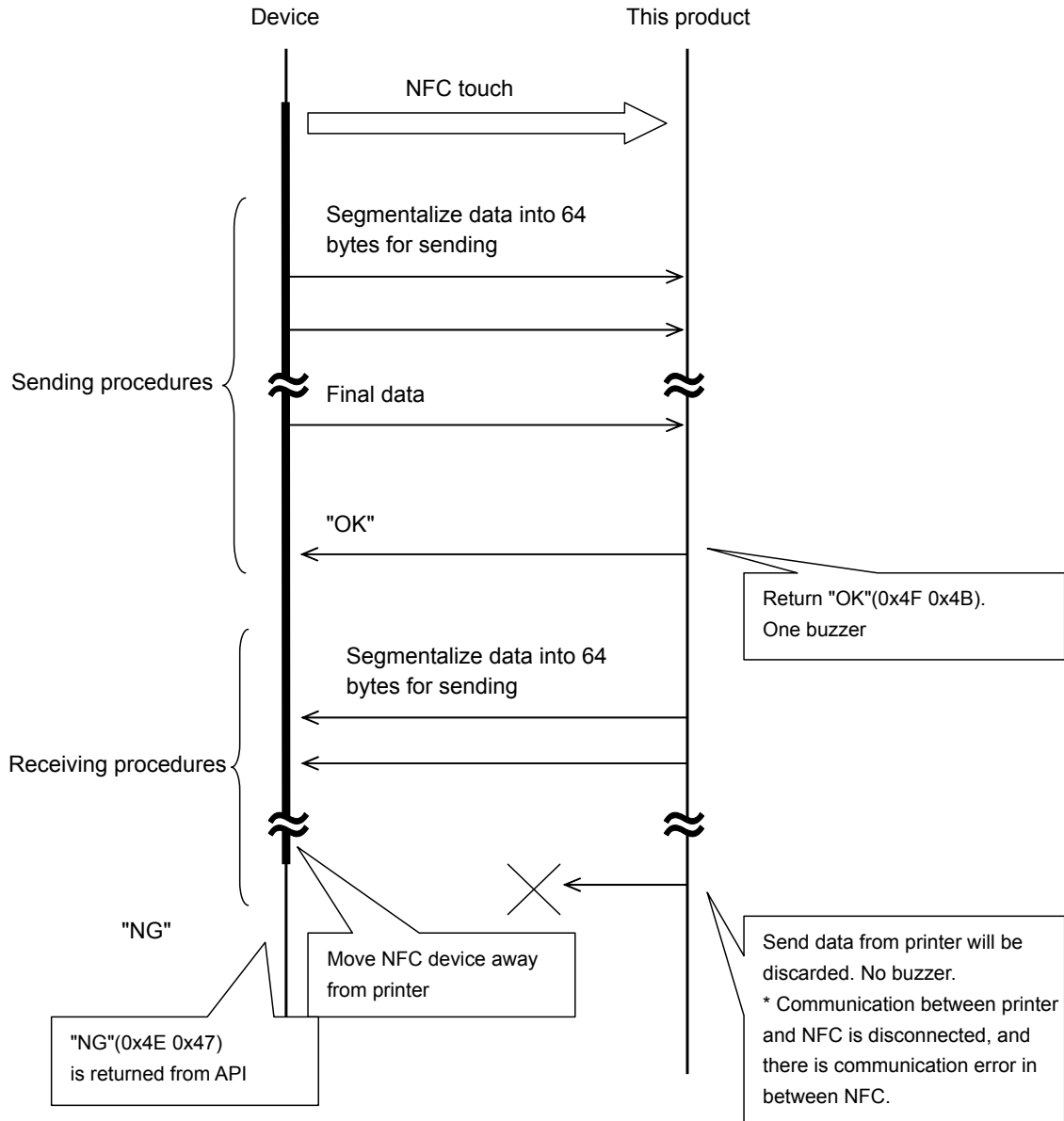

When CRC error occurs

This product will discard received data from printer then return "NG_CRCCHECK".

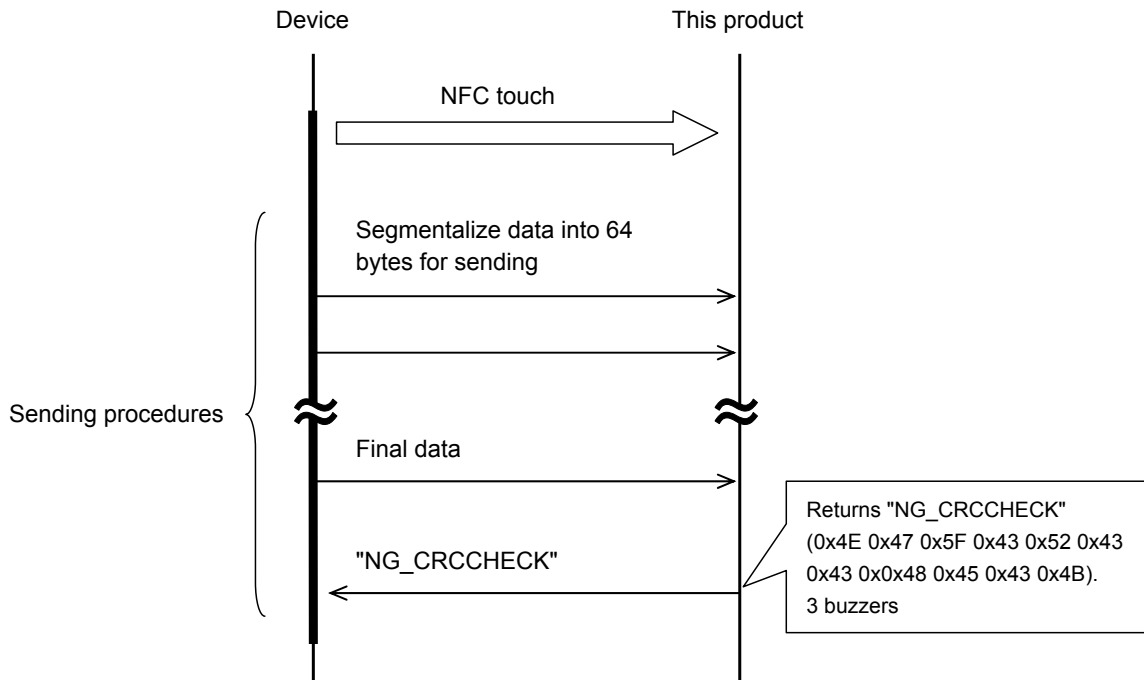

When NFC communication buffer over error occurs

This product will discard received data then return "NG_OTHER".

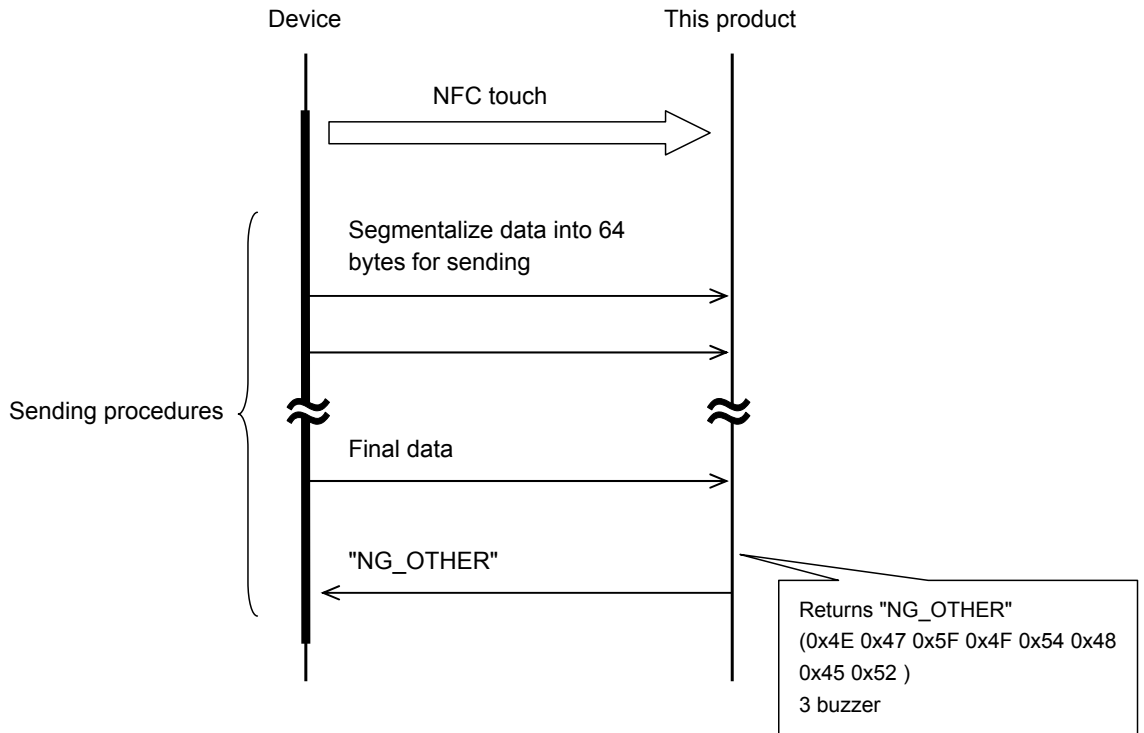

CRC-16-CCITT

Calculation range of CRC

Send and received data before compression is the calculation range.

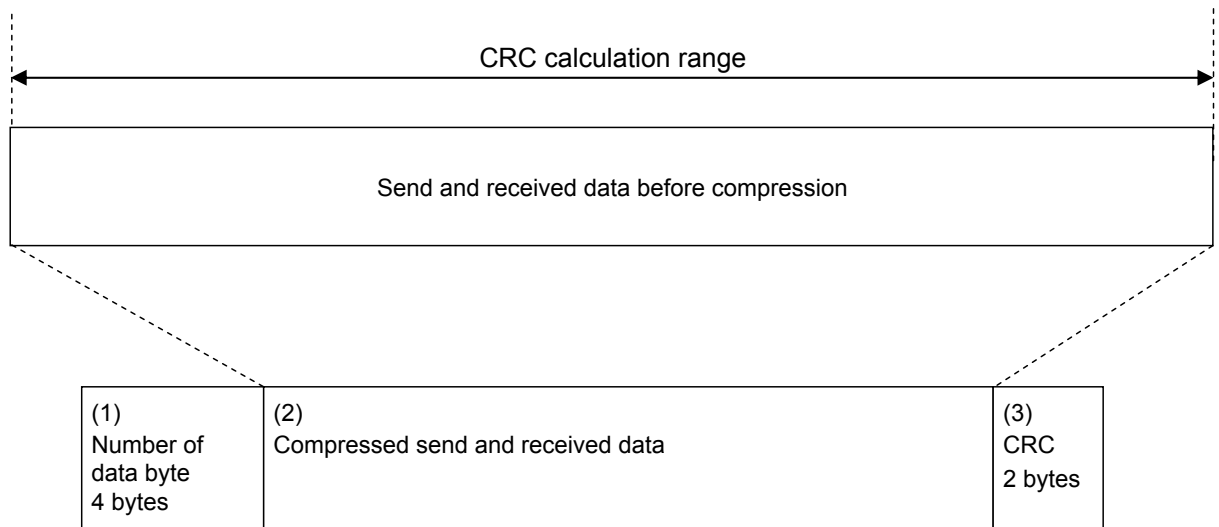

Method for calculating CRC

Use CRC-16-CCITT for calculating CRC.

Polynomial: $X^{16}+X^{12}+X^5+X^0$

Initial value: 0xFFFF

Following page shows an example of programming.

```

/* CRCtable */
unsigned short CRC16Table[ 256 ] = {
    0x0000, 0x1021, 0x2042, 0x3063, 0x4084, 0x50A5, 0x60C6, 0x70E7,
    0x8108, 0x9129, 0xA14A, 0xB16B, 0xC18C, 0xD1AD, 0xE1CE, 0xF1EF,
    0x1231, 0x0210, 0x3273, 0x2252, 0x52B5, 0x4294, 0x72F7, 0x62D6,
    0x9339, 0x8318, 0xB37B, 0xA35A, 0xD3BD, 0xC39C, 0xF3FF, 0xE3DE,
    0x2462, 0x3443, 0x0420, 0x1401, 0x64E6, 0x74C7, 0x44A4, 0x5485,
    0xA56A, 0xB54B, 0x8528, 0x9509, 0xE5EE, 0xF5CF, 0xC5AC, 0xD58D,
    0x3653, 0x2672, 0x1611, 0x0630, 0x76D7, 0x66F6, 0x5695, 0x46B4,
    0xB75B, 0xA77A, 0x9719, 0x8738, 0xF7DF, 0xE7FE, 0xD79D, 0xC7BC,
    0x48C4, 0x58E5, 0x6886, 0x78A7, 0x0840, 0x1861, 0x2802, 0x3823,
    0xC9CC, 0xD9ED, 0xE98E, 0xF9AF, 0x8948, 0x9969, 0xA90A, 0xB92B,
    0x5AF5, 0x4AD4, 0x7AB7, 0x6A96, 0x1A71, 0x0A50, 0x3A33, 0x2A12,
    0xDBFD, 0xCBDC, 0xFBBF, 0xEB9E, 0x9B79, 0x8B58, 0xBB3B, 0xAB1A,
    0x6CA6, 0x7C87, 0x4CE4, 0x5CC5, 0x2C22, 0x3C03, 0x0C60, 0x1C41,
    0xEDAE, 0xFD8F, 0xCDEC, 0xDDCD, 0xAD2A, 0xBD0B, 0x8D68, 0x9D49,
    0x7E97, 0x6EB6, 0x5ED5, 0x4EF4, 0x3E13, 0x2E32, 0x1E51, 0x0E70,
    0xFF9F, 0xEFBE, 0xDFDD, 0xCFFC, 0xBF1B, 0xAF3A, 0x9F59, 0x8F78,
    0x9188, 0x81A9, 0xB1CA, 0xA1EB, 0xD10C, 0xC12D, 0xF14E, 0xE16F,
    0x1080, 0x00A1, 0x30C2, 0x20E3, 0x5004, 0x4025, 0x7046, 0x6067,
    0x83B9, 0x9398, 0xA3FB, 0xB3DA, 0xC33D, 0xD31C, 0xE37F, 0xF35E,
    0x02B1, 0x1290, 0x22F3, 0x32D2, 0x4235, 0x5214, 0x6277, 0x7256,
    0xB5EA, 0xA5CB, 0x95A8, 0x8589, 0xF56E, 0xE54F, 0xD52C, 0xC50D,
    0x34E2, 0x24C3, 0x14A0, 0x0481, 0x7466, 0x6447, 0x5424, 0x4405,
    0xA7DB, 0xB7FA, 0x8799, 0x97B8, 0xE75F, 0xF77E, 0xC71D, 0xD73C,
    0x26D3, 0x36F2, 0x0691, 0x16B0, 0x6657, 0x7676, 0x4615, 0x5634,
    0xD94C, 0xC96D, 0xF90E, 0xE92F, 0x99C8, 0x89E9, 0xB98A, 0xA9AB,
    0x5844, 0x4865, 0x7806, 0x6827, 0x18C0, 0x08E1, 0x3882, 0x28A3,
    0xCB7D, 0xDB5C, 0xEB3F, 0xFB1E, 0x8BF9, 0x9BD8, 0xABBB, 0xBB9A,
    0x4A75, 0x5A54, 0x6A37, 0x7A16, 0x0AF1, 0x1AD0, 0x2AB3, 0x3A92,
    0xFD2E, 0xED0F, 0xDD6C, 0xCD4D, 0xBDAA, 0xAD8B, 0x9DE8, 0x8DC9,
    0x7C26, 0x6C07, 0x5C64, 0x4C45, 0x3CA2, 0x2C83, 0x1CE0, 0x0CC1,
    0xEF1F, 0xFF3E, 0xCF5D, 0xDF7C, 0xAF9B, 0xBFBA, 0x8FD9, 0x9FF8,
    0x6E17, 0x7E36, 0x4E55, 0x5E74, 0x2E93, 0x3EB2, 0x0ED1, 0x1EF0,
};

/* Function to calculate CRC */
unsigned short crc16(unsigned char *buffer, unsigned int size){
    unsigned short crc = 0xFFFF;
    while(size--){
        crc = CRC16Table[((crc>>8)^(*buffer++))&0xFF] ^ (crc<<8);
    }
    return crc;
}

```

Handover mode

This mode works when the power of printer is turned on.

Read information on handover (Bluetooth, Wi-Fi connection), which is written to NFC tag memory when the power of printer is turned OFF, from NFC tag memory, then connection is established with Bluetooth or Wi-Fi based on the information.

Purpose: Send SBPL data (Print), Acquisition of printer setting, value, and status.

* Communication after connecting Handover shall be performed via Bluetooth or Wi-Fi.

Please refer to "Bluetooth" or "Wireless LAN" described before for data format and transmission sequence.

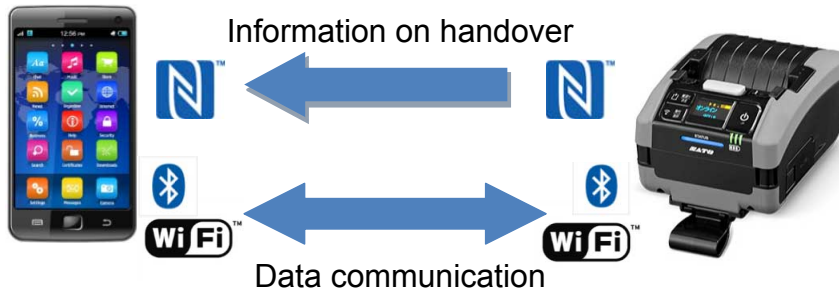

Notes about the Interface

Behavior after turning off the printer

Please note that the data sent from host to printer will not be guaranteed after shutting down a printer.

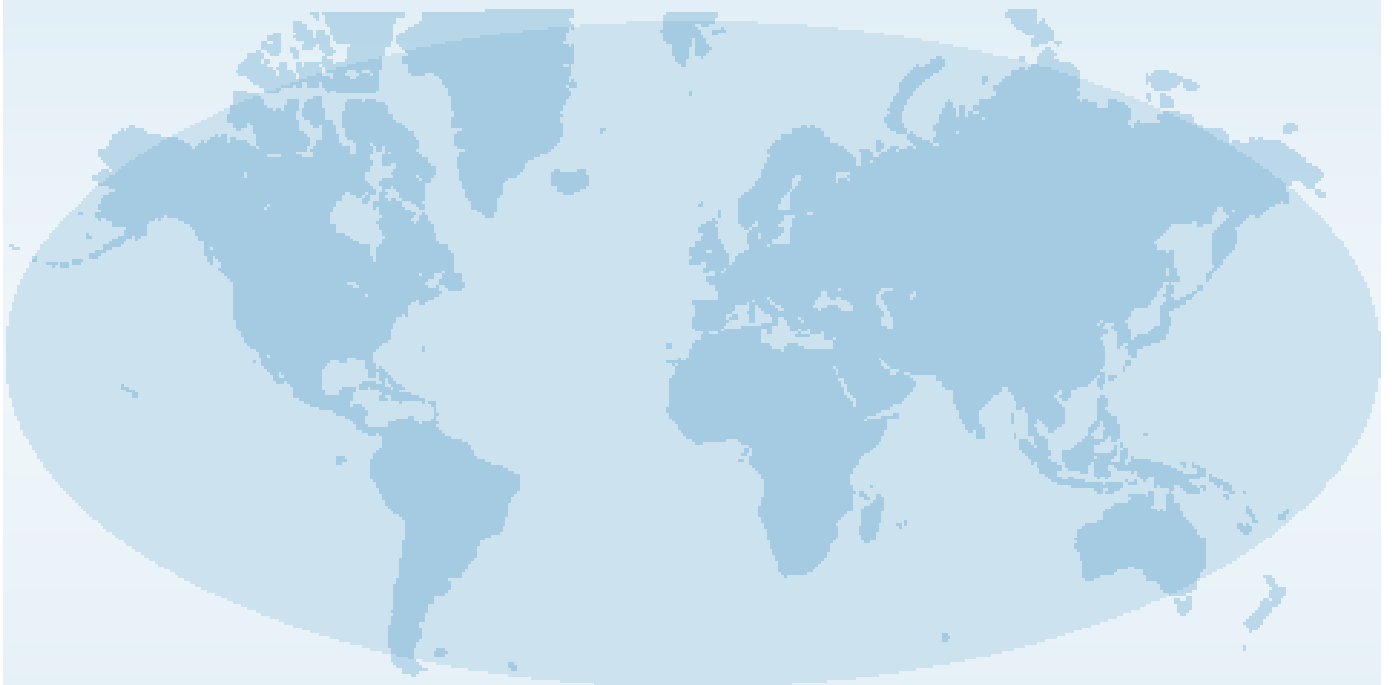

Extensive contact information for worldwide SATO operations can be found on the Internet at www.satoworldwide.com

SATO